

US00D396716S

# United States Patent [19]

Matsuda et al.

[11] Patent Number: **Des. 396,716**

[45] Date of Patent: **\*\*Aug. 4, 1998**

[54] **SPEAKER PHONE**

[75] Inventors: **Hari Matsuda**, Evantson, Ill.; **Rick T. Mason**, Westland, Mich.; **Frank J. Annerino**, Rolling Meadows, Ill.

[73] Assignee: **3Com Corporation**, Santa Clara, Calif.

[\*\*] Term: **14 Years**

[21] Appl. No.: **78,195**

[22] Filed: **Oct. 21, 1997**

[51] LOC (6) Cl. .... **14-03**

[52] U.S. Cl. .... **D14/150; D14/243**

[58] Field of Search ..... D14/137, 138, D14/148, 149-151, 240, 243, 140-142; 379/433-436, 419, 420, 428, 440, 388, 390, 406, 410; D21/48

[56] **References Cited**

**U.S. PATENT DOCUMENTS**

D. 304,335	10/1989	Chen	.....	D14/142
D. 307,274	4/1990	Sasaki et al.	.....	D14/243
D. 342,732	12/1993	Hinman et al.	.....	D14/150
D. 346,598	5/1994	McCan et al.	.....	D14/137
D. 355,416	2/1995	McCan et al.	.....	D14/137
D. 373,585	9/1996	Nagele et al.	.....	D14/149

D. 382,265	8/1997	Bradley et al.	.....	D14/149
D. 382,266	8/1997	Wakefield	.....	D14/150
5,664,015	9/1997	Ford et al.	.....	379/420 X

**OTHER PUBLICATIONS**

Hello Direct on line, Siemens/Rolm PBX, www.hello-direct.com, Feb. 1998.

*Primary Examiner*—Jeffrey Asch  
*Attorney, Agent, or Firm*—McDonnell Boehnen Hulbert & Berghoff

[57] **CLAIM**

The ornamental design for a speaker phone, as shown and described.

**DESCRIPTION**

FIG. 1 is a perspective view of the speaker phone; FIG. 2 is a top plan view of the speaker phone; FIG. 3 is a bottom plan view of the speaker phone; FIG. 4 is a front elevational view of the speaker phone; FIG. 5 is a rear elevational view of the speaker phone; FIG. 6 is a side elevational view of the speaker phone, as seen from the right hand side of the machine; and, FIG. 7 is a side elevational view of the speakerphone, as seen from the left hand side of the machine.

**1 Claim, 3 Drawing Sheets**

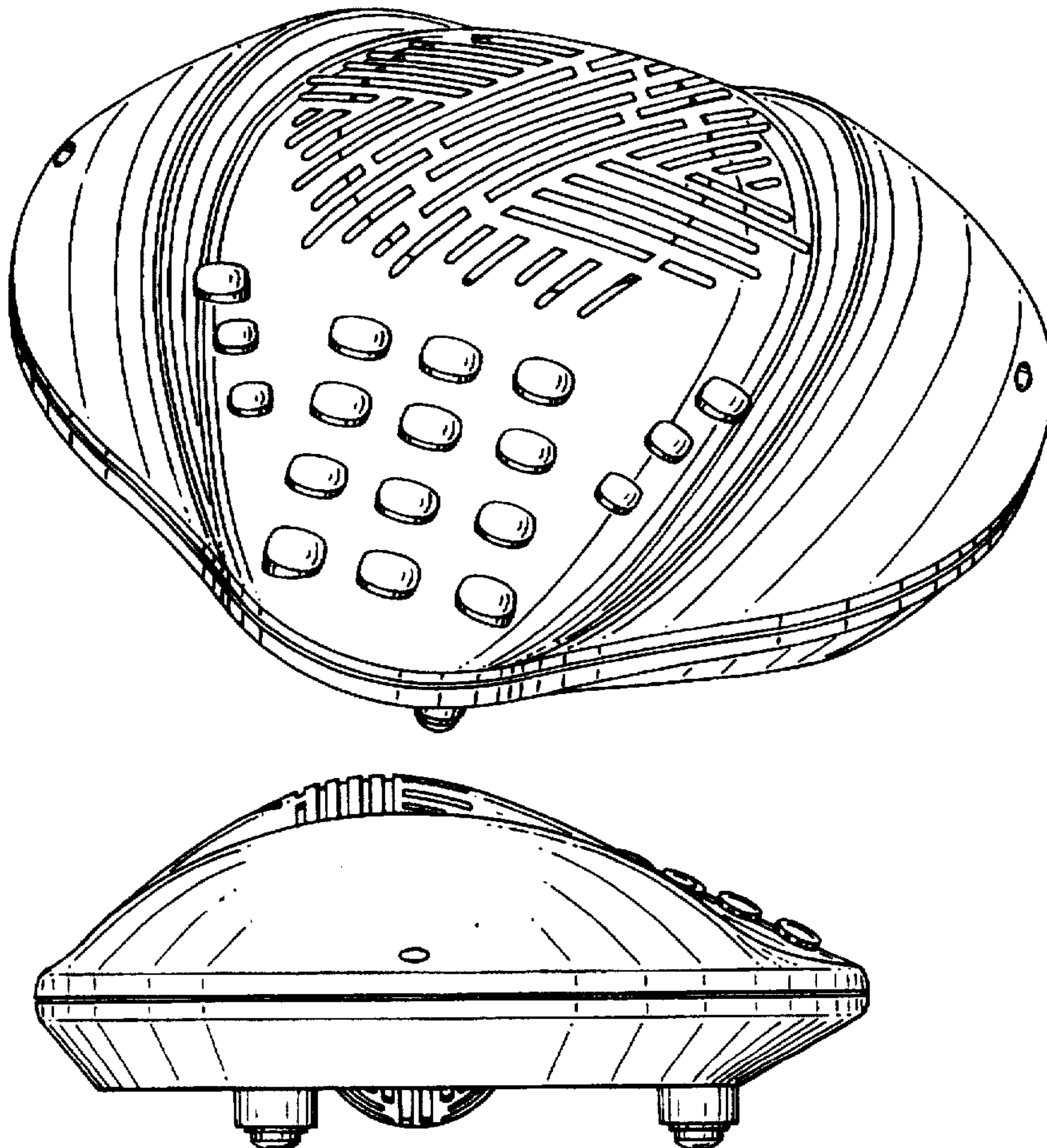

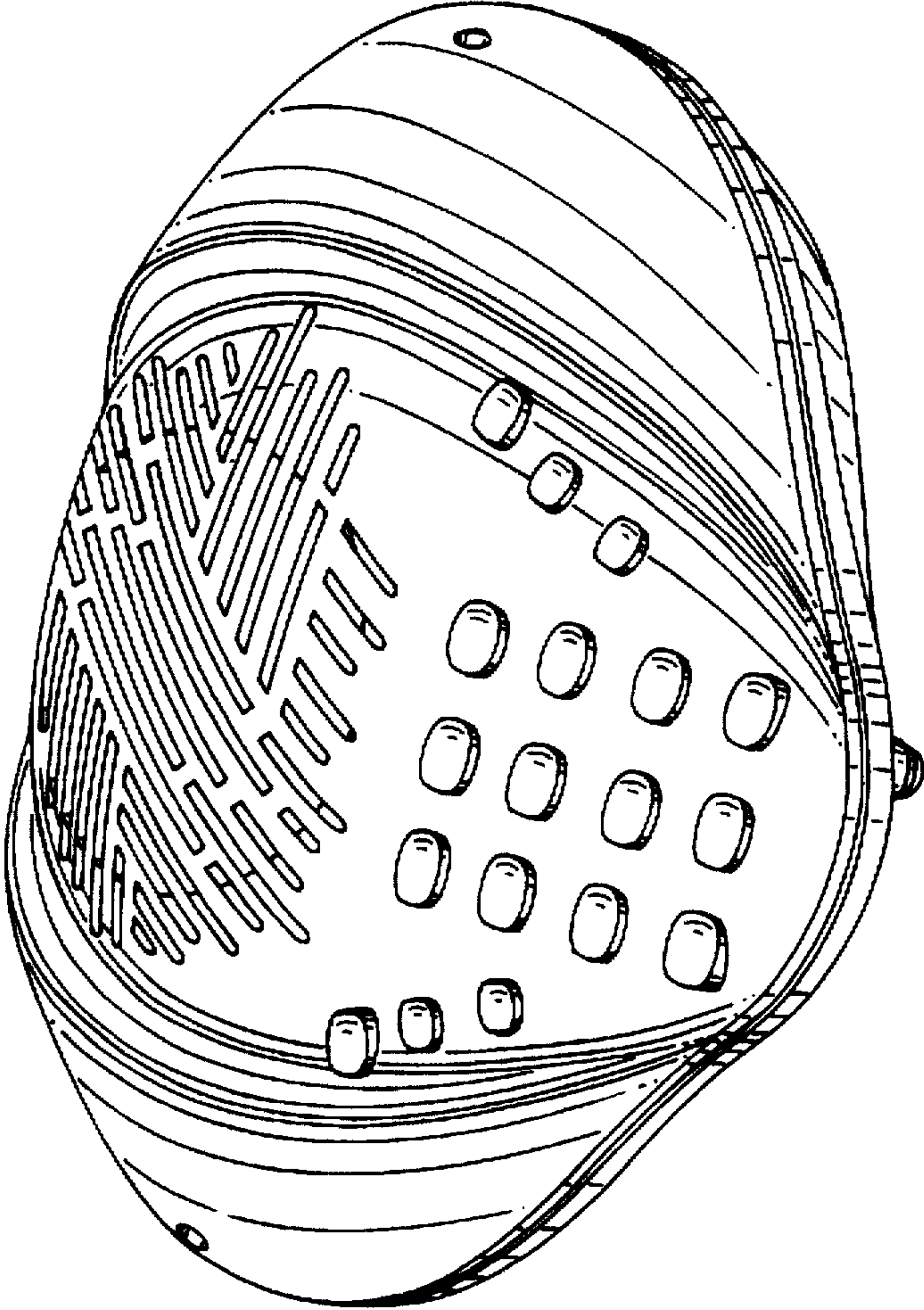

FIG. 1



FIG. 2

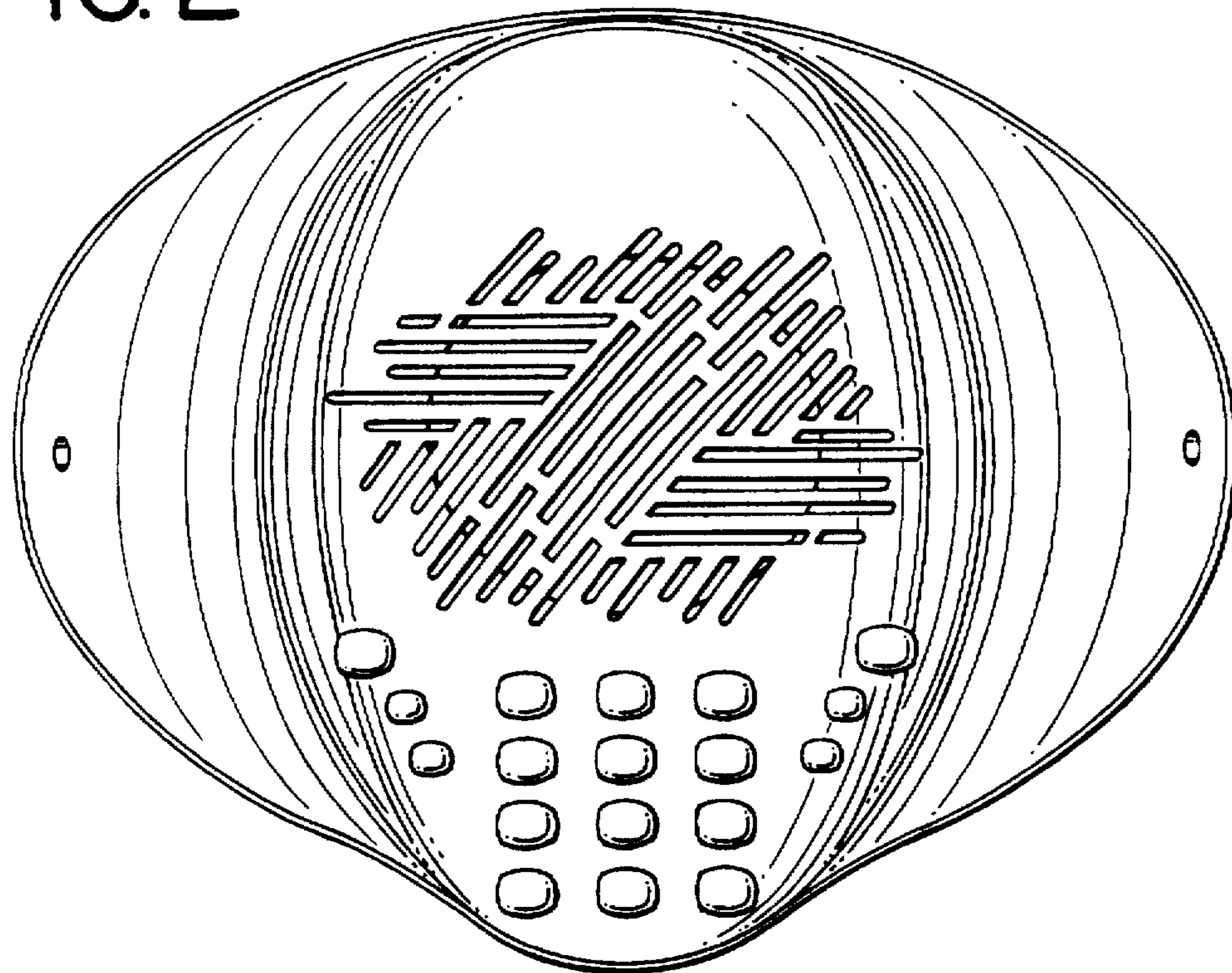

FIG. 3

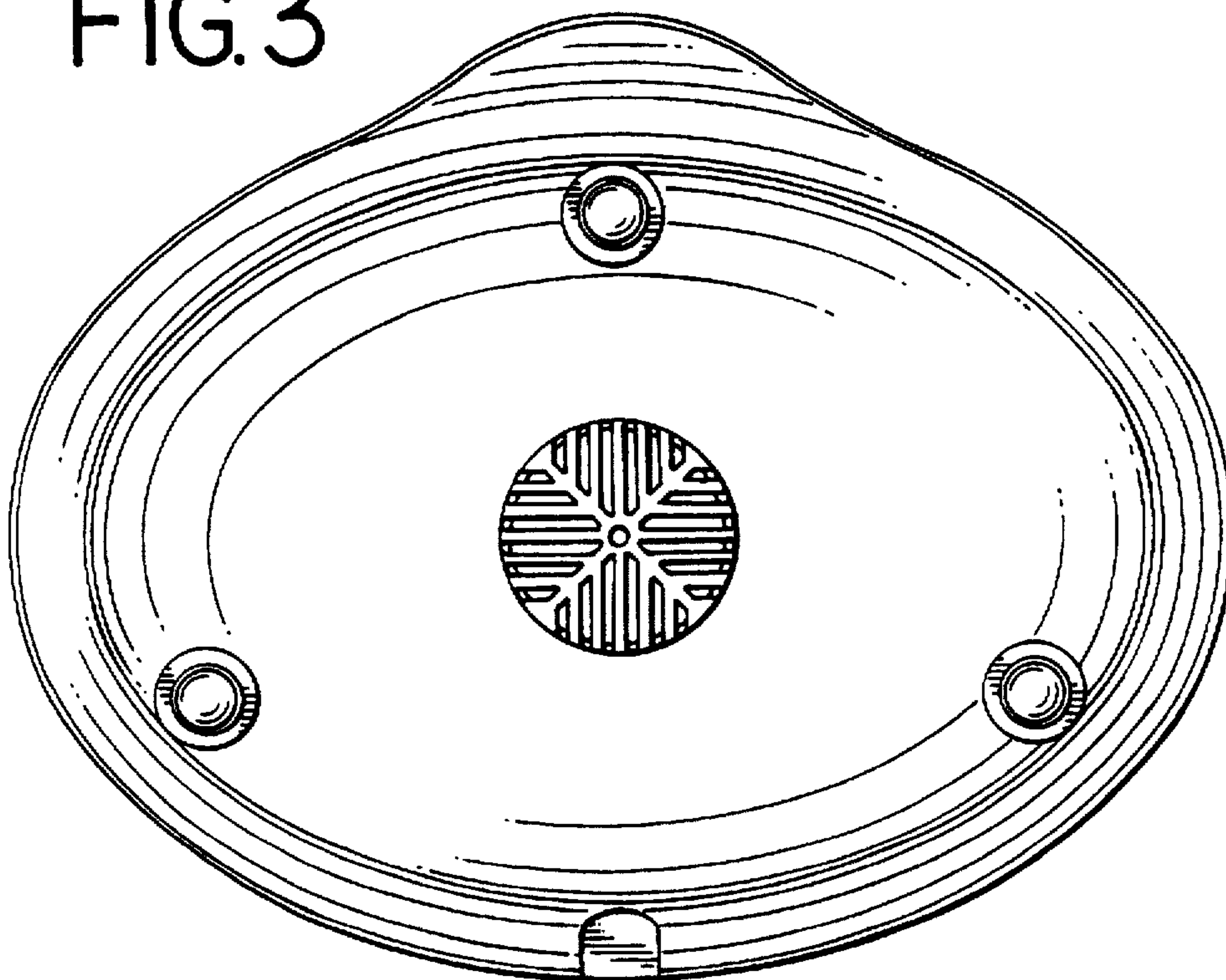

FIG. 4

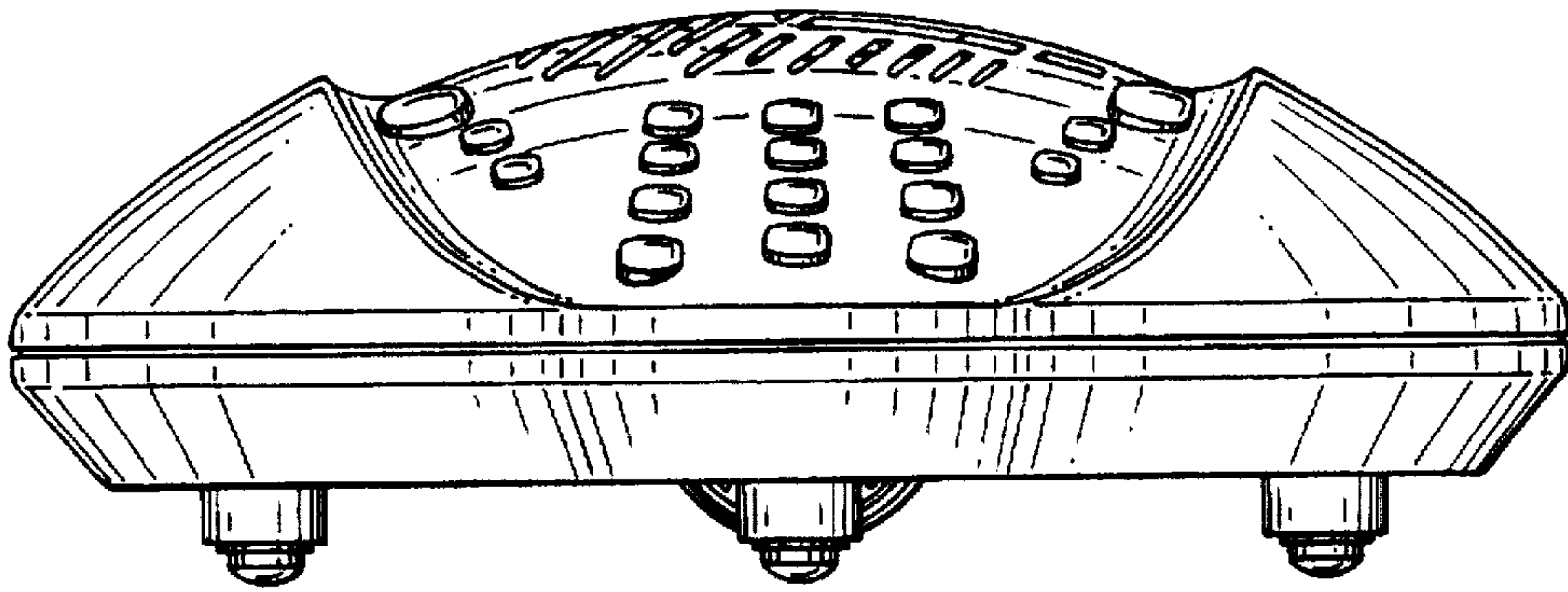

FIG. 5

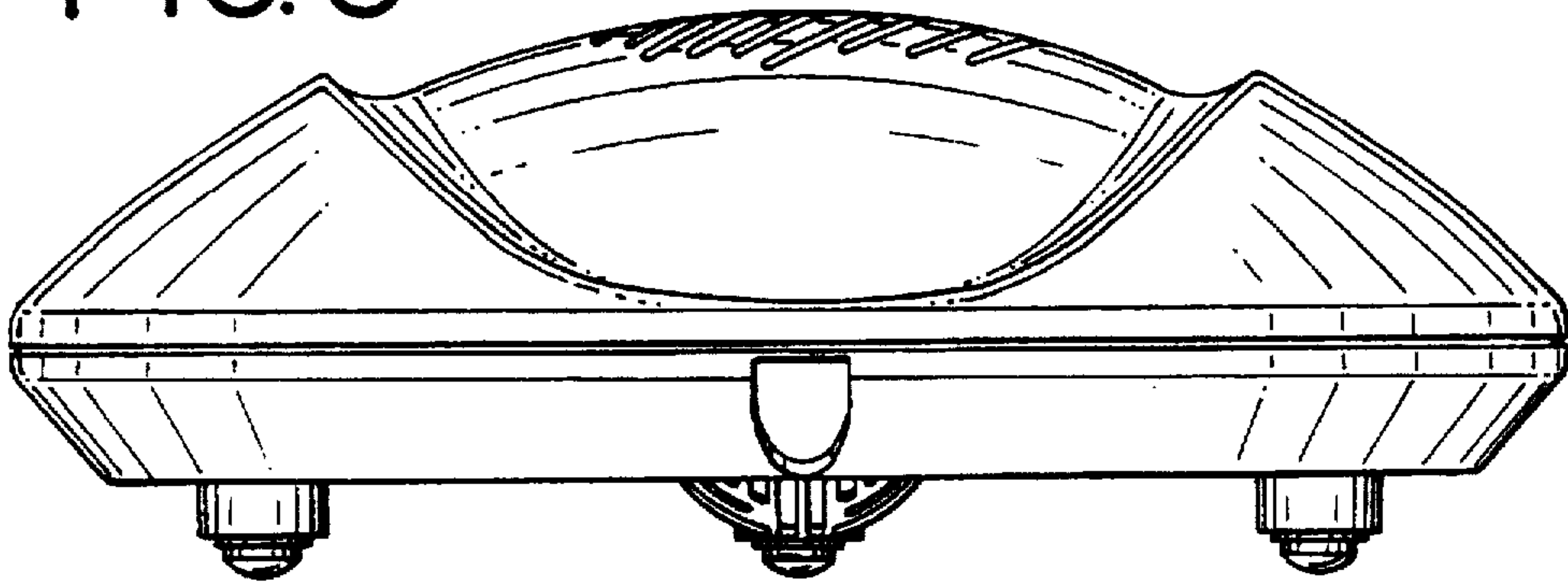

FIG. 6

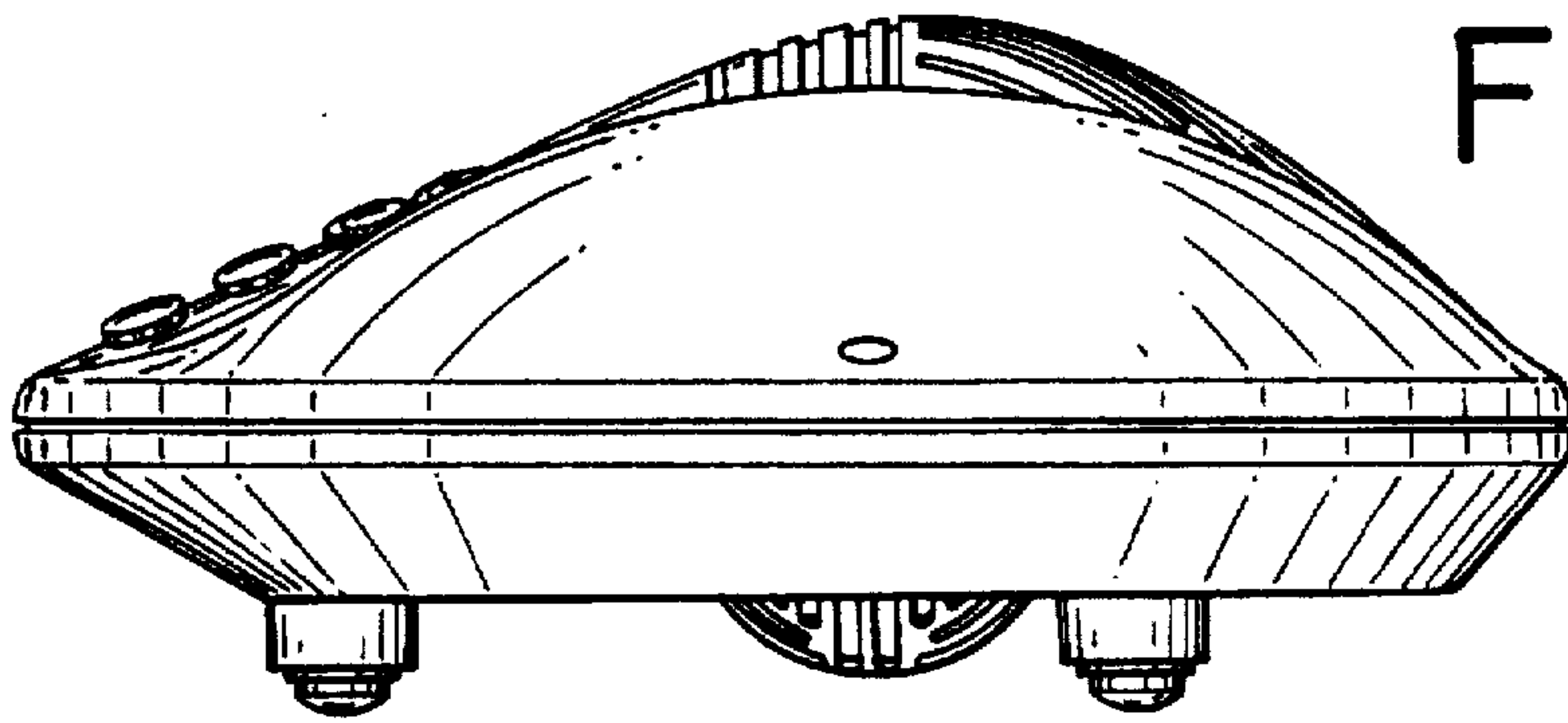

FIG. 7

