



US00D396484S

United States Patent [19]
Stables

[11] **Patent Number:** **Des. 396,484**
[45] **Date of Patent:** *****Jul. 28, 1998**

[54] **DESIGN FOR SUNGLASSES**

[75] **Inventor:** **Paul J. Stables, Pt. Clare, Australia**

[73] **Assignee:** **Australia Vision Services Pty. Ltd.,
Horsfield Bay, Australia**

[*] **Notice:** The portion of the term of this patent subsequent to Dec. 2, 2011, has been disclaimed.

[**] **Term:** **14 Years**

[21] **Appl. No.:** **57,707**

[22] **Filed:** **Jul. 30, 1996**

Related U.S. Application Data

[63] **Continuation-in-part of Ser. No. 46,208, Nov. 9, 1995, Pat. No. Des. 387,083.**

[30] **Foreign Application Priority Data**

May 26, 1995 [AU] Australia 1635/95

[51] **LOC (6) Cl.** **16-06**

[52] **U.S. Cl.** **D16/326; D16/325**

[58] **Field of Search** **D16/300, 302, D16/304, 306-307, 309-318, 321, 323-330, 335-337, 339, 340, 900; D29/109, 110; 2/428, 432, 430, 436, 444, 448, 449; 351/41, 44, 51-52, 57-61, 123, 156-158, 121-122, 153**

[56] **References Cited**

U.S. PATENT DOCUMENTS

D. 112,946 1/1939 Brunetti .
D. 201,920 8/1965 McCullogh .

D. 293,328 12/1987 Murphy et al. .
D. 335,133 4/1993 Langley .
4,976,530 12/1990 MacKay et al. .
5,218,385 6/1993 Lii .
5,463,428 10/1995 Lipton et al. .

OTHER PUBLICATIONS

Washington Post, Parade Magazine, May 10, 1992 (Glasses in middle of page).

Primary Examiner—Raphael Barkai
Attorney, Agent, or Firm—Oppenheimer Wolff & Donnelly LLP

[57] **CLAIM**

The ornamental design for sunglasses, as shown and described.

DESCRIPTION

FIG. 1 is a front view of sunglasses showing this new design; FIG. 2 is a perspective front view thereof; FIG. 3 is a plan view thereof; FIG. 4 is a bottom plan view thereof; FIG. 5 is a right side view thereof, the side opposite being a mirror image; FIG. 6 is a rear view thereof; FIG. 7 is a perspective rear view thereof; FIG. 8 is a front view of a second embodiment of FIG. 1; FIG. 9 is a perspective front view thereof; FIG. 10 is a plan view thereof; FIG. 11 is a bottom plan view thereof; FIG. 12 is a right side view thereof, the side opposite being a mirror image; FIG. 13 is a rear view thereof; and, FIG. 14 is a perspective rear view thereof.

1 Claim, 8 Drawing Sheets

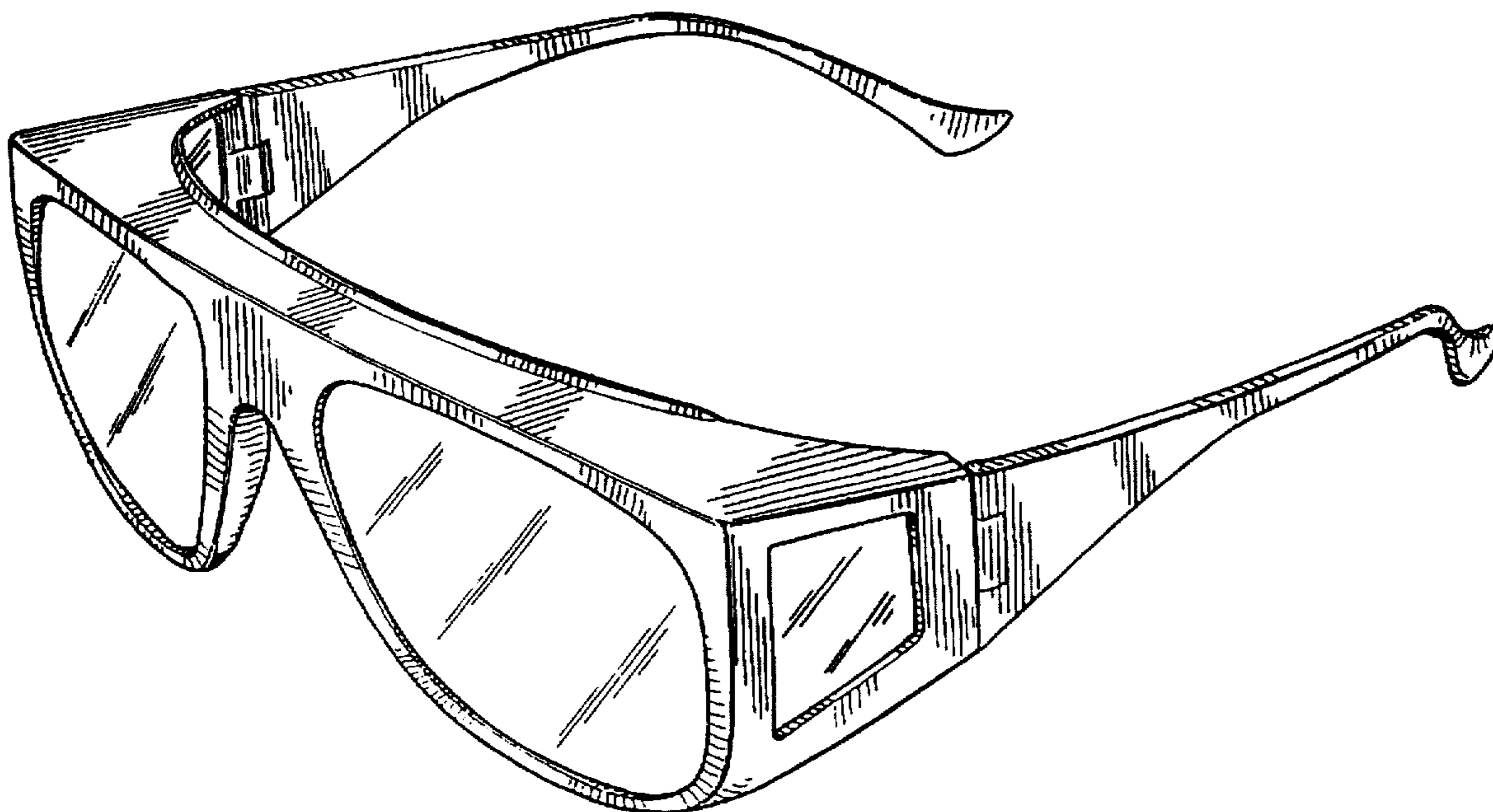

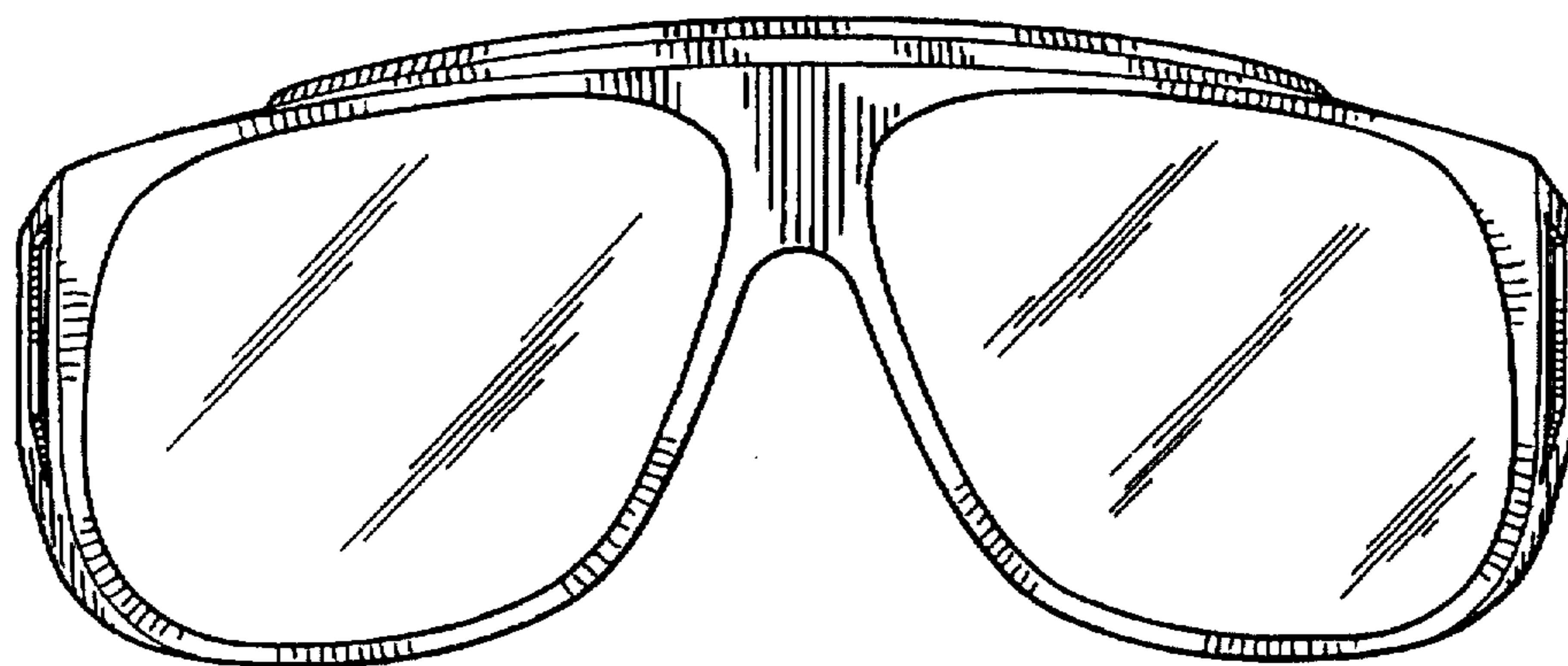

FIG. 1

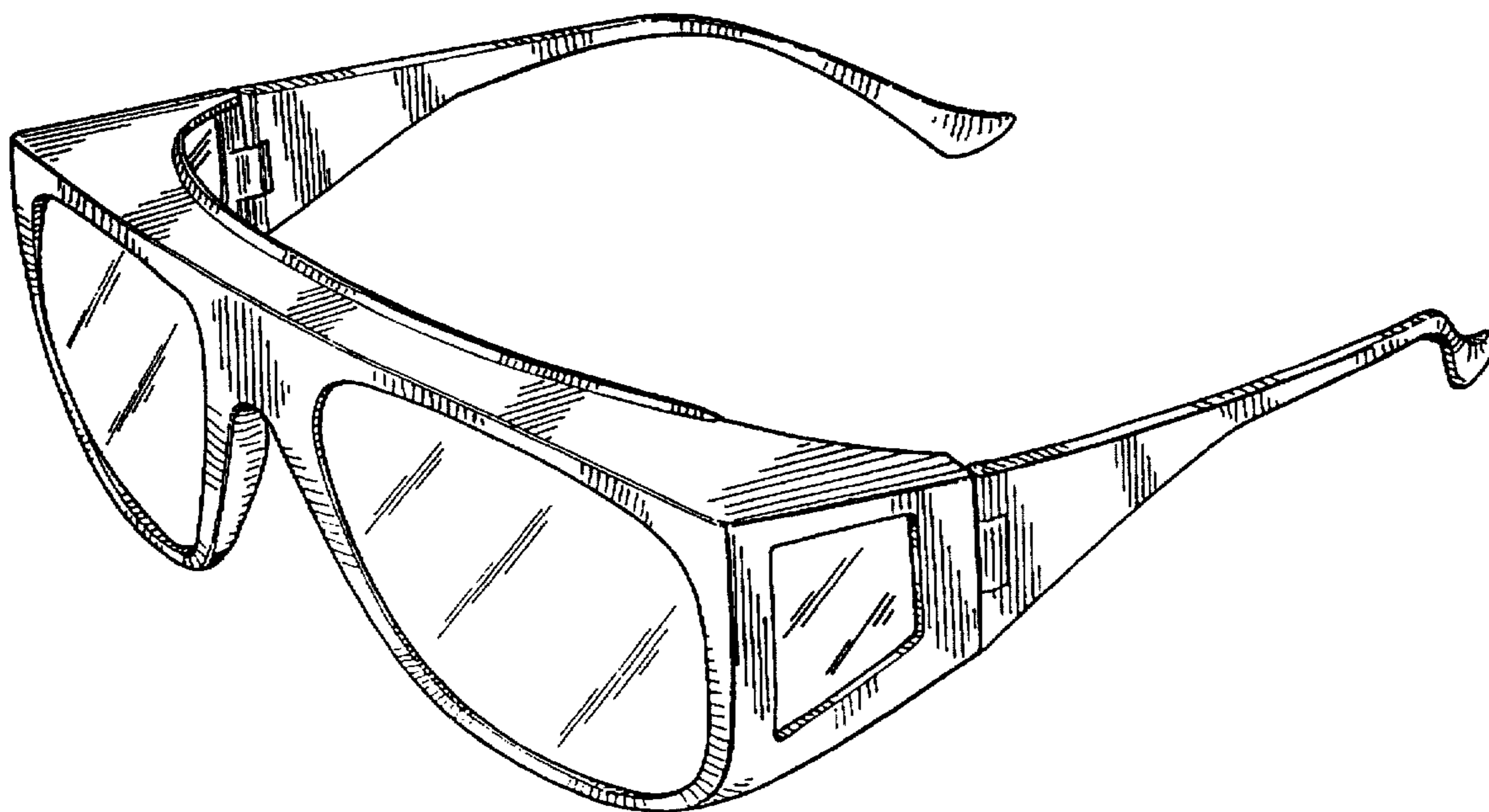

FIG. 2

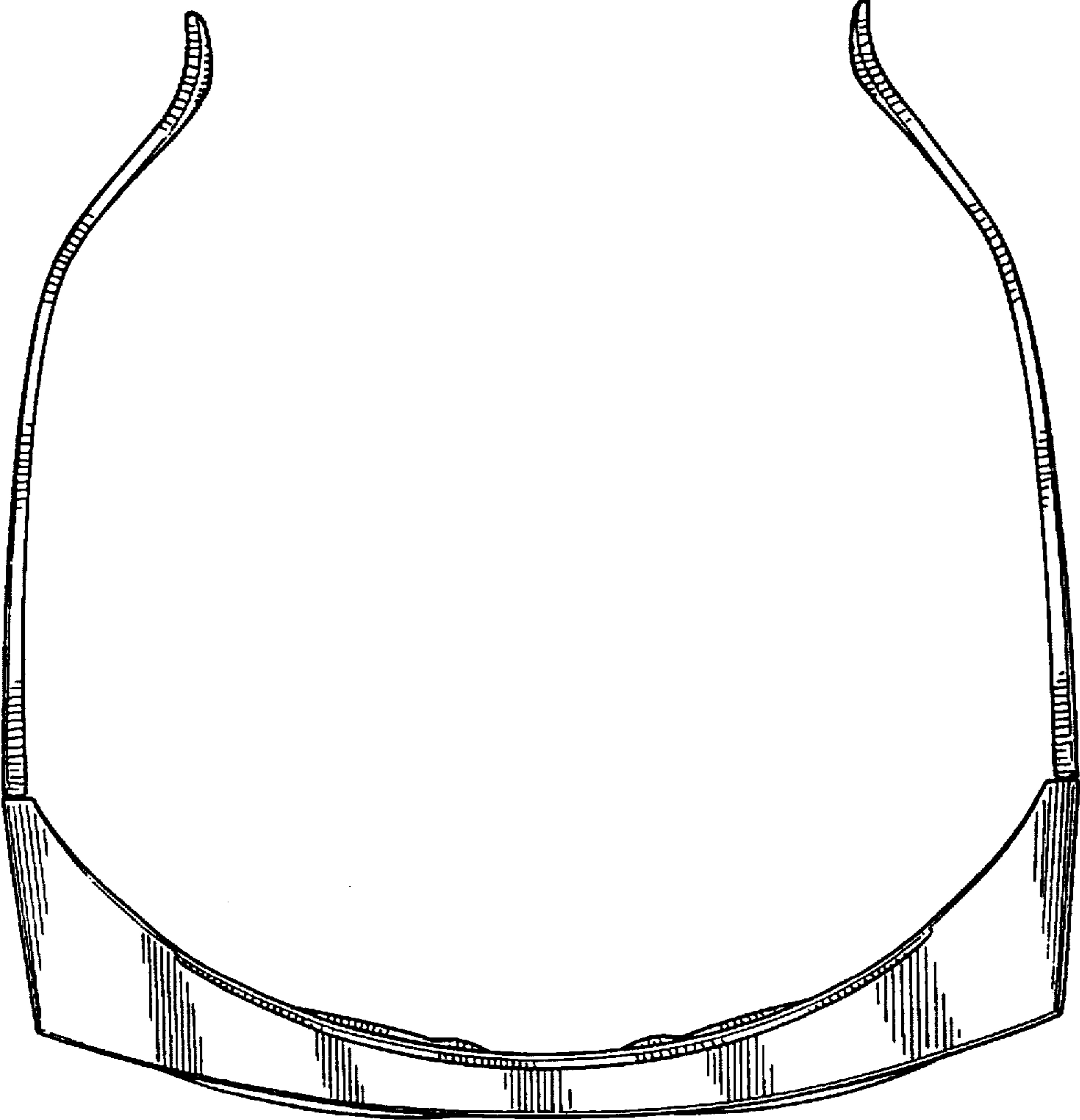

FIG. 3

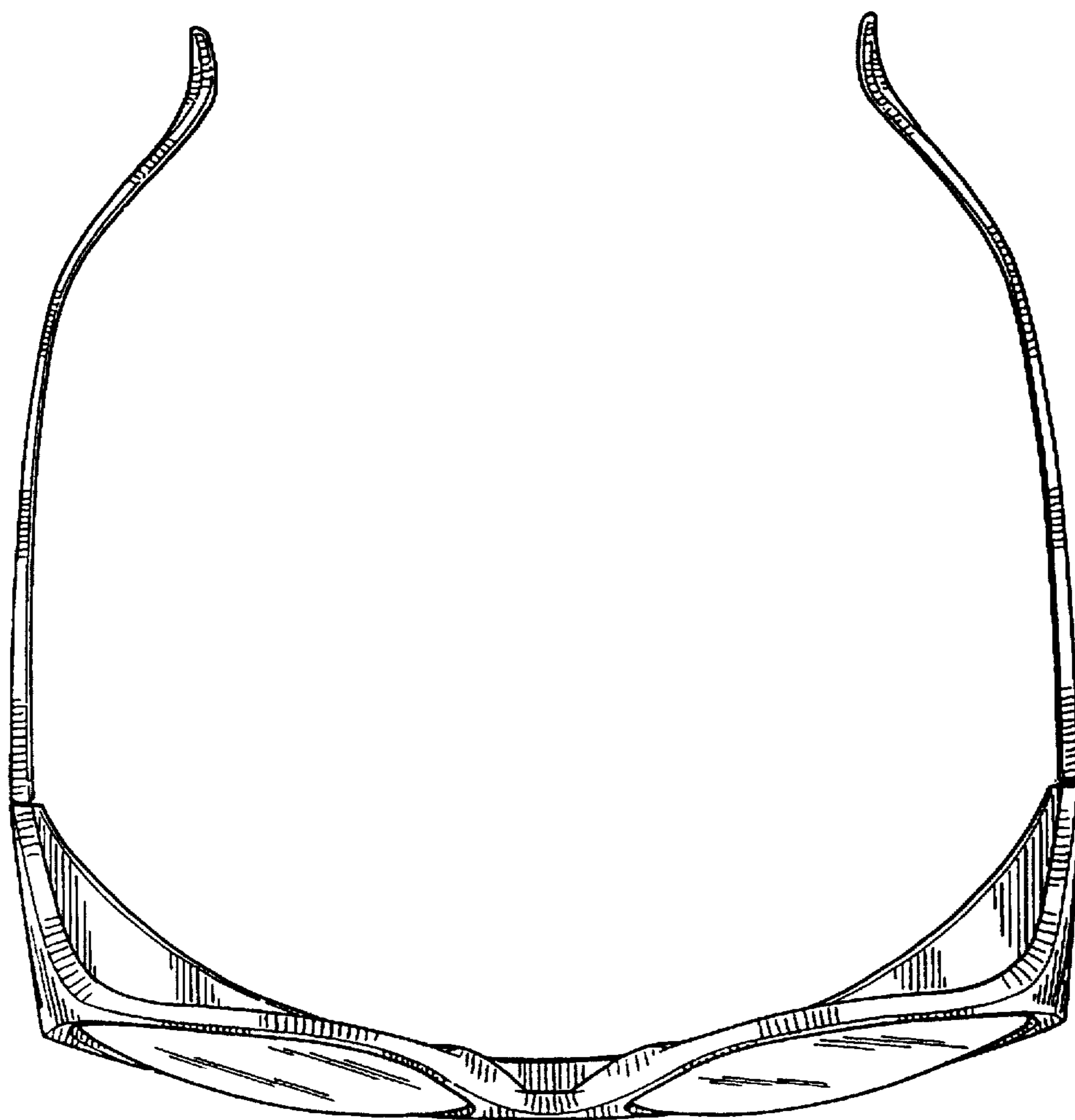

FIG. 4

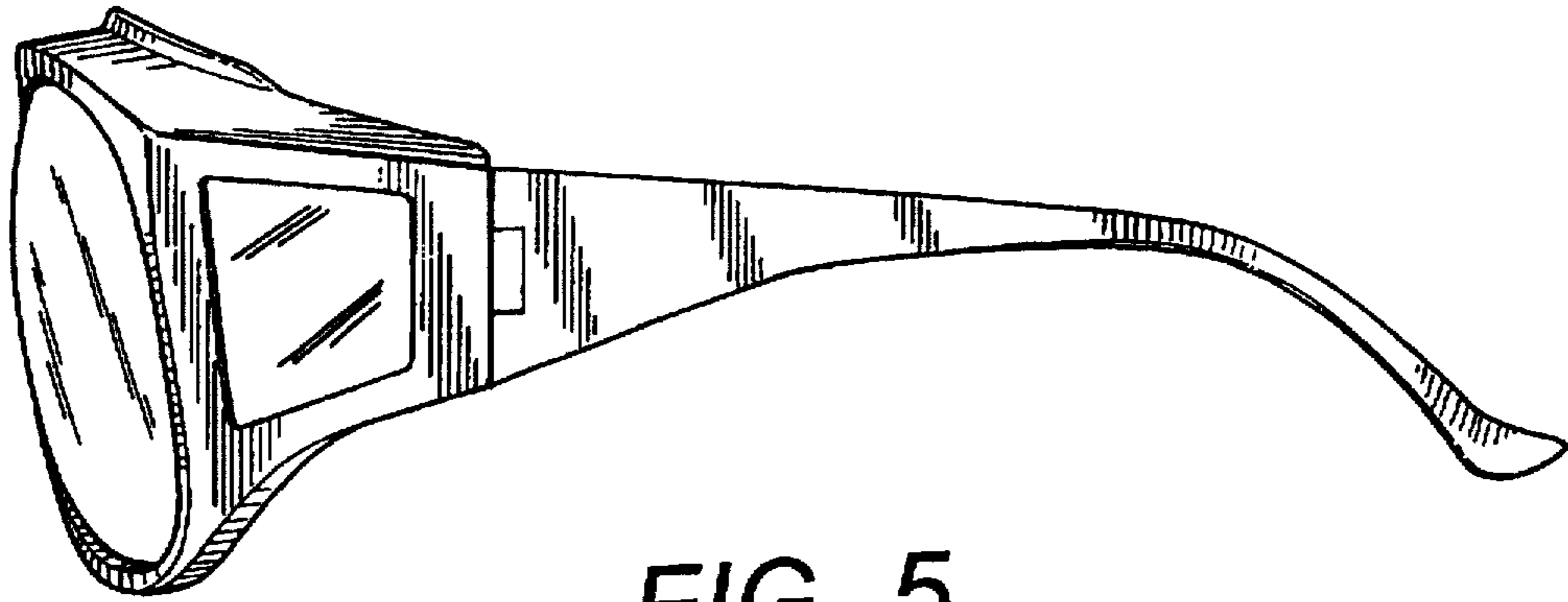

FIG. 5

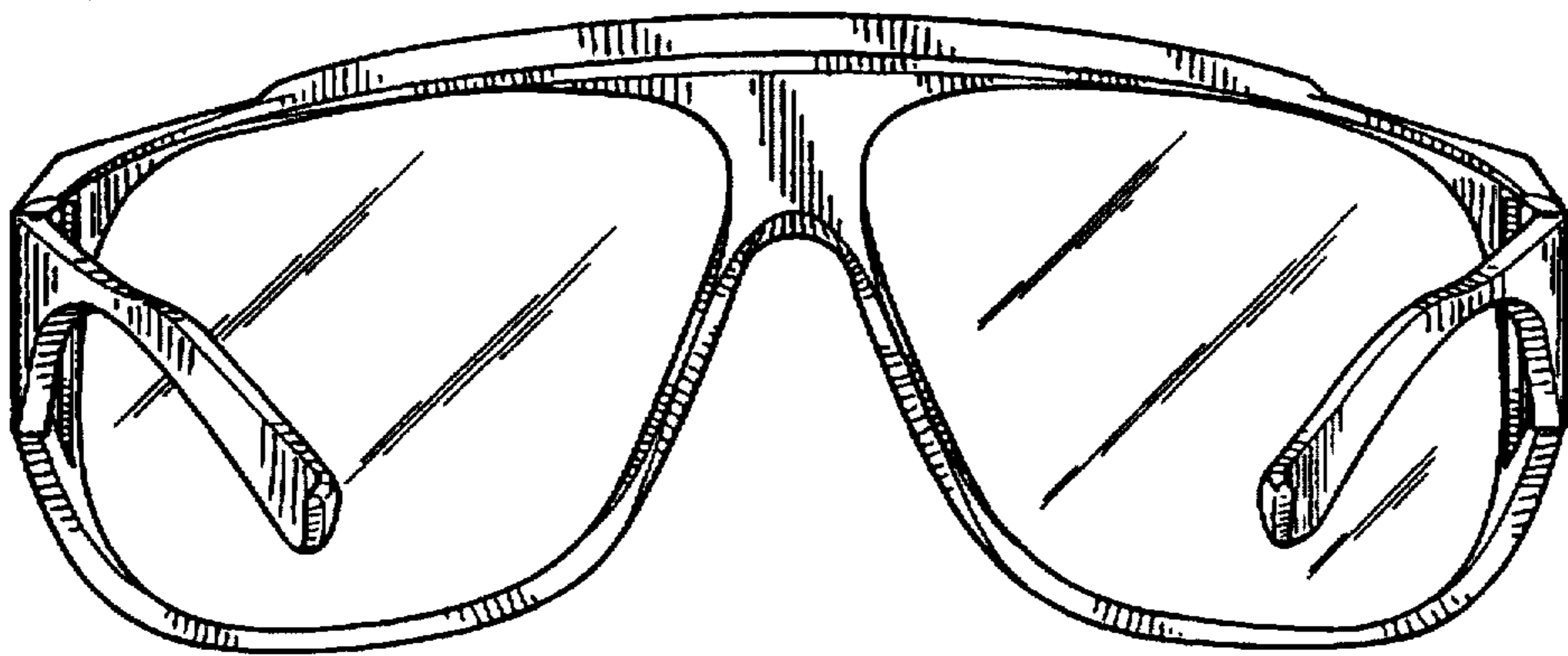

FIG. 6

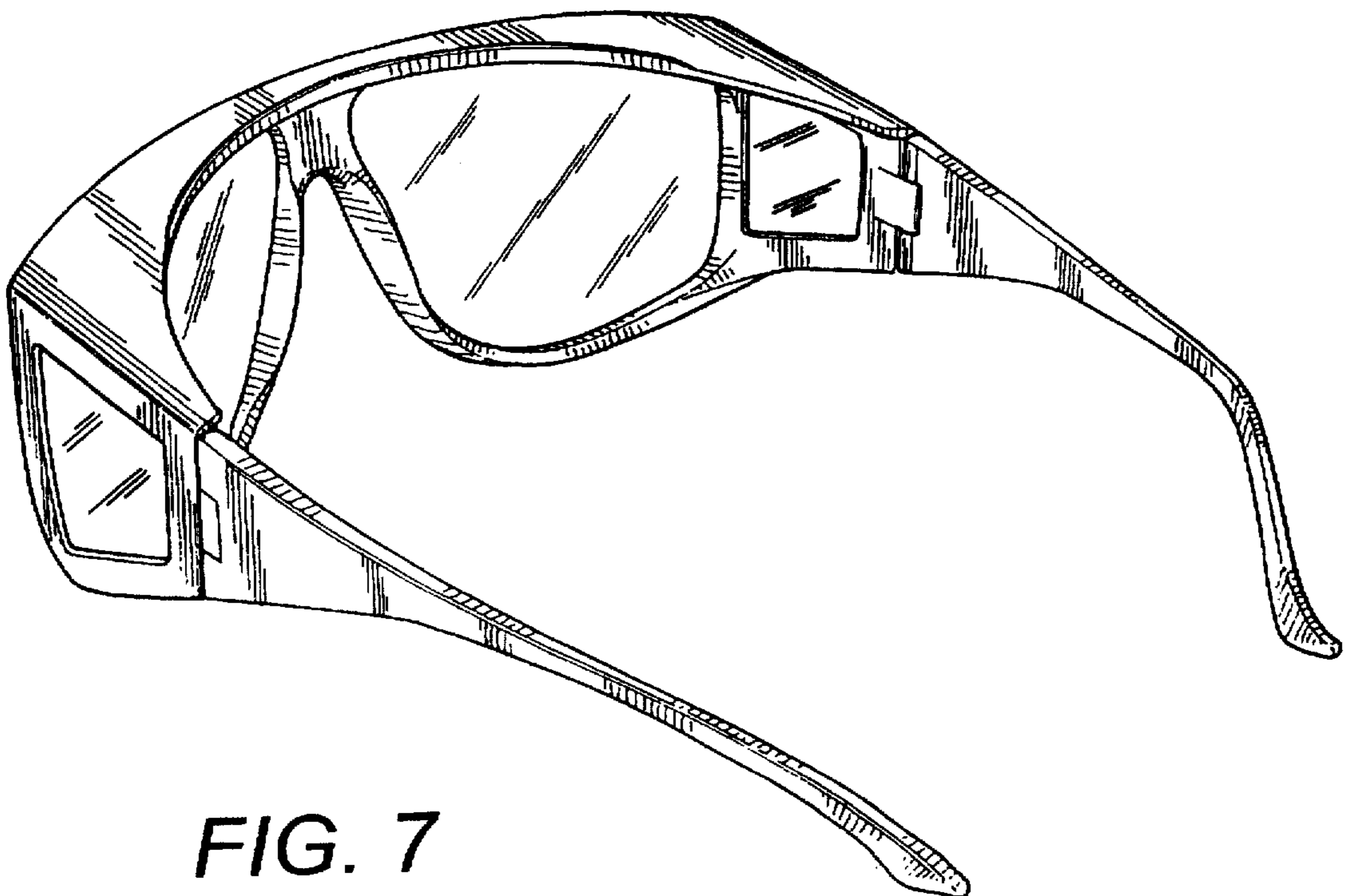

FIG. 7

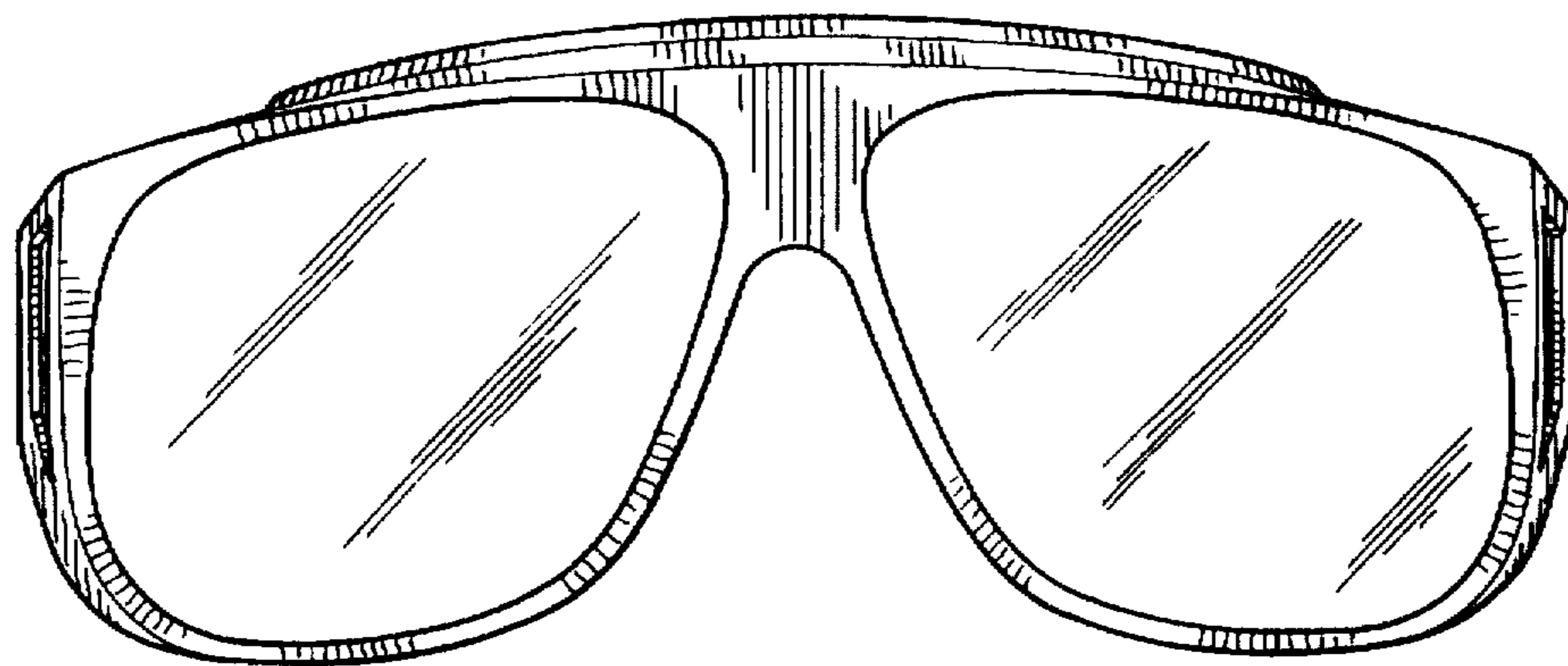

FIG. 8

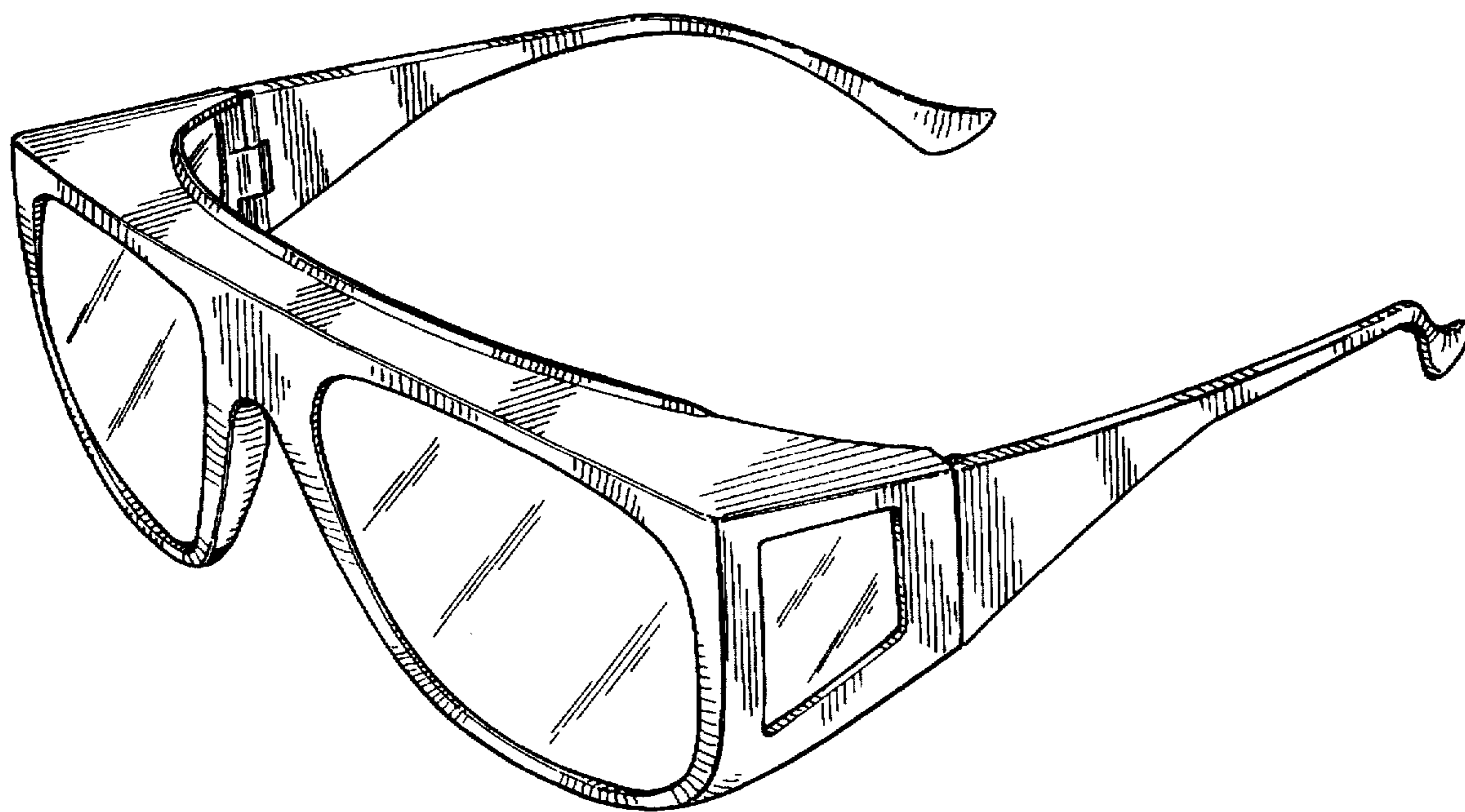

FIG. 9

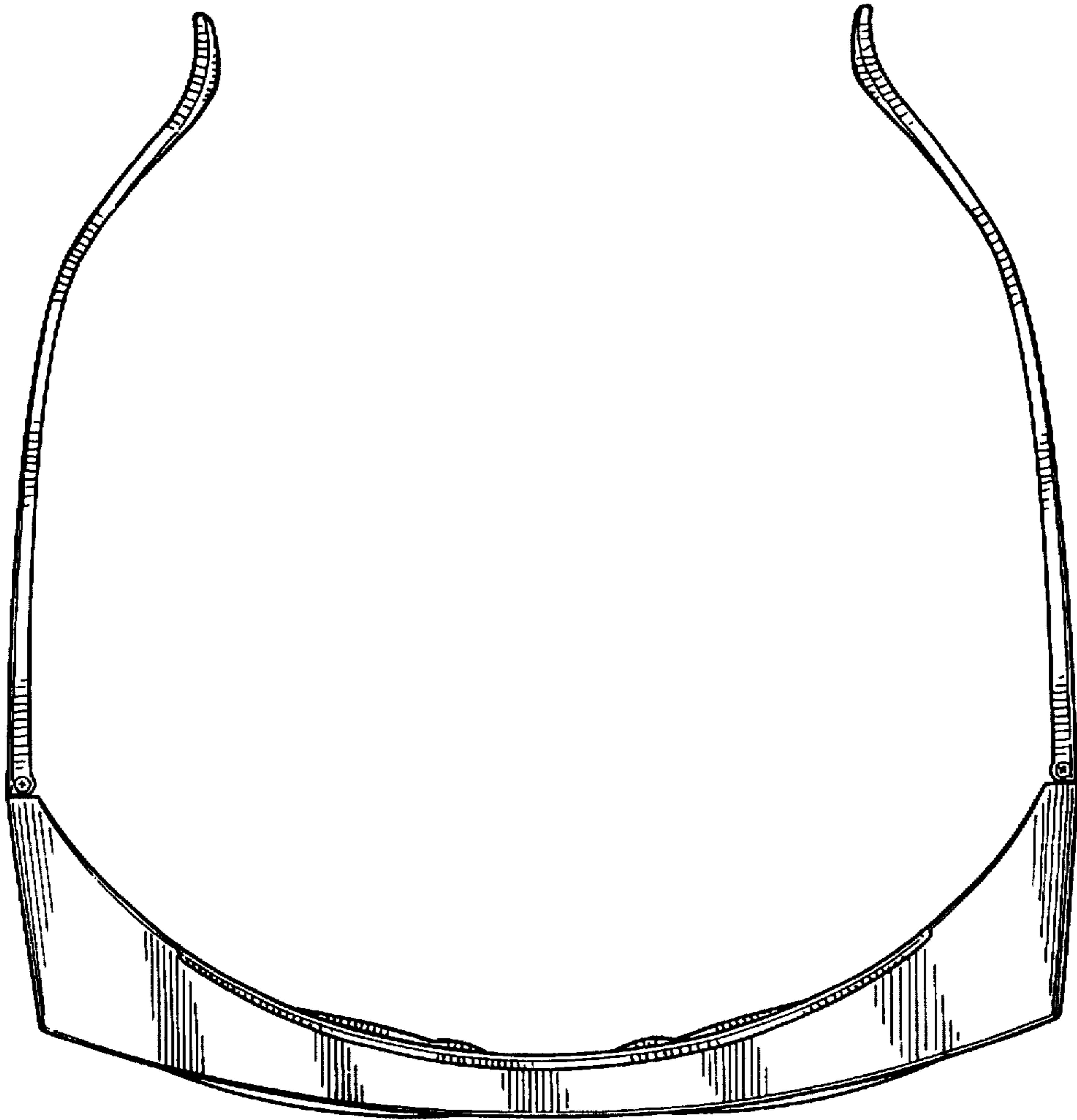

FIG. 10

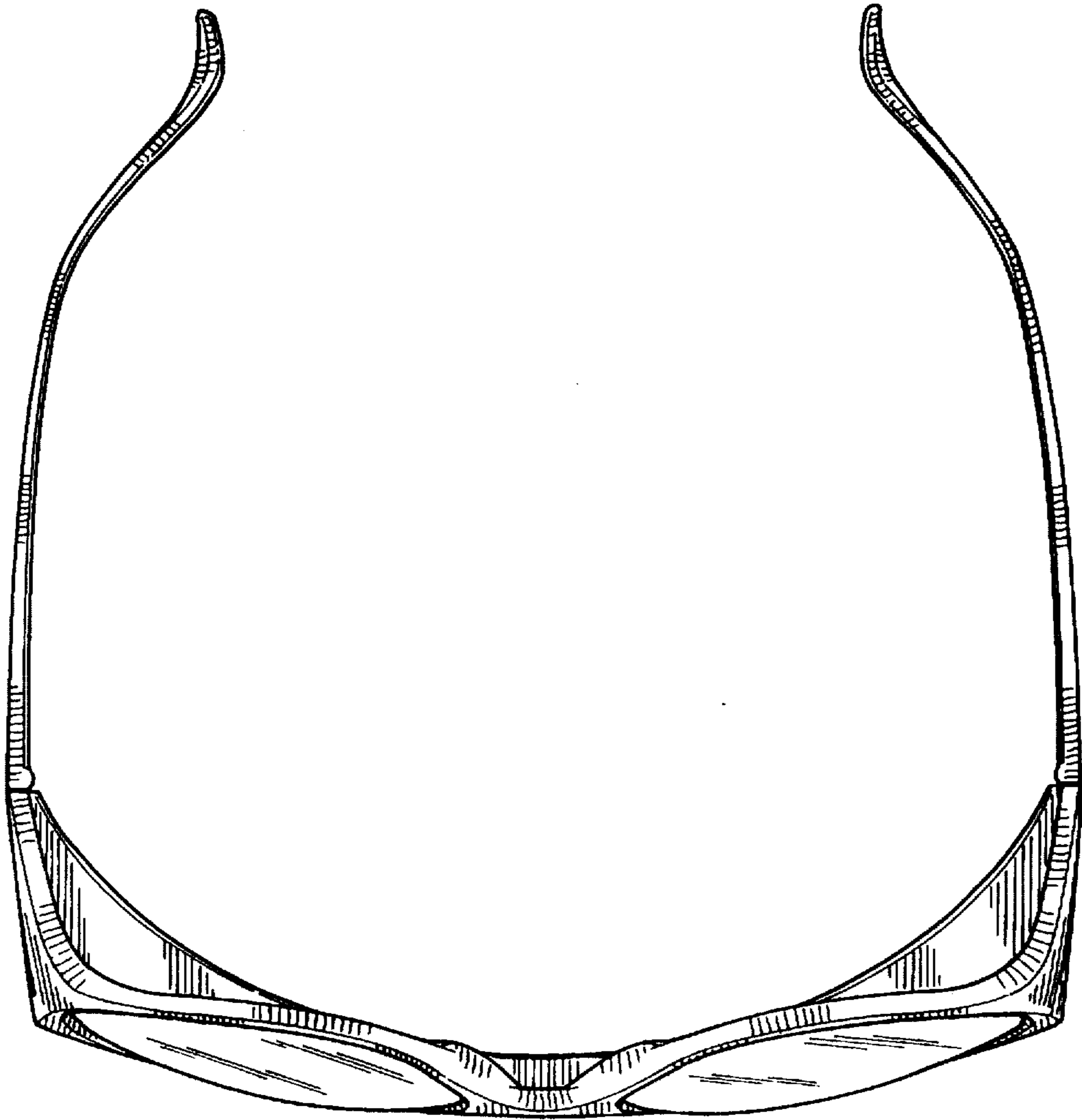

FIG. 11

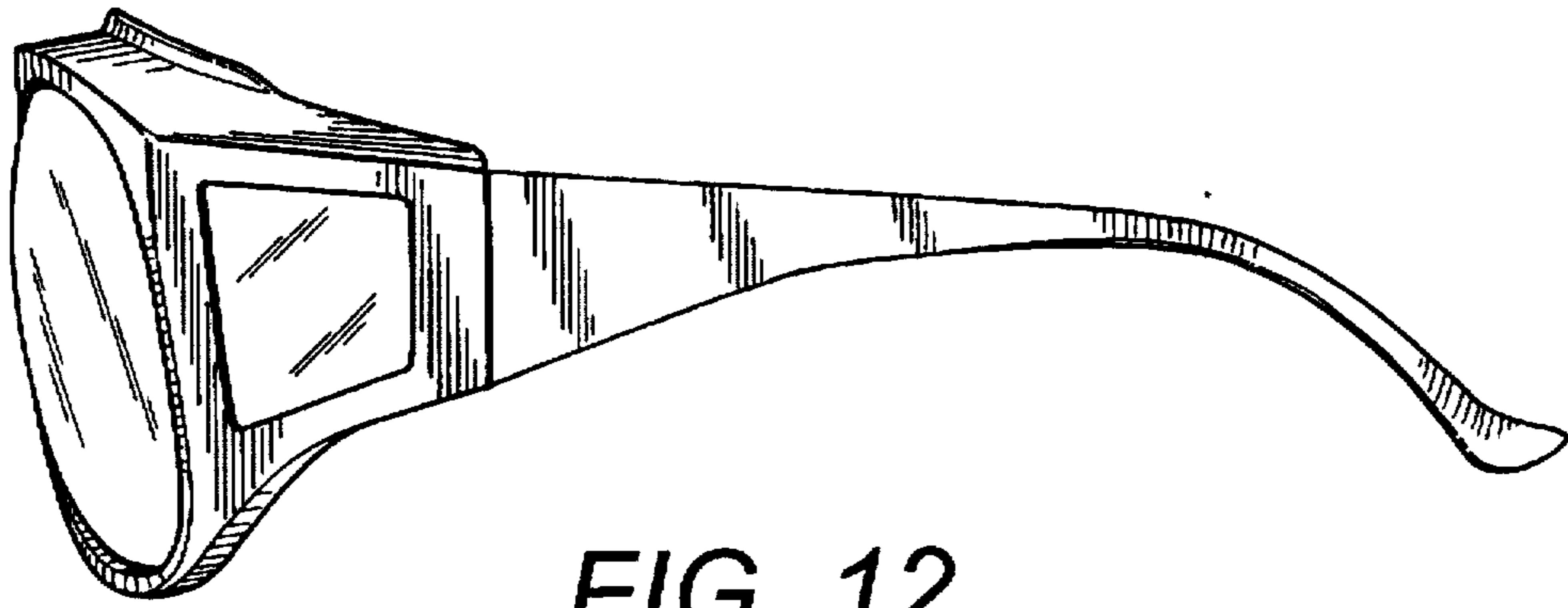

FIG. 12

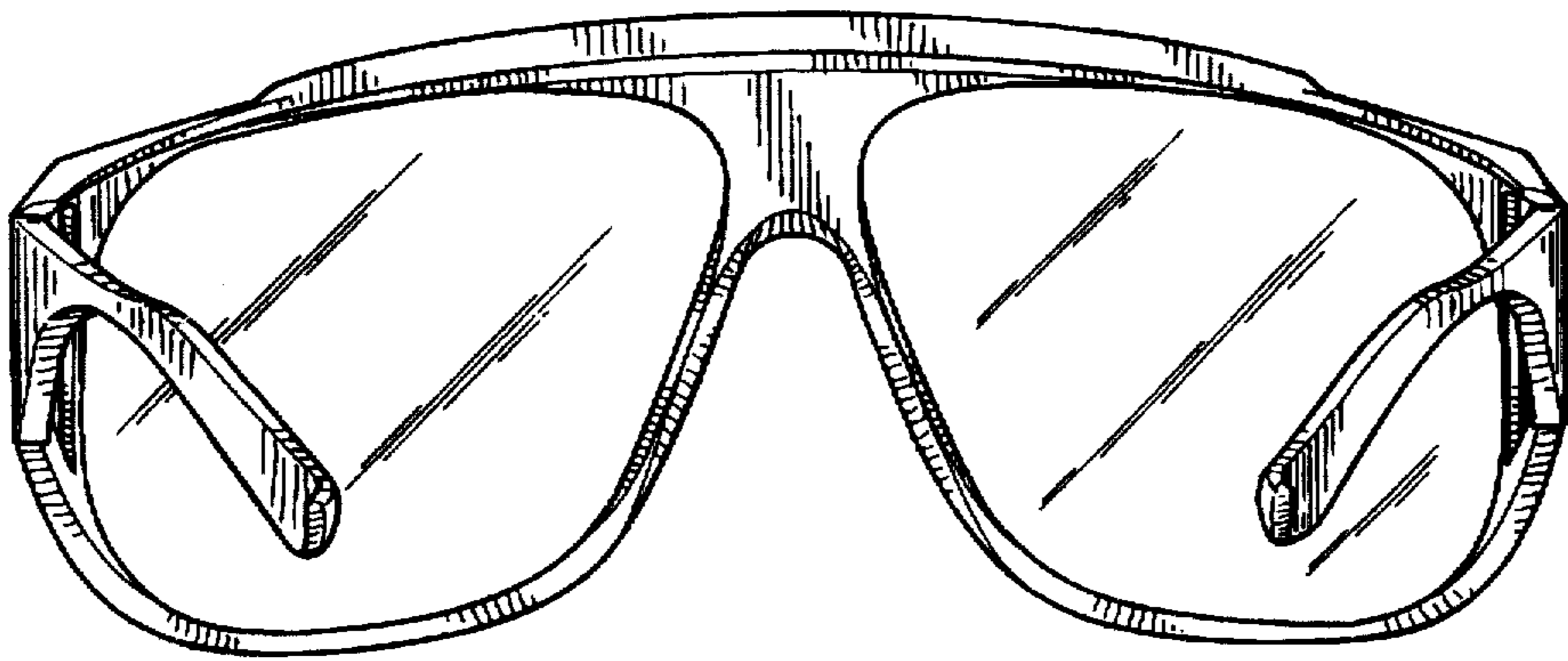

FIG. 13

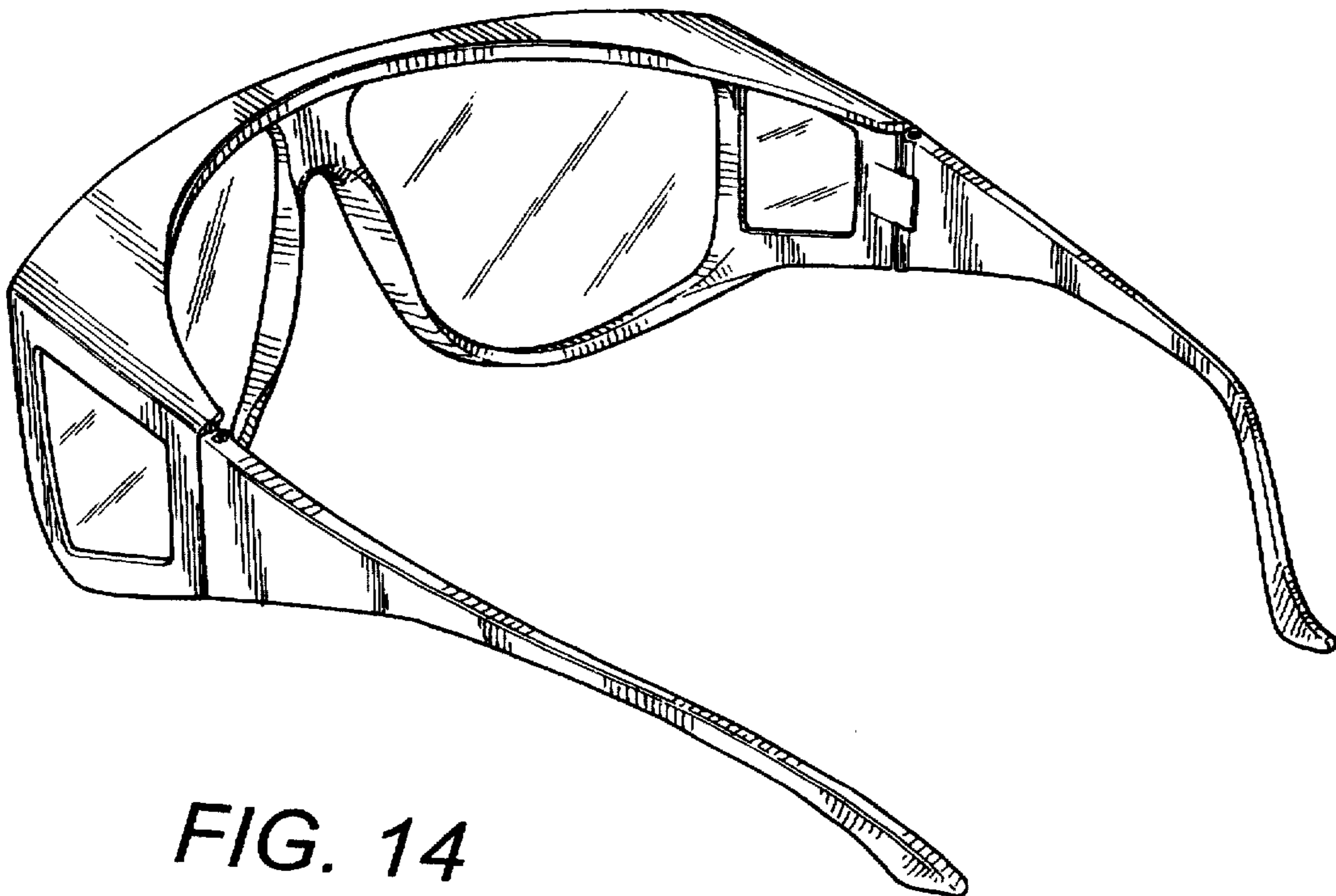

FIG. 14