



US00D396439S

United States Patent [19]

Turnquest

[11] Patent Number: **Des. 396,439**

[45] Date of Patent: ****Jul. 28, 1998**

[54] AUTO LICENSE PLATE LOCK BOX SYSTEM

[76] Inventor: **Anthony Turnquest**, 7471 SW. 10Ct
202D, North Lauderdale, Fla. 33068

[**] Term: **14 Years**

[21] Appl. No.: **66,551**

[22] Filed: **Feb. 14, 1997**

[51] LOC (6) Cl. **12-16**

[52] U.S. Cl. **D12/193**

[58] Field of Search D12/103; D6/300,
D6/303, 310, 311, 313; D11/99, 133; D20/35,
13; 40/200-203, 209, 210

[56] References Cited

U.S. PATENT DOCUMENTS

D. 308,849	6/1990	Short et al.	D12/193
3,685,188	8/1972	Syversen	40/201
5,012,602	5/1991	Storey	40/202
5,404,664	4/1995	Brooks et al.	40/202
5,659,986	8/1997	Simmons	40/202

Primary Examiner—Jeffrey Asch
Assistant Examiner—Stacia Sinuik

[57] CLAIM

The ornamental design for a auto license plate lock box system, as shown and described.

DESCRIPTION

FIG. 1 is a front plan view of the auto license plate lock box system of the present invention;
 FIG. 2 is a rear plan view of the auto license plate lock box system of FIG. 1;
 FIG. 3 is a right side plan view of the auto license plate lock box system of FIG. 1;
 FIG. 4 is a left side plan view of the auto license plate lock box system of FIG. 1;
 FIG. 5 is a top plan view of the auto license plate lock box system of FIG. 1;
 FIG. 6 is a bottom plan view of the auto license plate lock box system of FIG. 1; and
 FIG. 7 is an exploded top, front, right side perspective view of the auto license plate lock box system of FIG. 1.

1 Claim, 3 Drawing Sheets

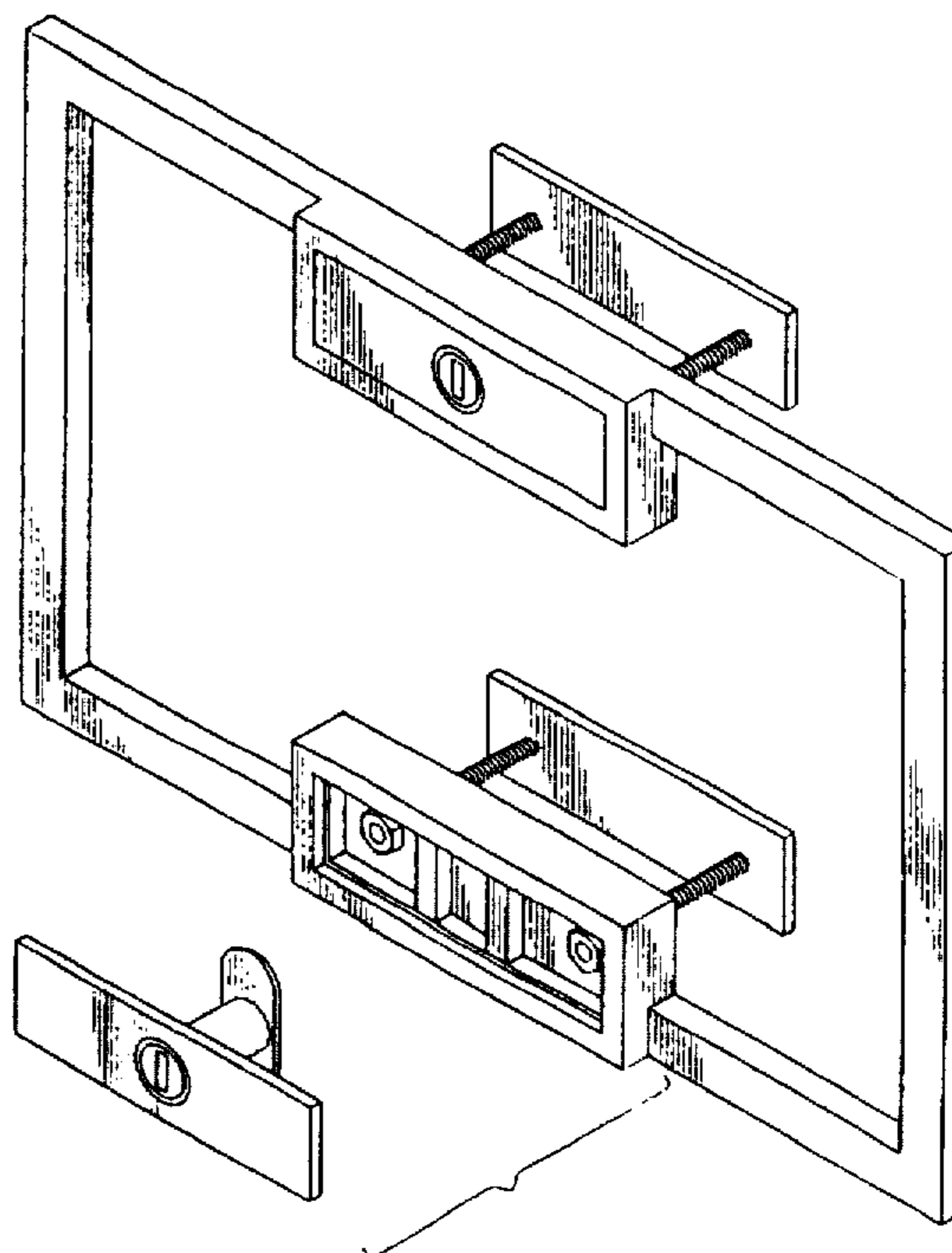
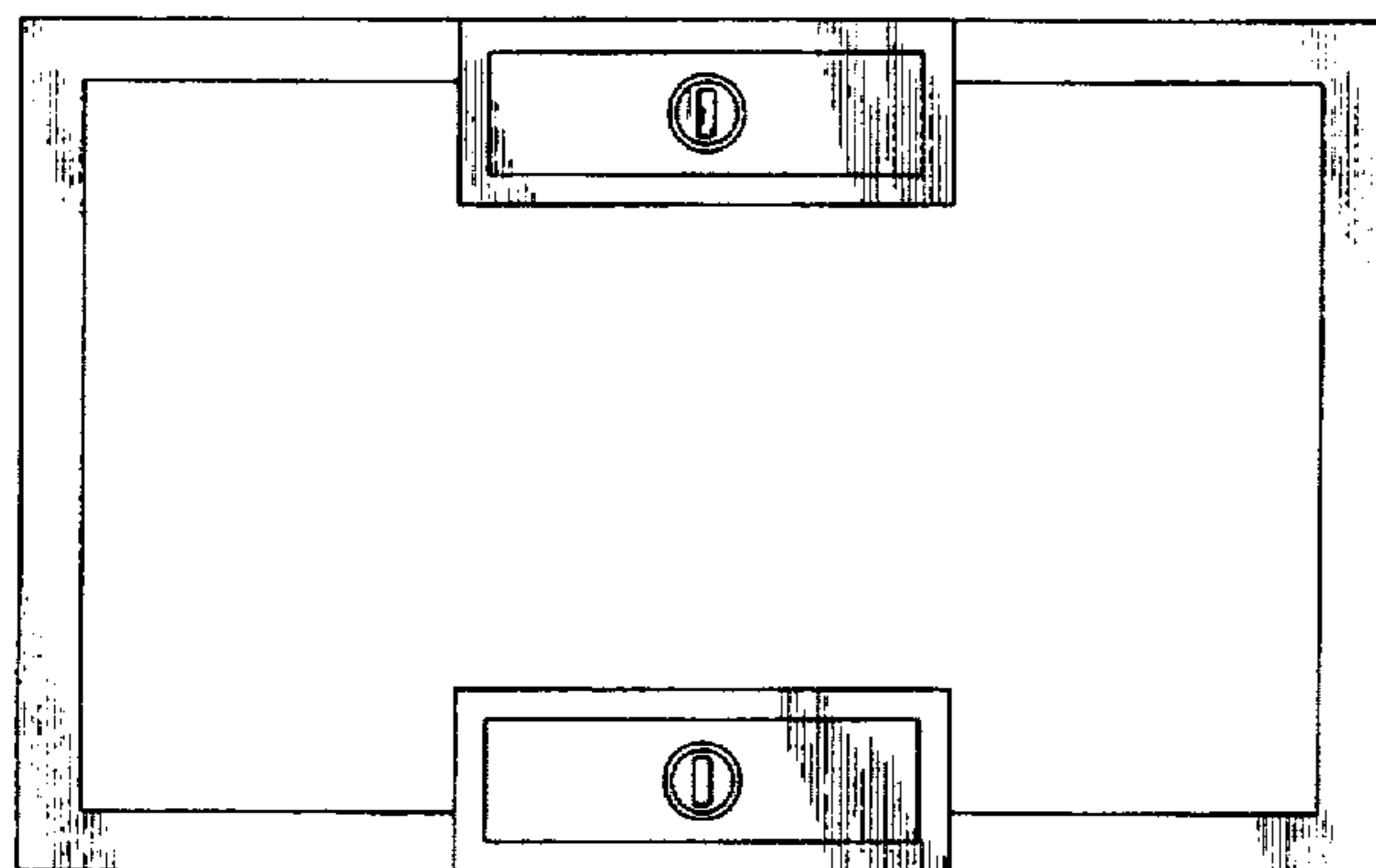

FIG. 1

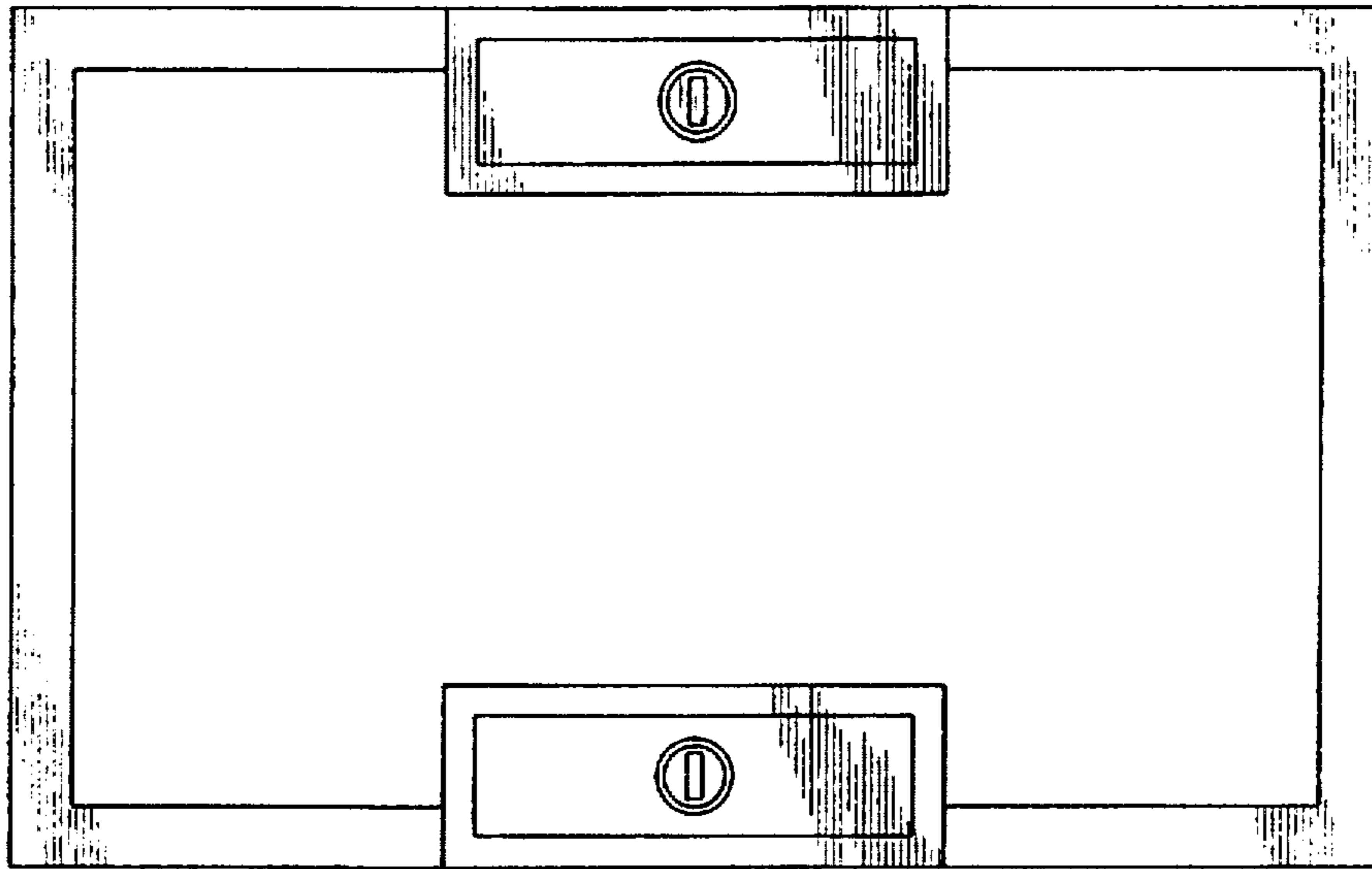

FIG. 2

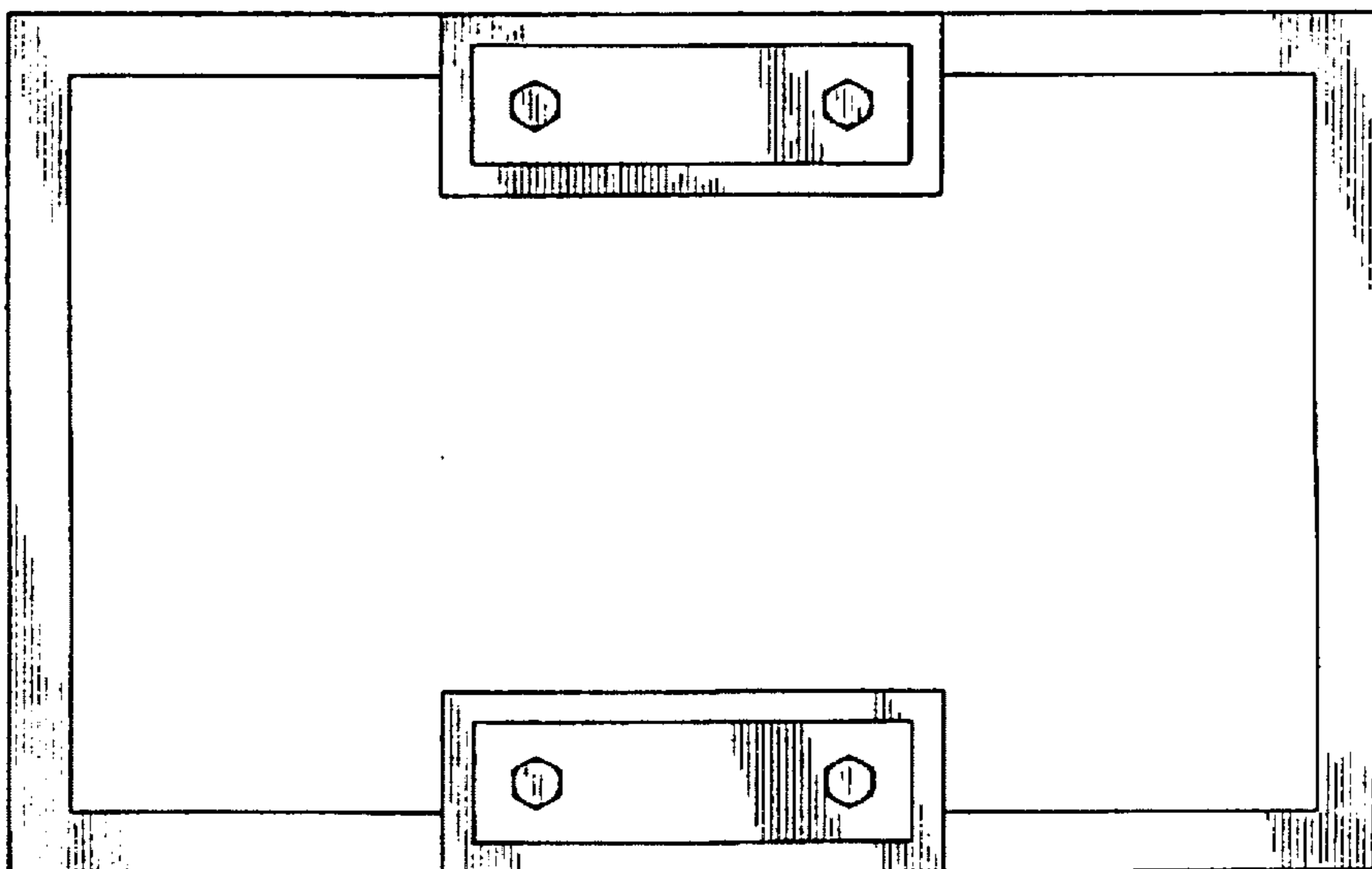

FIG. 3

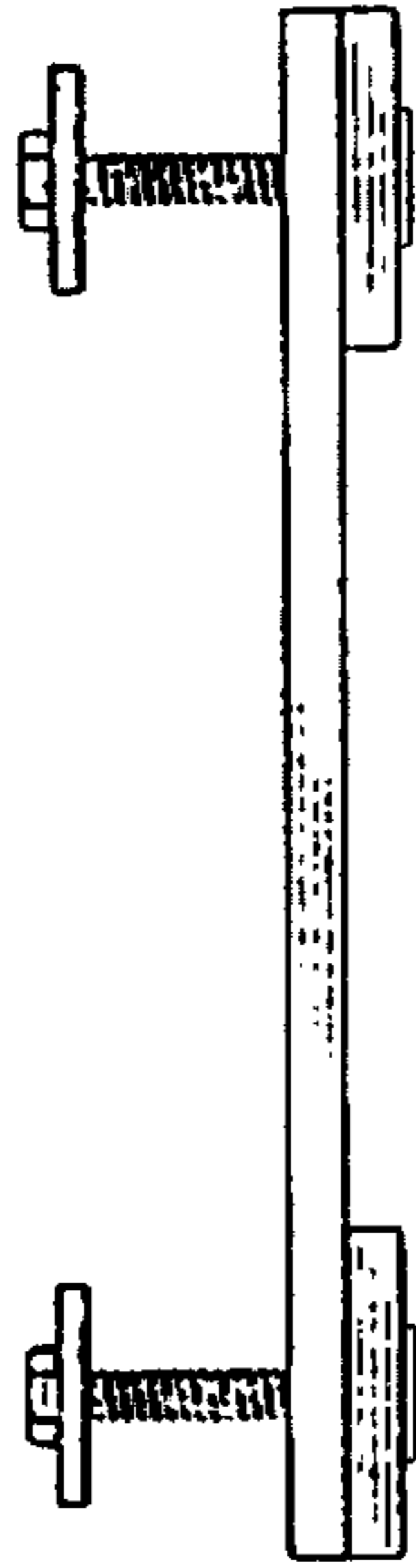

FIG. 4

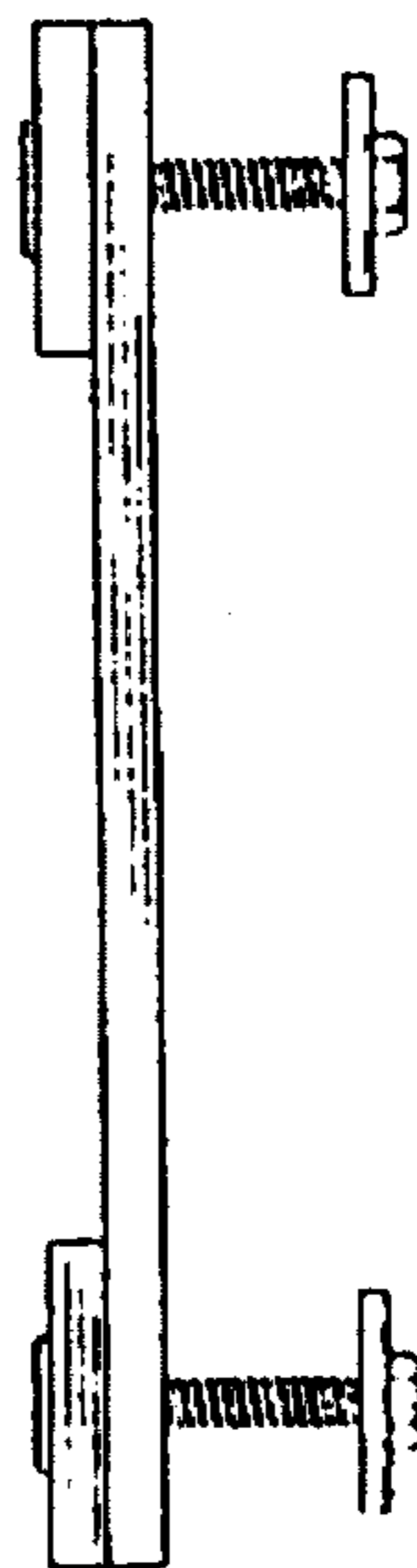

FIG. 5

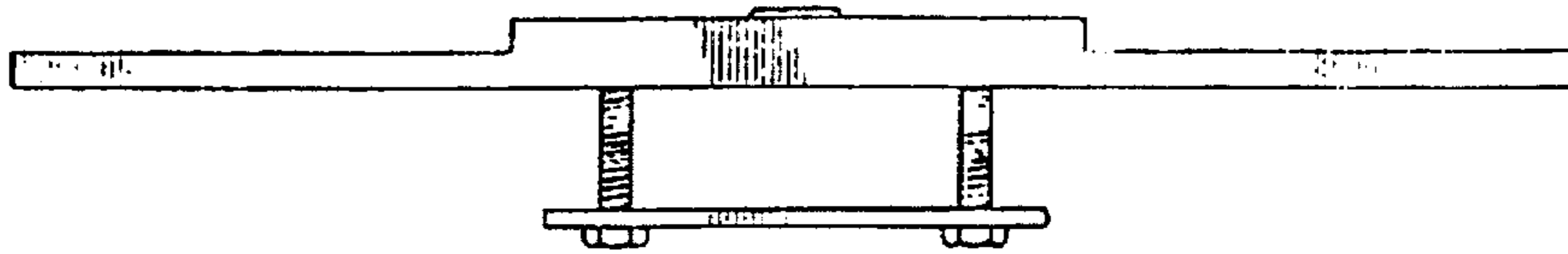

FIG. 6

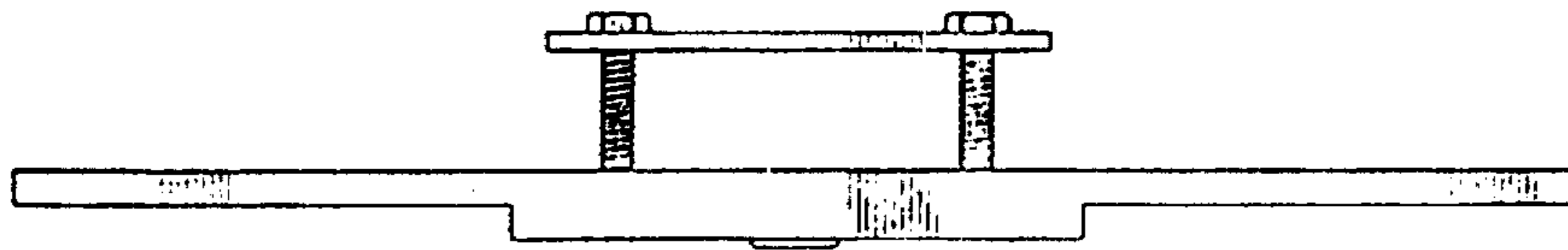

FIG. 7

