



US00D396378S

United States Patent [19] Hensel

[11] Patent Number: **Des. 396,378**
[45] Date of Patent: ****Jul. 28, 1998**

[54] **KETTLE**

[75] Inventor: **Keith James Hensel**, Greenwich, Australia
[73] Assignee: **Sunbeam Corporation Limited**, New South Wales, Australia
[**] Term: **14 Years**

[21] Appl. No.: **74,821**
[22] Filed: **Aug. 11, 1997**

[30] **Foreign Application Priority Data**

Feb. 12, 1997 [AU] Australia 407/1997

[51] **LOC (6) Cl.** **07-01**
[52] **U.S. Cl.** **D7/319; D7/317**
[58] **Field of Search** **D7/300, 302, 303, D7/312, 316, 317, 318, 319, 321, 322, 598, 600, 605, 608; 222/465.1, 475.1**

[56] **References Cited**

U.S. PATENT DOCUMENTS

D. 285,160	8/1986	Osit	D7/317
D. 287,807	1/1987	Wilson	D7/319 X
D. 307,857	5/1990	Grome et al.	D7/317
D. 335,238	5/1993	Correa et al.	D7/318 X
D. 335,239	5/1993	Crunten et al.	D7/318 X
D. 345,669	4/1994	Piret	D7/319
D. 345,670	4/1994	Piret	D7/318 X
D. 362,151	9/1995	Wilson et al.	D7/319
D. 362,582	9/1995	Wilson et al.	D7/319
D. 367,201	2/1996	Joergensen	D7/317 X
D. 367,394	2/1996	Wai	D7/318 X
D. 375,866	11/1996	Wai	D7/319
D. 381,858	8/1997	Richaud	D7/318 X
4,825,759	5/1989	Grome et al.	D7/317 X

OTHER PUBLICATIONS

Tefal's electric kettle, HFD, Nov. 24, 1986, p. 70.
Mellerware International hot water jug, Design 440, Aug. 1985, p. 62.

Primary Examiner—M. N. Pandozzi
Attorney, Agent, or Firm—Frommer Lawrence & Haug LLP; William S. Frommer

[57] **CLAIM**

The ornamental design for "a kettle," as shown.

DESCRIPTION

FIG. 1 is a front perspective view of the first embodiment of "a kettle" showing my new design;
FIG. 2 is a rear perspective view of the first embodiment thereof;
FIGS. 3 & 4 are side elevation views of the first embodiment thereof;
FIG. 5 is a front elevational view of the first embodiment thereof;
FIG. 6 is a rear elevation view of the first embodiment thereof;
FIG. 7 is a top plan view of the first embodiment thereof;
FIG. 8 is a bottom plan view of the first embodiment thereof;
FIG. 9 is a front perspective view of the second embodiment thereof;
FIG. 10 is a rear perspective view of the second embodiment thereof;
FIGS. 11 & 12 are side elevation views of the second embodiment thereof;
FIG. 13 is a front elevation view of the second embodiment thereof;
FIG. 14 is a top plan view of the second embodiment thereof; and,
FIG. 15 is a bottom plan view of the second embodiment thereof.

1 Claim, 15 Drawing Sheets

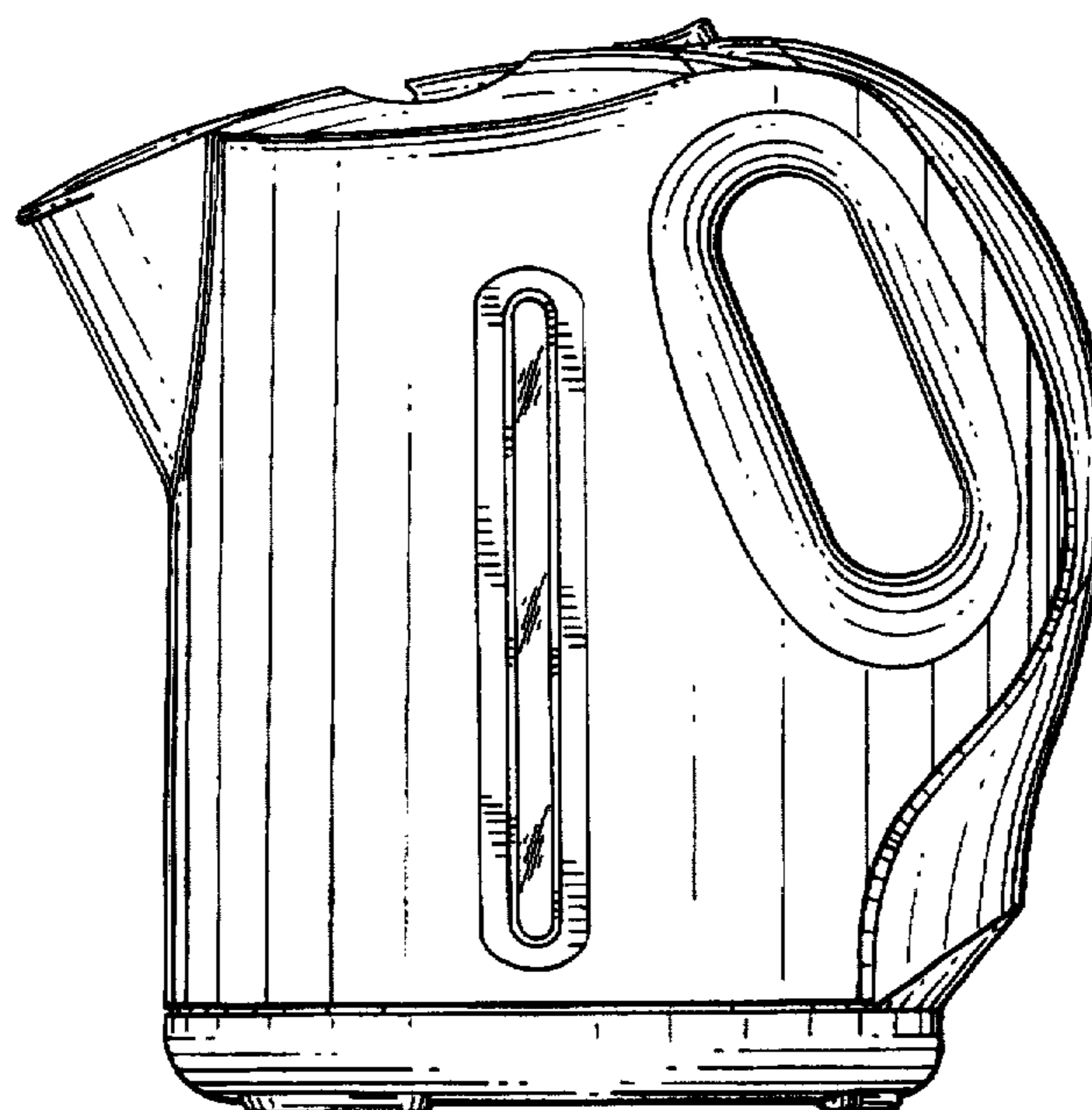

FIG. 1

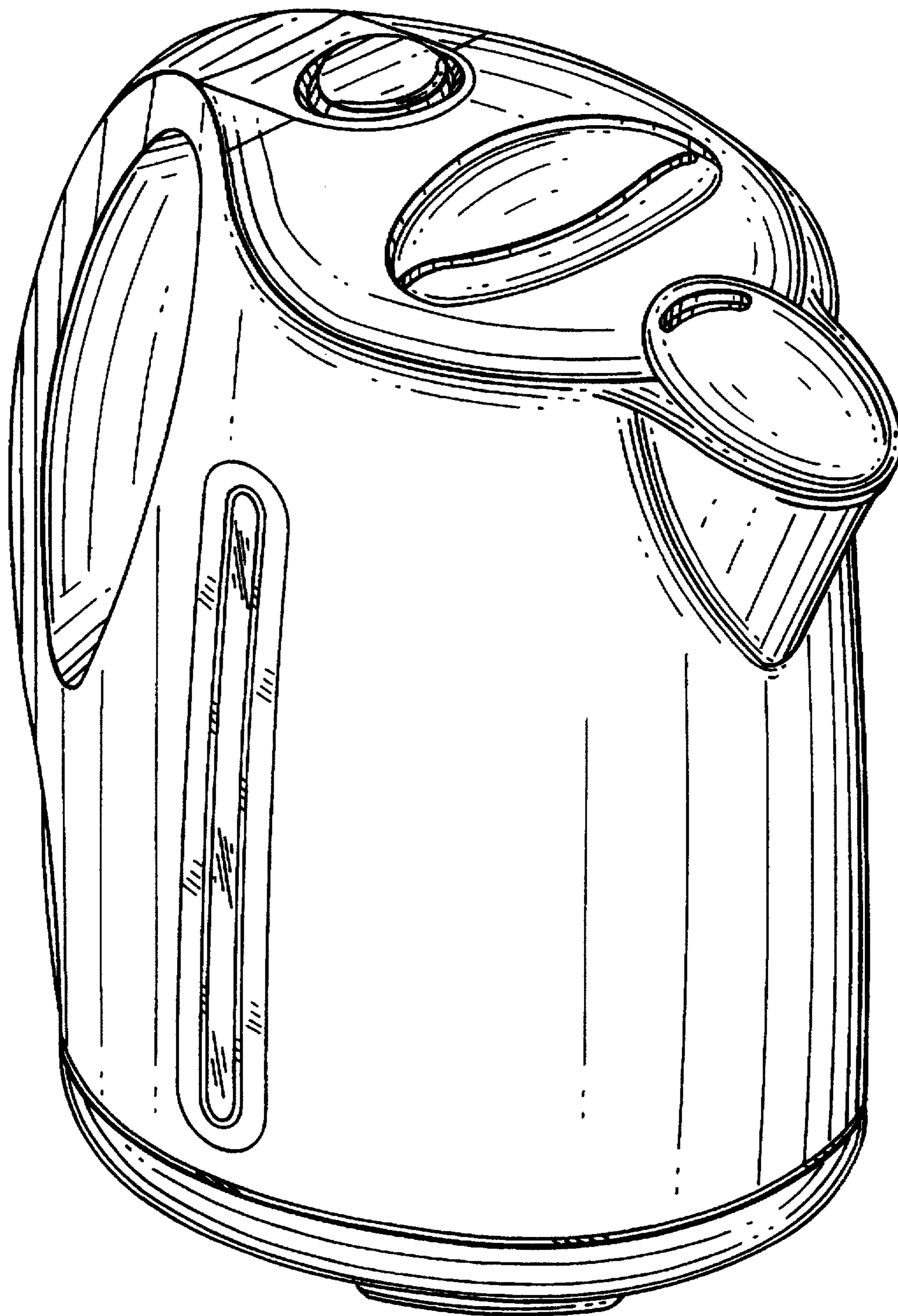

FIG. 2

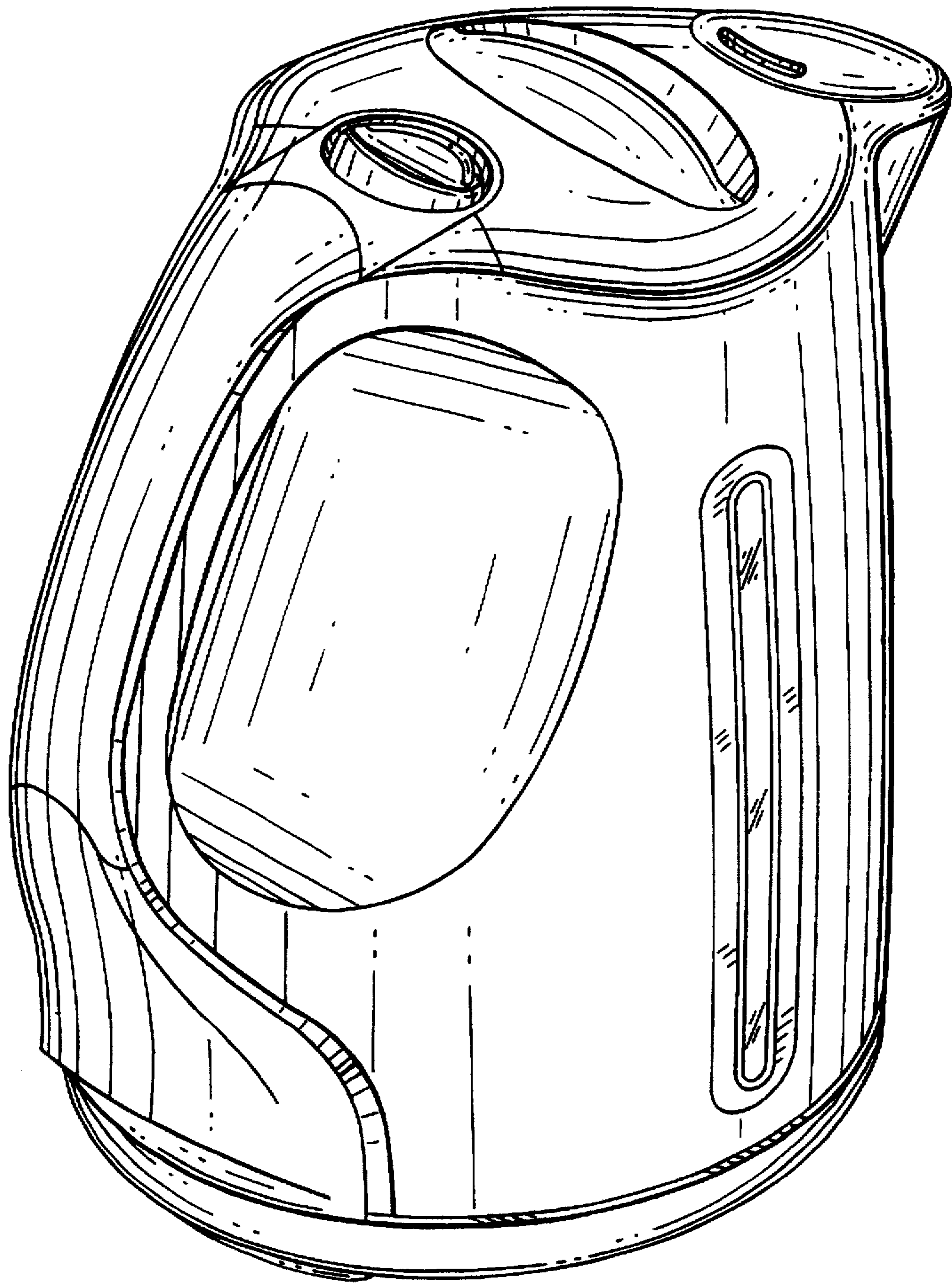

FIG. 3

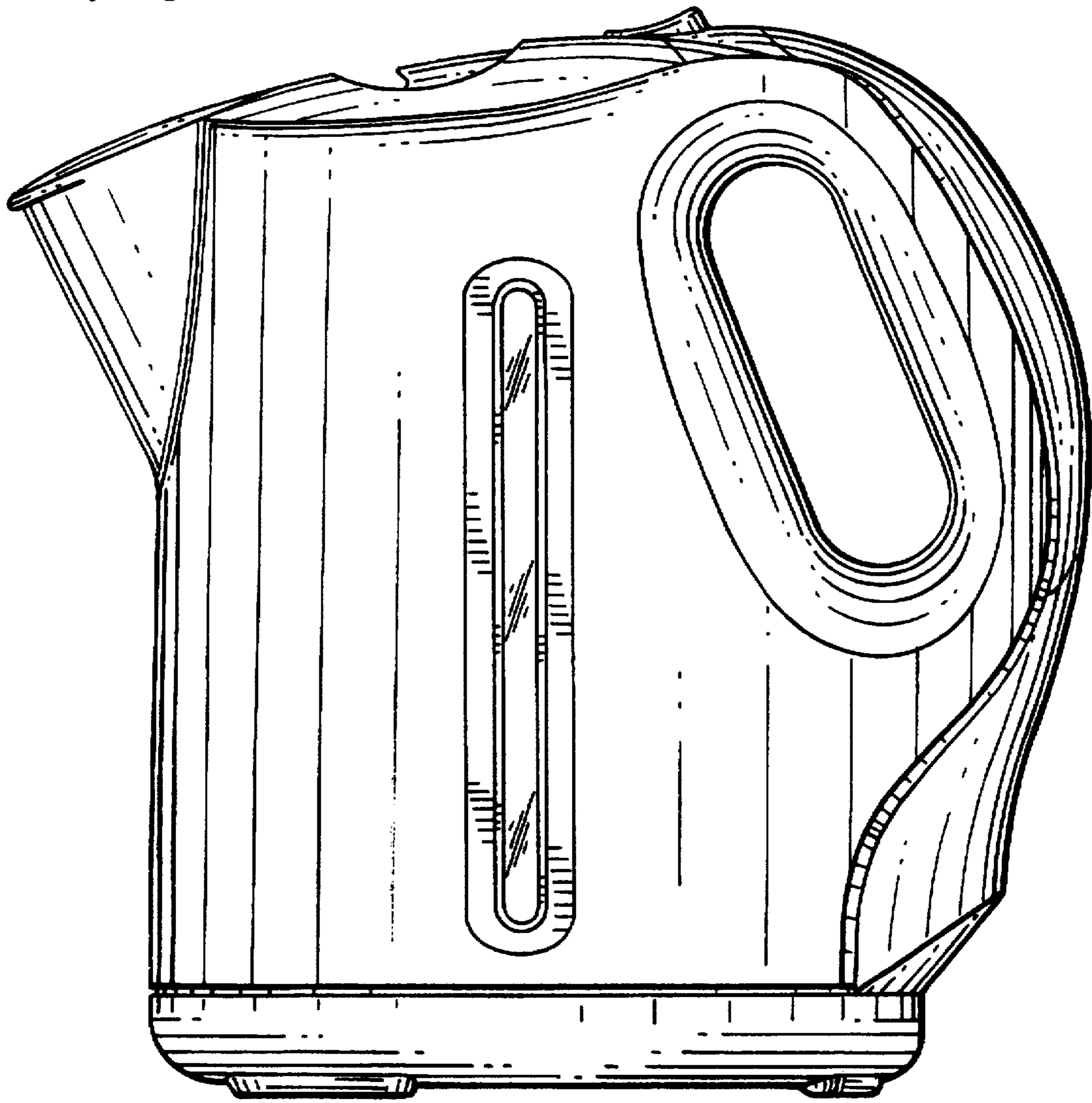

FIG. 4

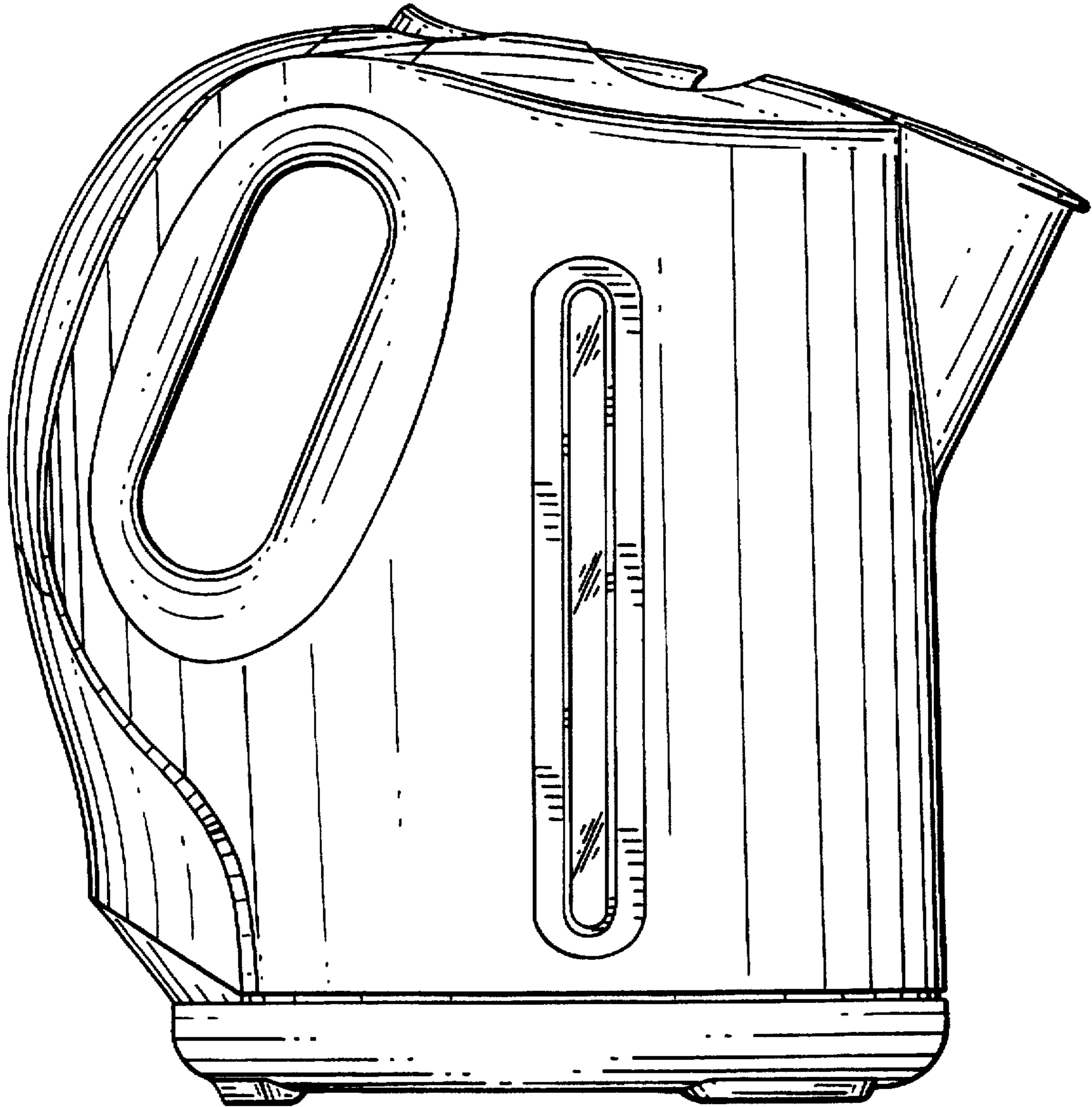

FIG. 5

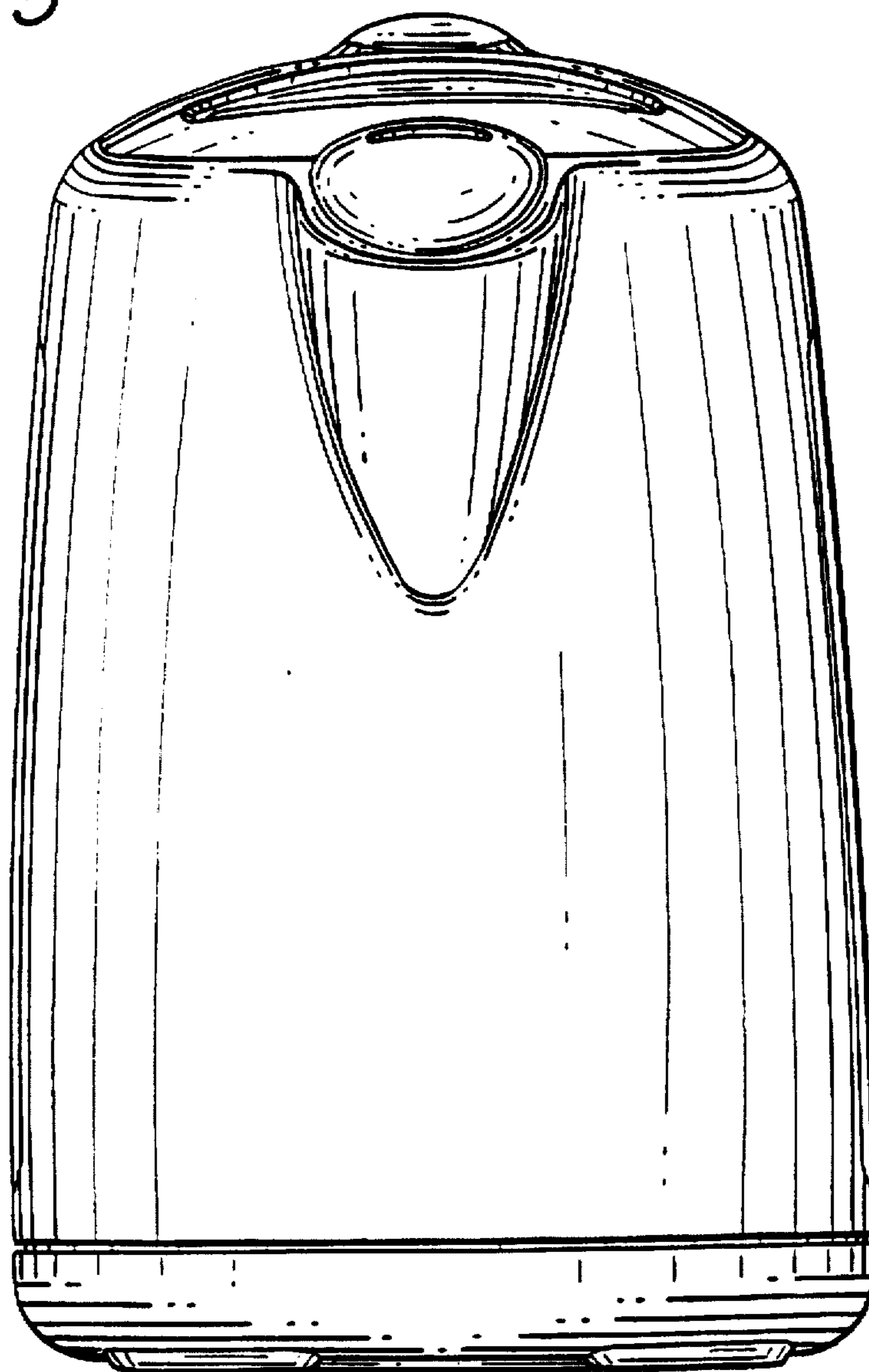
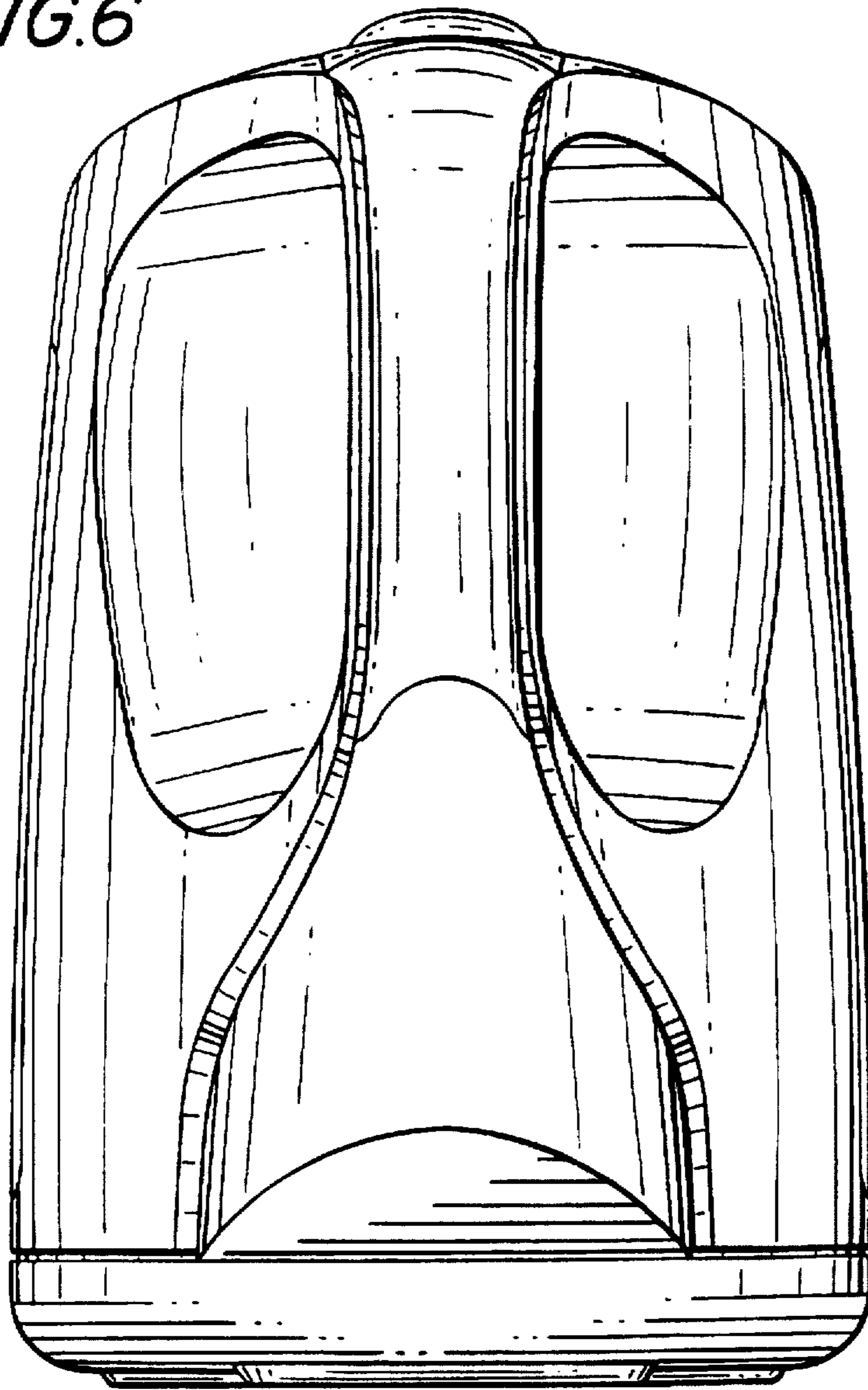

FIG. 6



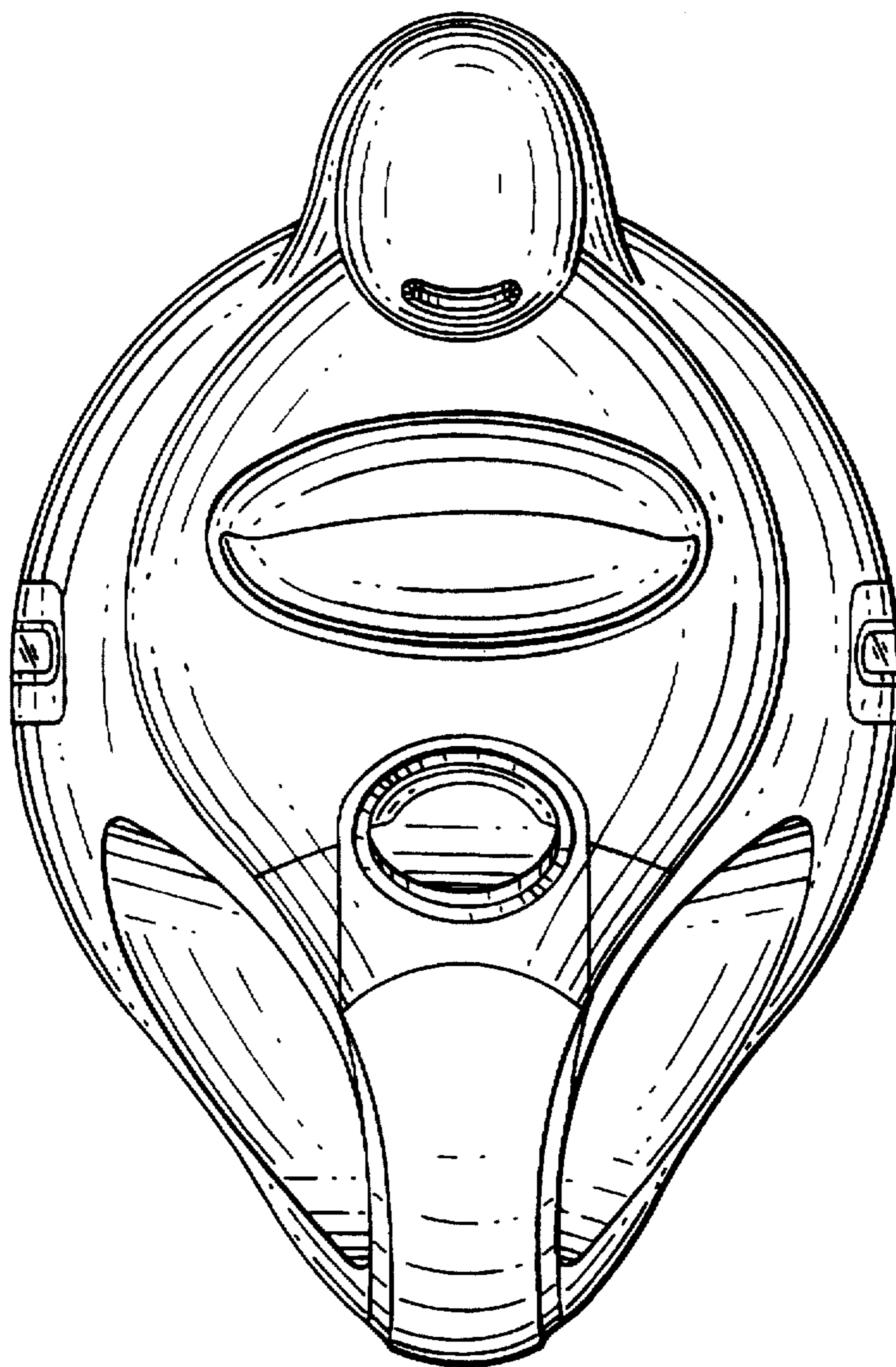

FIG. 7

FIG. 8

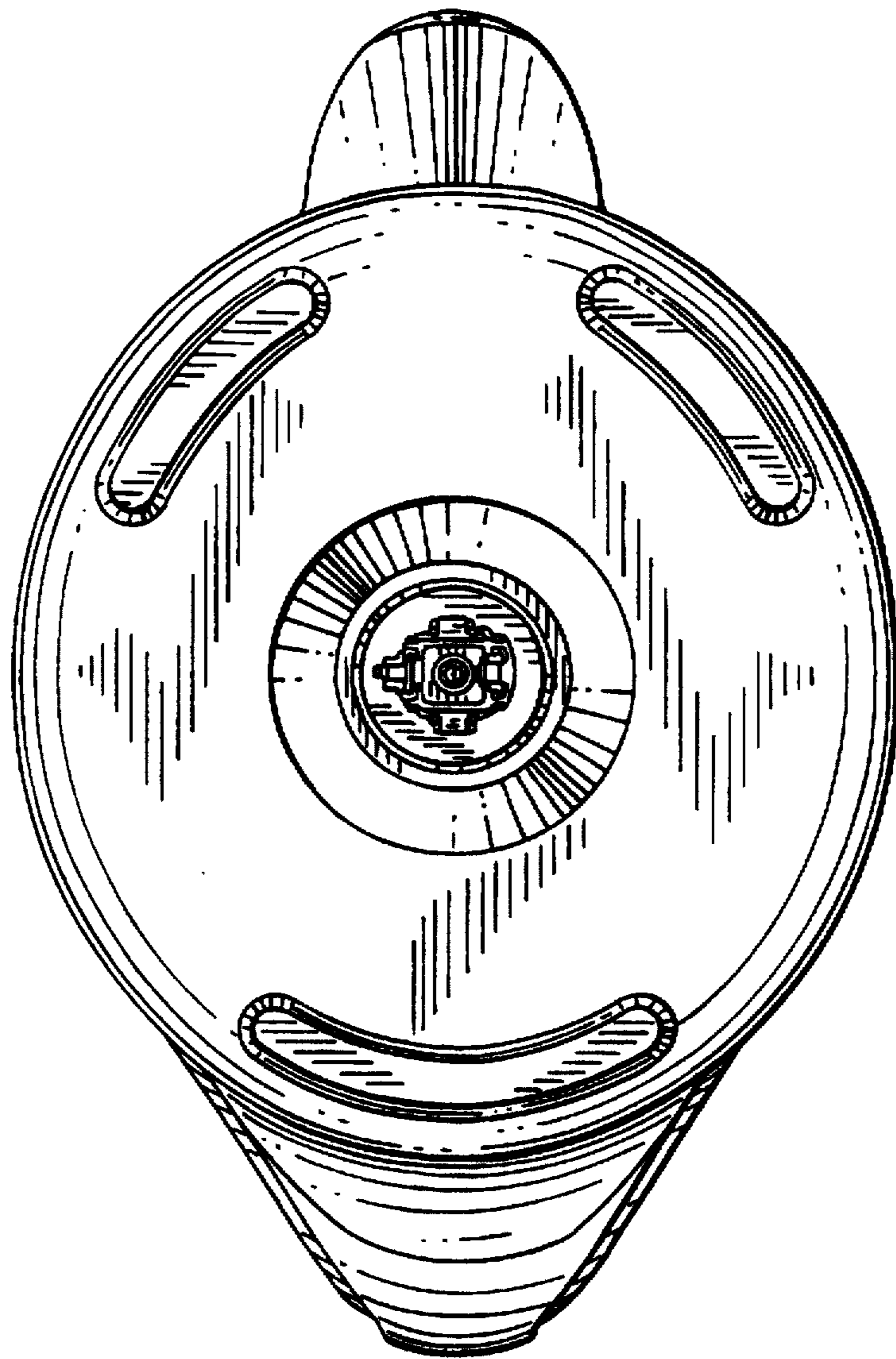

FIG. 9

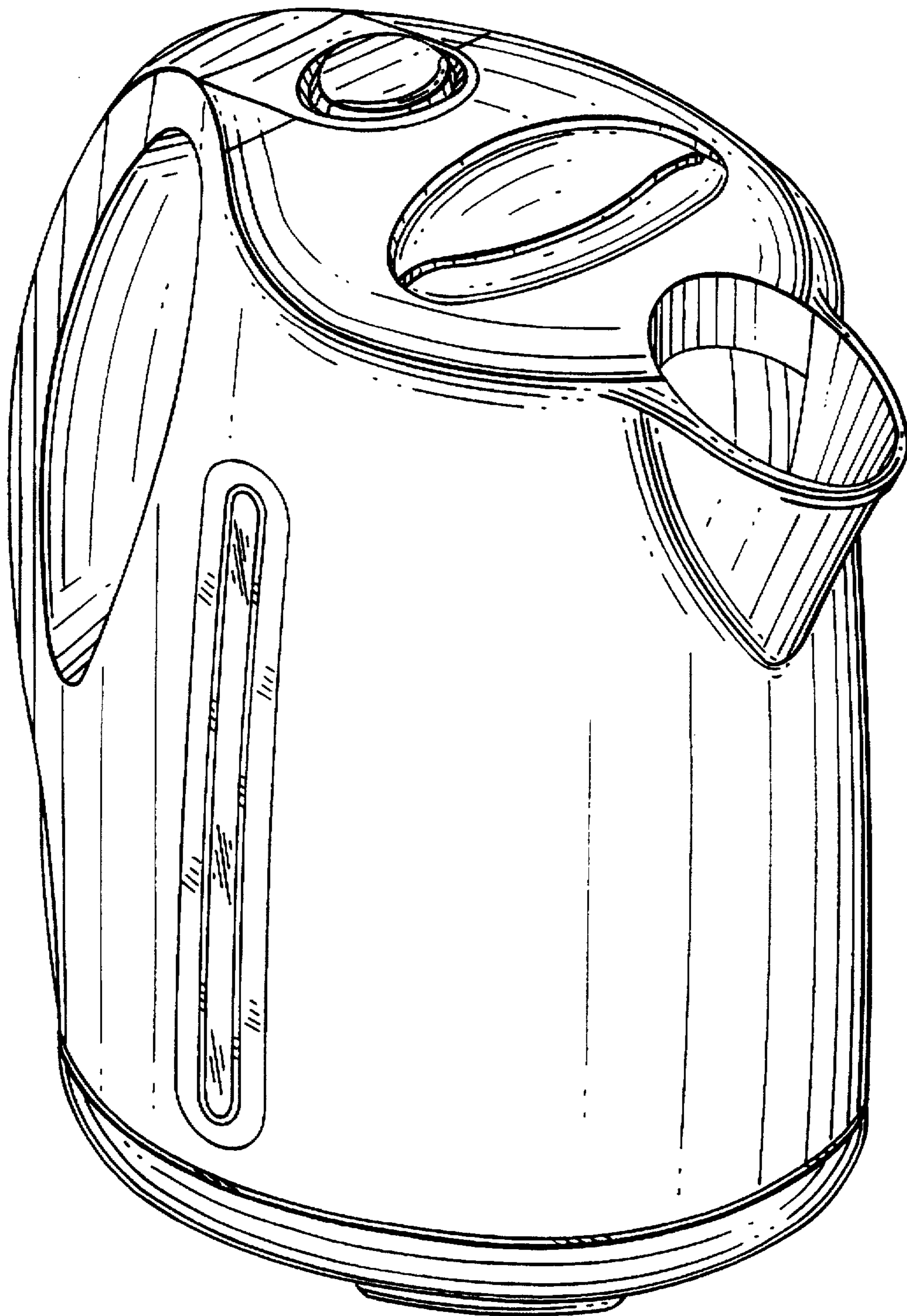

FIG. 10

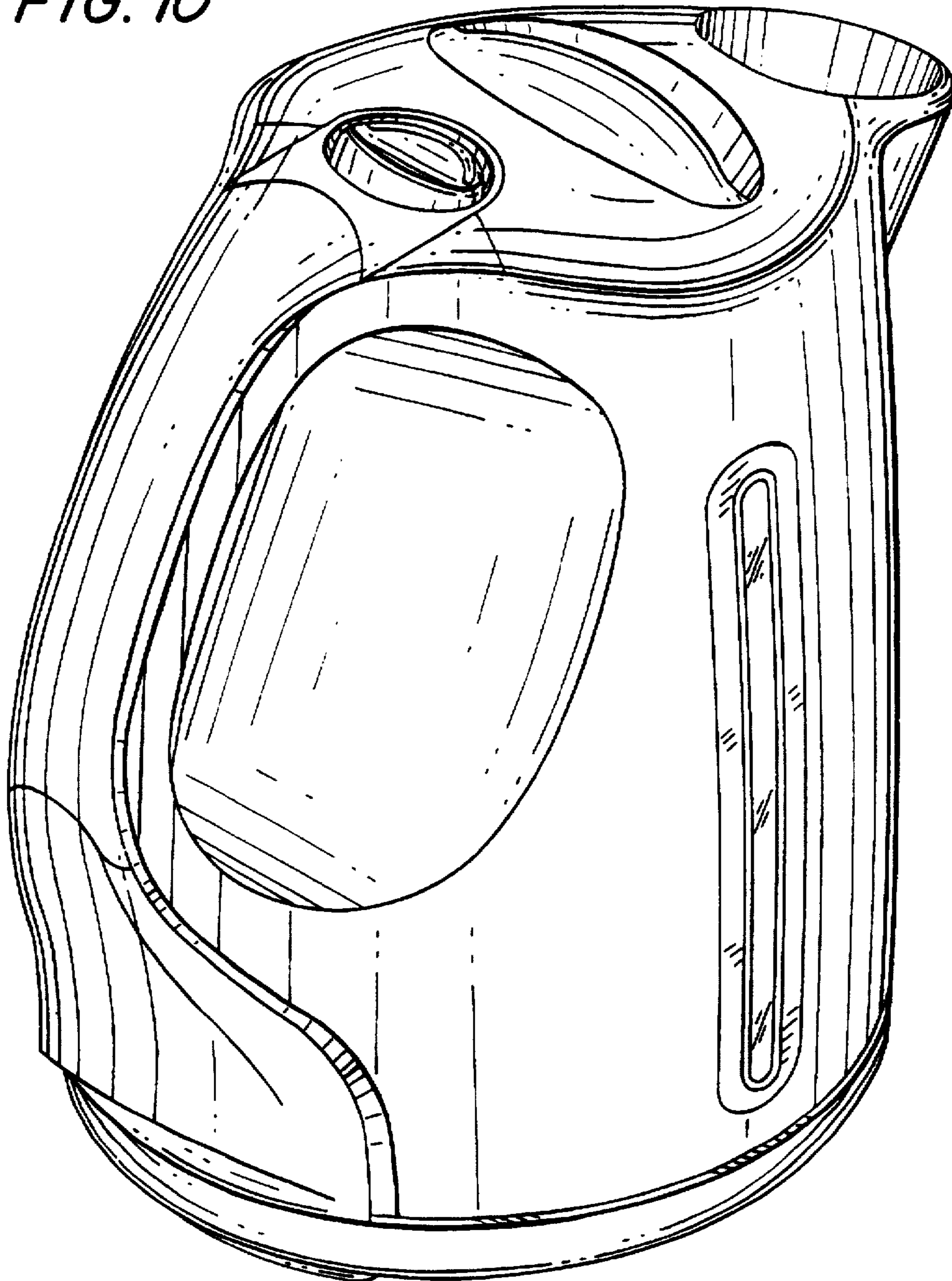

FIG. 11

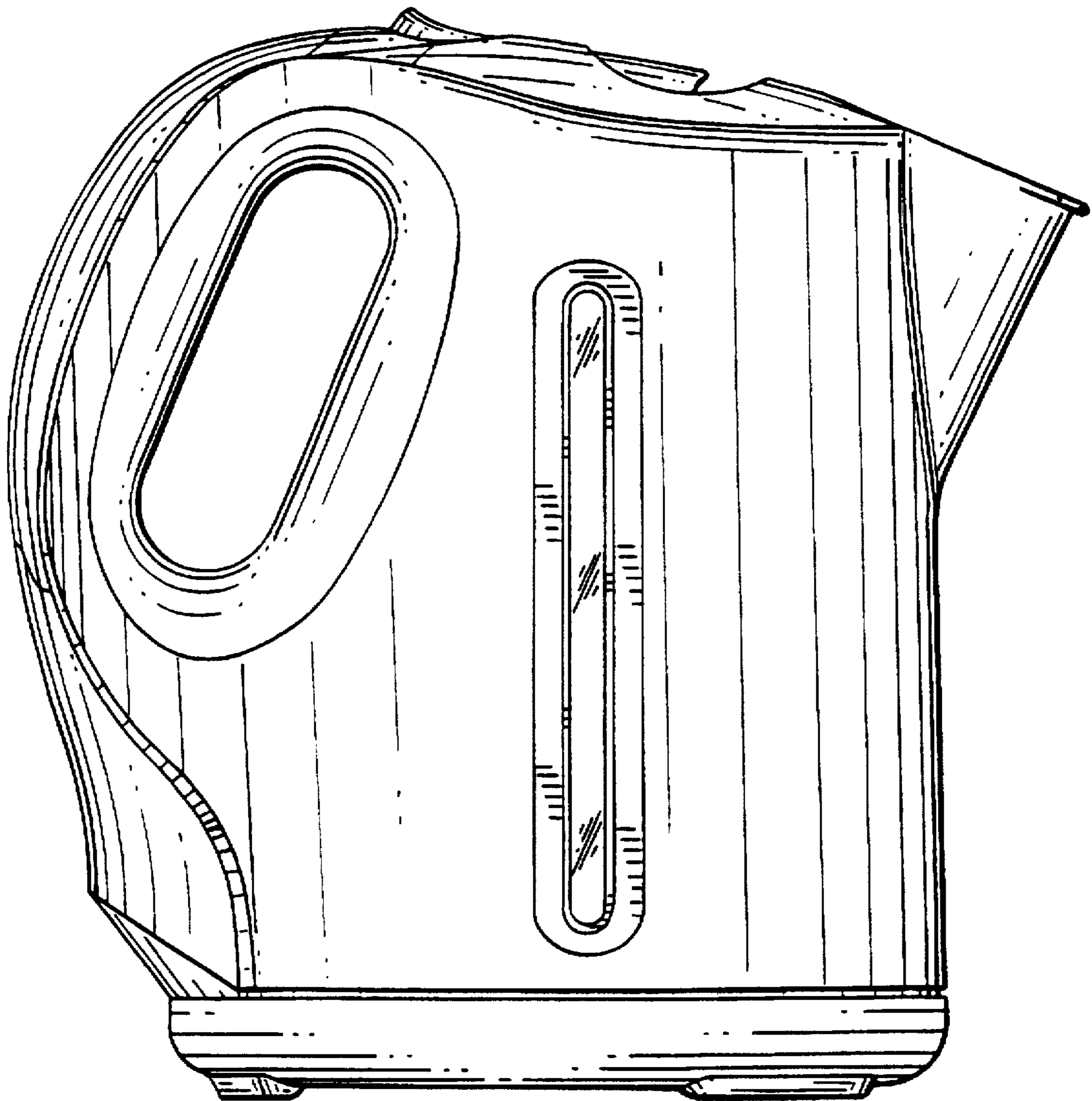

FIG. 12

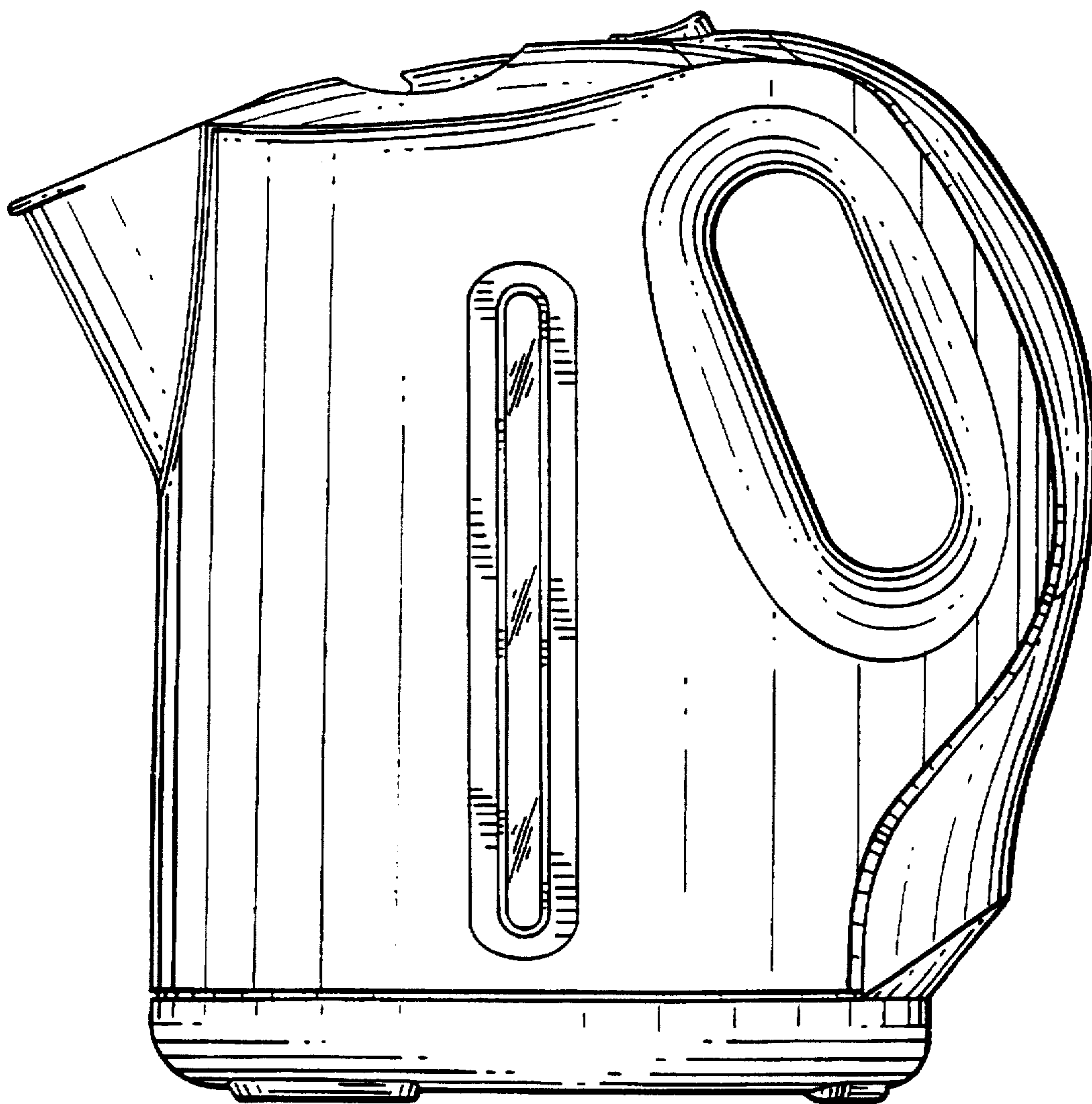
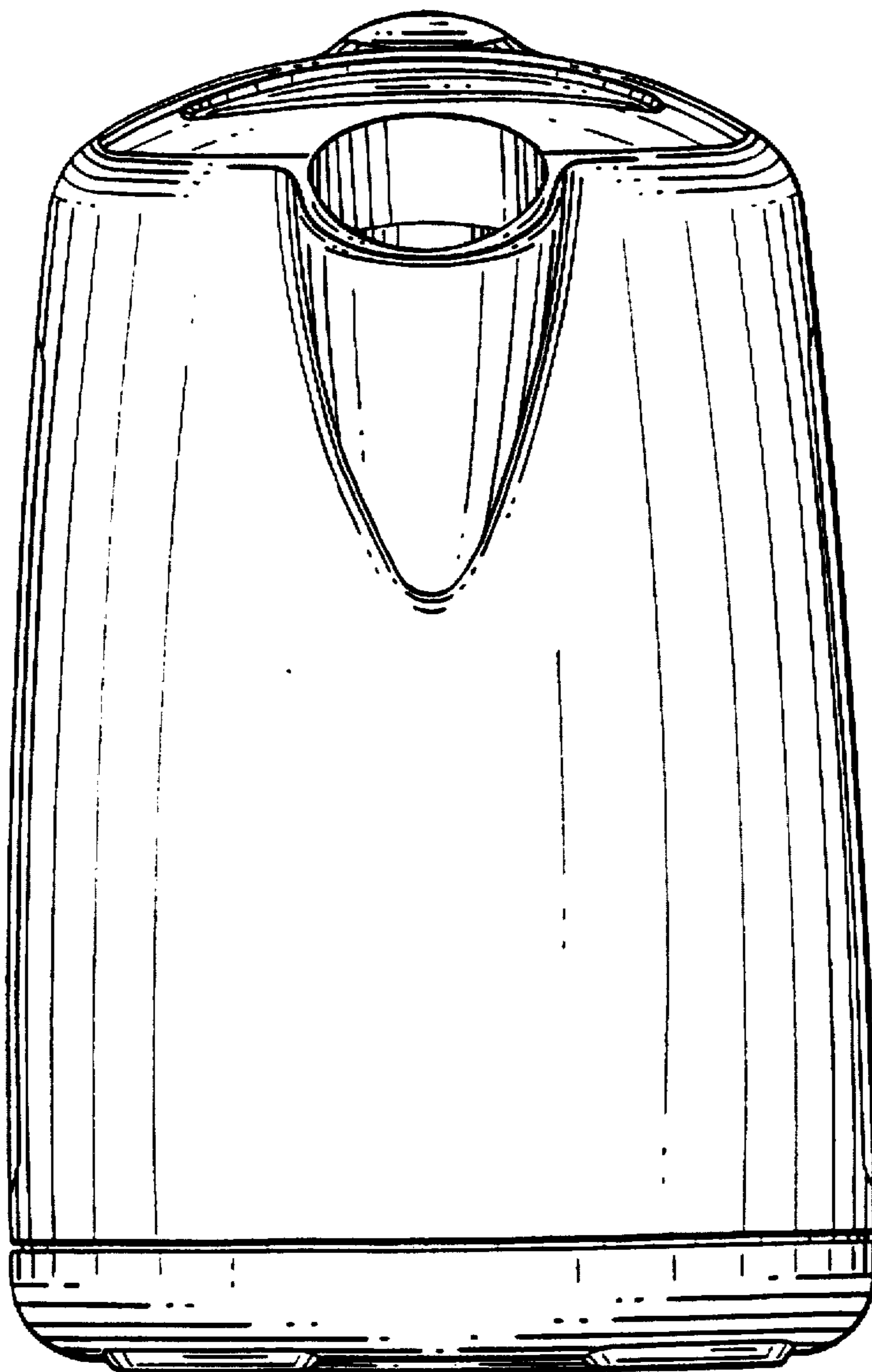

FIG. 13



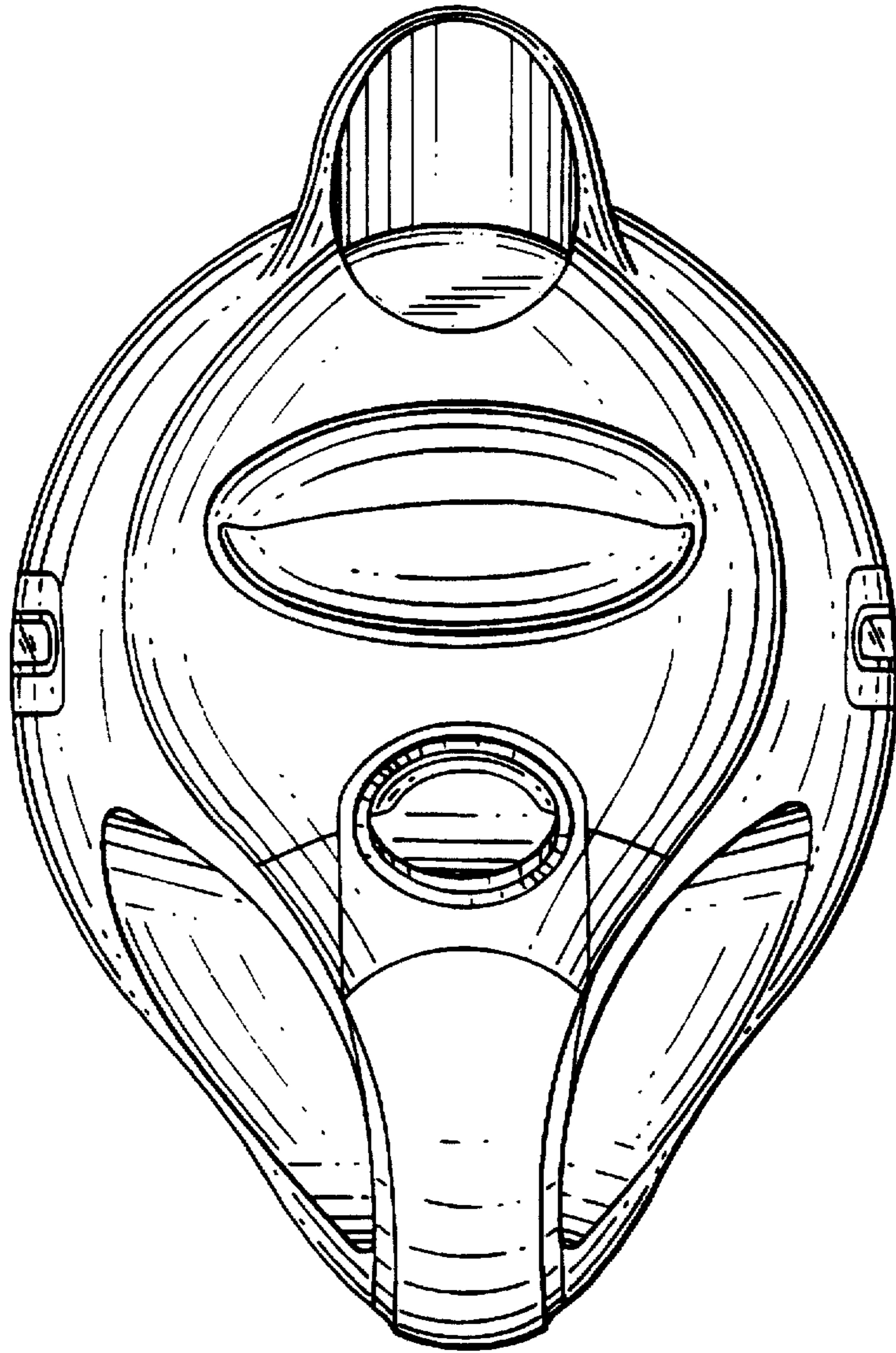

FIG. 14

FIG. 15

