



US00D396359S

# United States Patent [19] Jiang

[11] Patent Number: **Des. 396,359**  
[45] Date of Patent: **\*\*Jul. 28, 1998**

[54] **CHAIR**

[75] Inventor: **Biing-Kwei Jiang**, Taichung Hsien, Taiwan

[73] Assignee: **Chu Chiang**, Taichung Hsien, Taiwan; a part interest

[\*\*] Term: **14 Years**

[21] Appl. No.: **71,552**

[22] Filed: **Jun. 2, 1997**

[30] **Foreign Application Priority Data**

Feb. 27, 1997 [TW] Taiwan ..... 86301621

[51] LOC (6) Cl. .... **06-01**

[52] U.S. Cl. .... **D6/370; D6/380**

[58] Field of Search ..... D6/334, 369, 370, D6/374, 379, 380, 500, 501, 502; 297/446.1

[56] **References Cited**

**U.S. PATENT DOCUMENTS**

D. 82,338 10/1930 McArthur, Jr. .... D6/370

- D. 278,870 5/1985 Giorgetti ..... D6/369
- D. 287,672 1/1987 Holl ..... D6/370
- D. 292,656 11/1987 Masterton ..... D6/370
- D. 355,535 2/1995 Ward ..... D6/370
- D. 374,995 10/1996 Graham et al. .... D6/380

*Primary Examiner*—Gary D. Watson  
*Attorney, Agent, or Firm*—Peterson, Wicks, Nemer & Kamrath, P.A.

[57] **CLAIM**

The ornamental design for a chair, as shown and described.

**DESCRIPTION**

FIG. 1 is a front-left-top perspective view of a chair, showing my new design;  
FIG. 2 is a front elevational view thereof;  
FIG. 3 is a rear elevational view thereof;  
FIG. 4 is a left side elevational view thereof (the right side elevational view being a mirror image thereof);  
FIG. 5 is a top plan view thereof; and,  
FIG. 6 is a bottom plan view thereof.

**1 Claim, 3 Drawing Sheets**

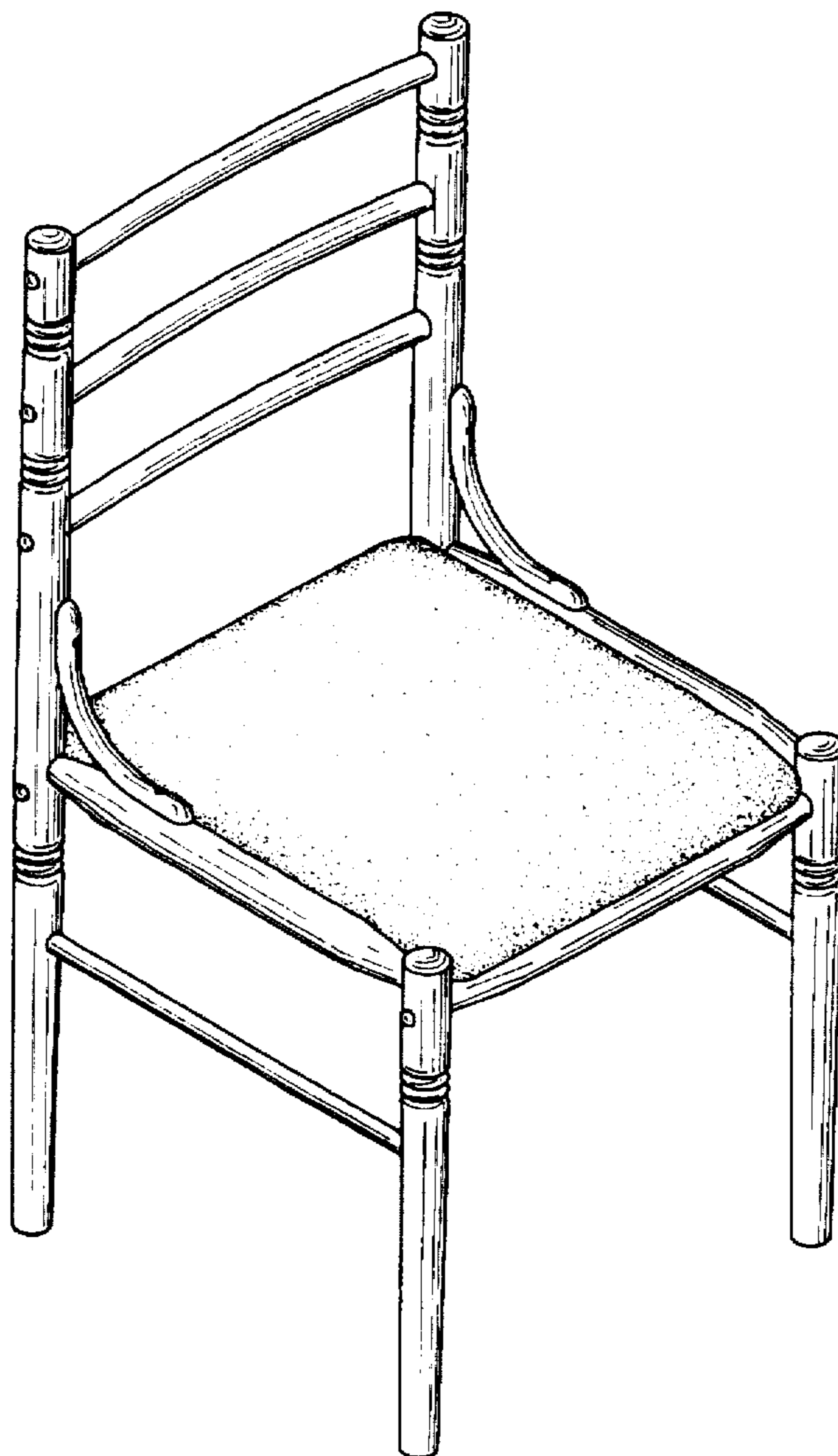

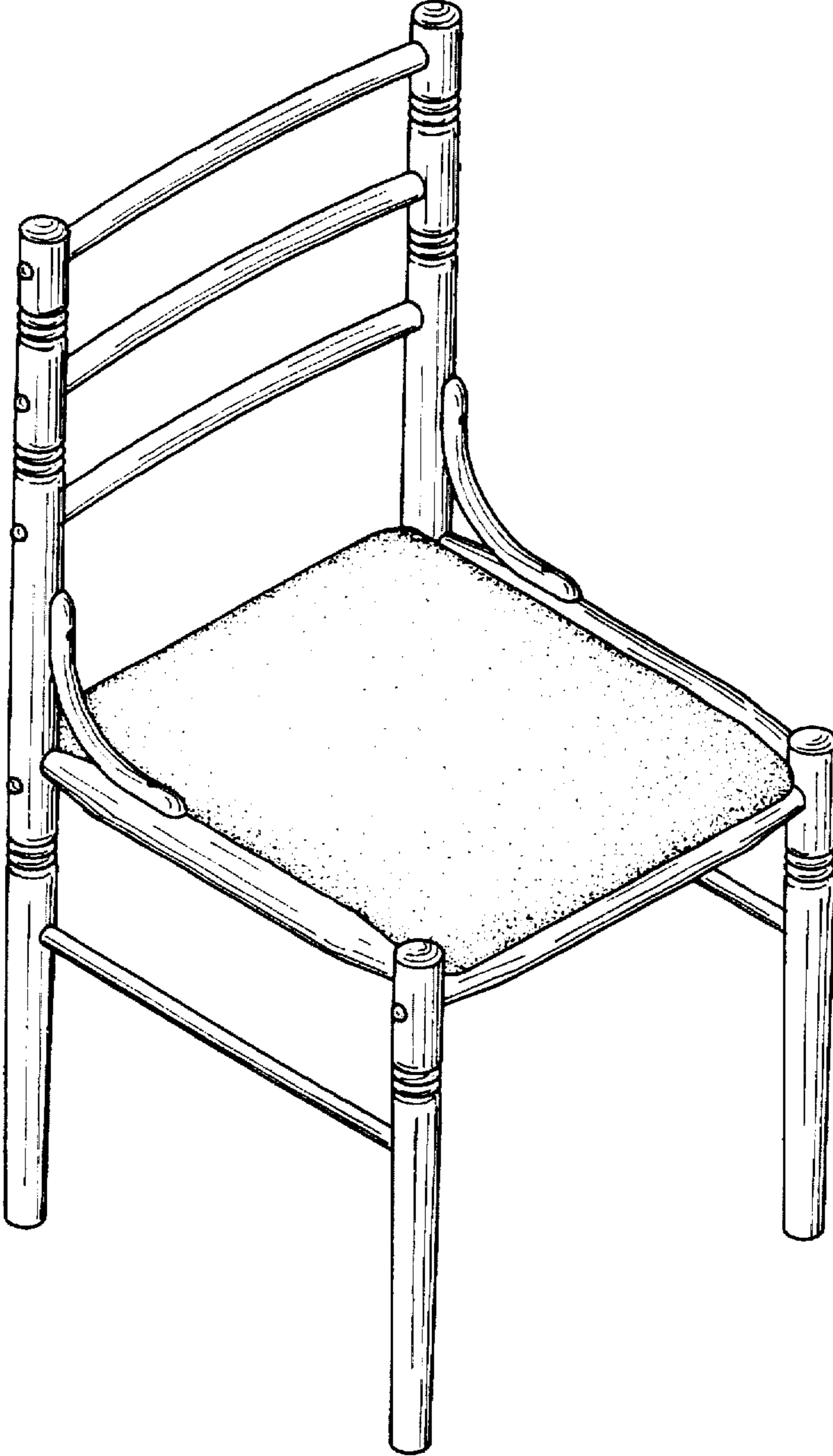

FIG. 1

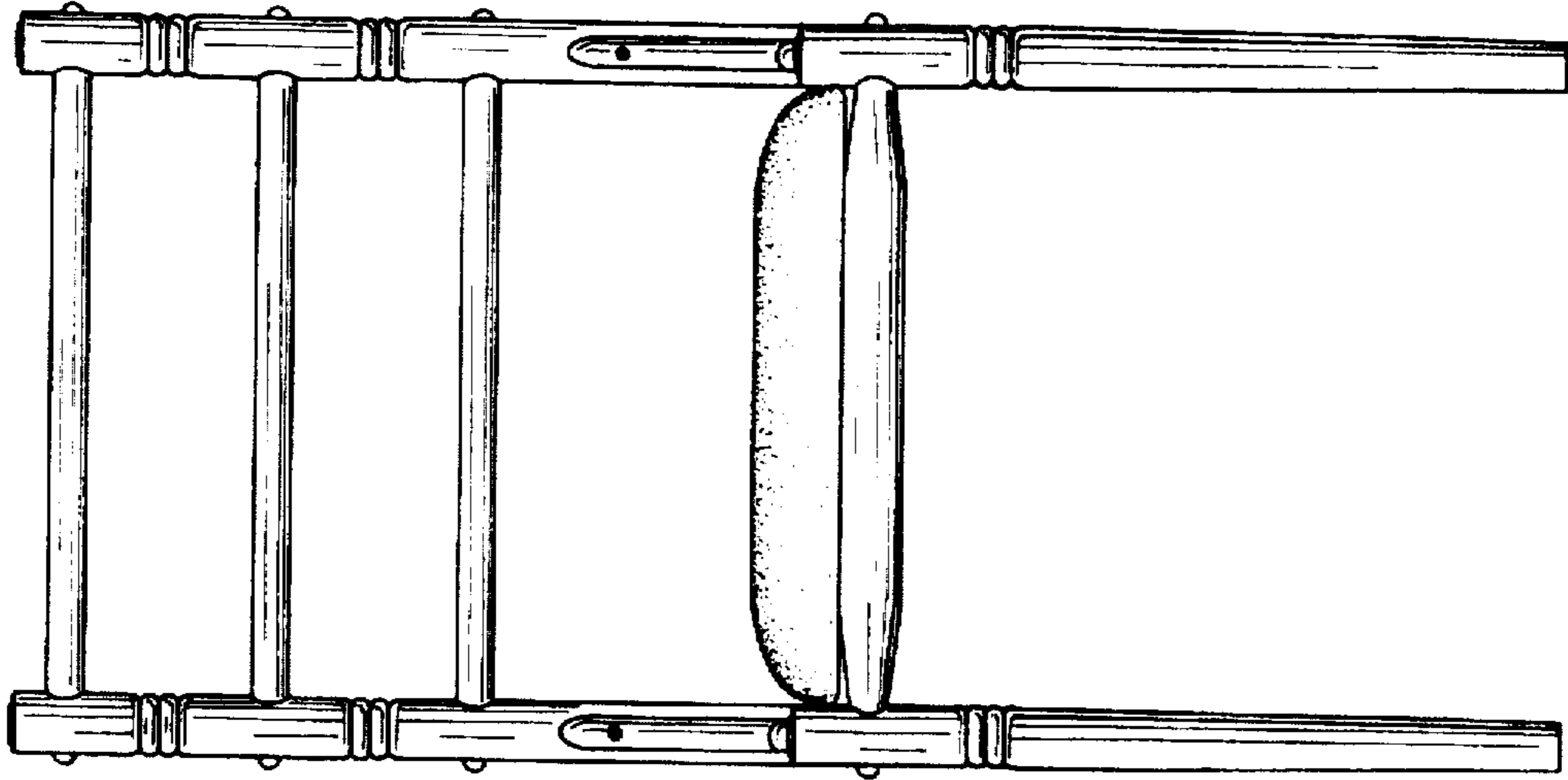

FIG. 2

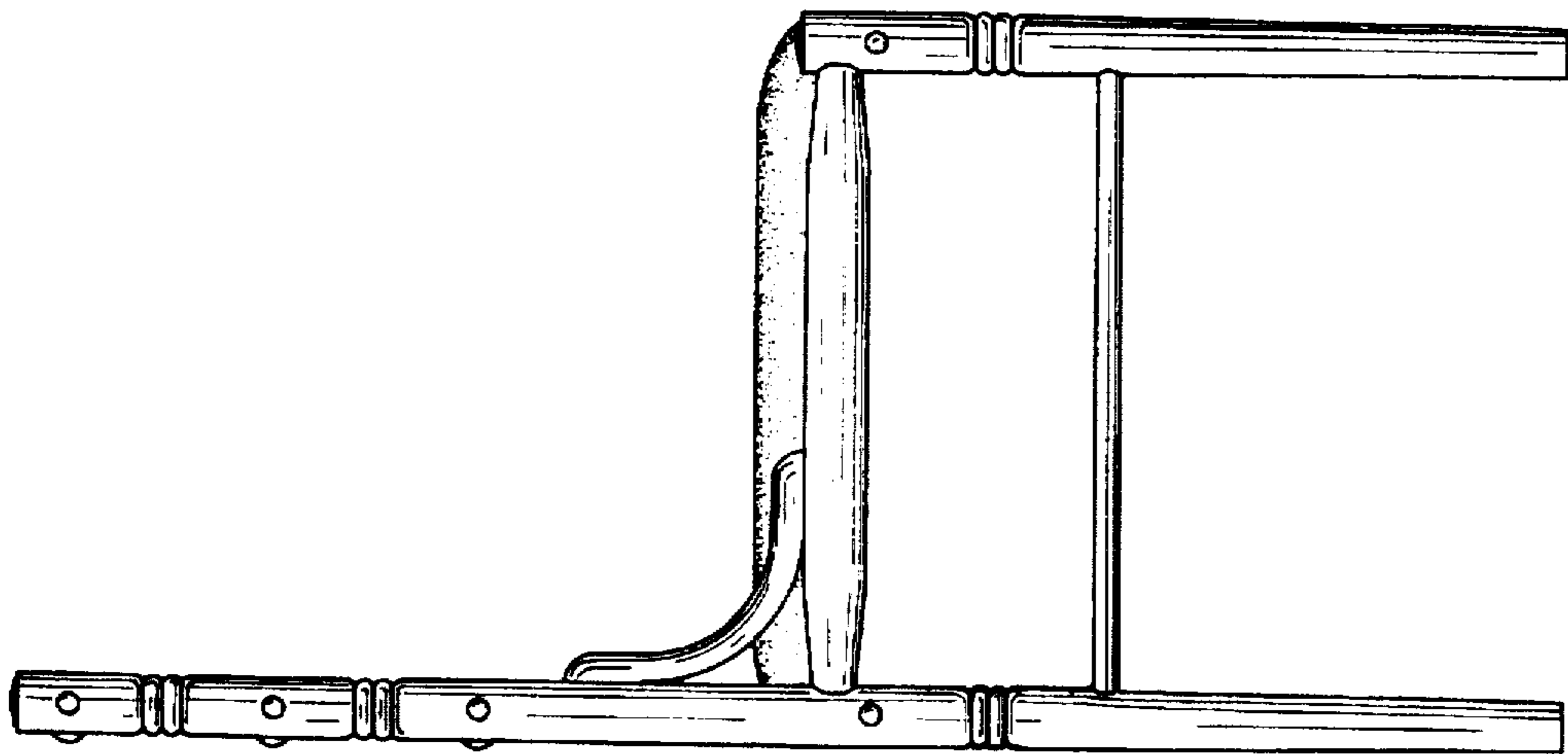

FIG. 4

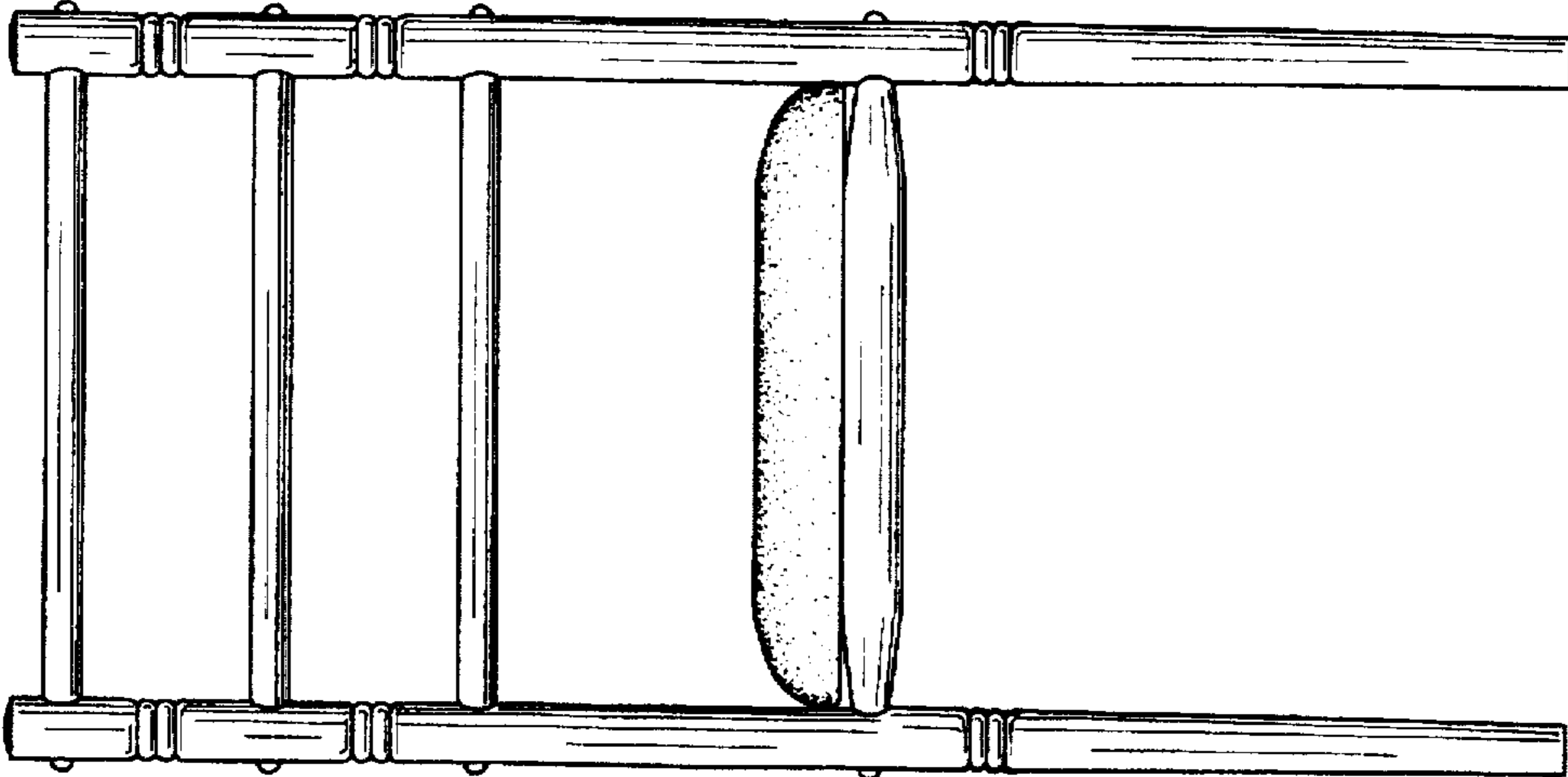

FIG. 3

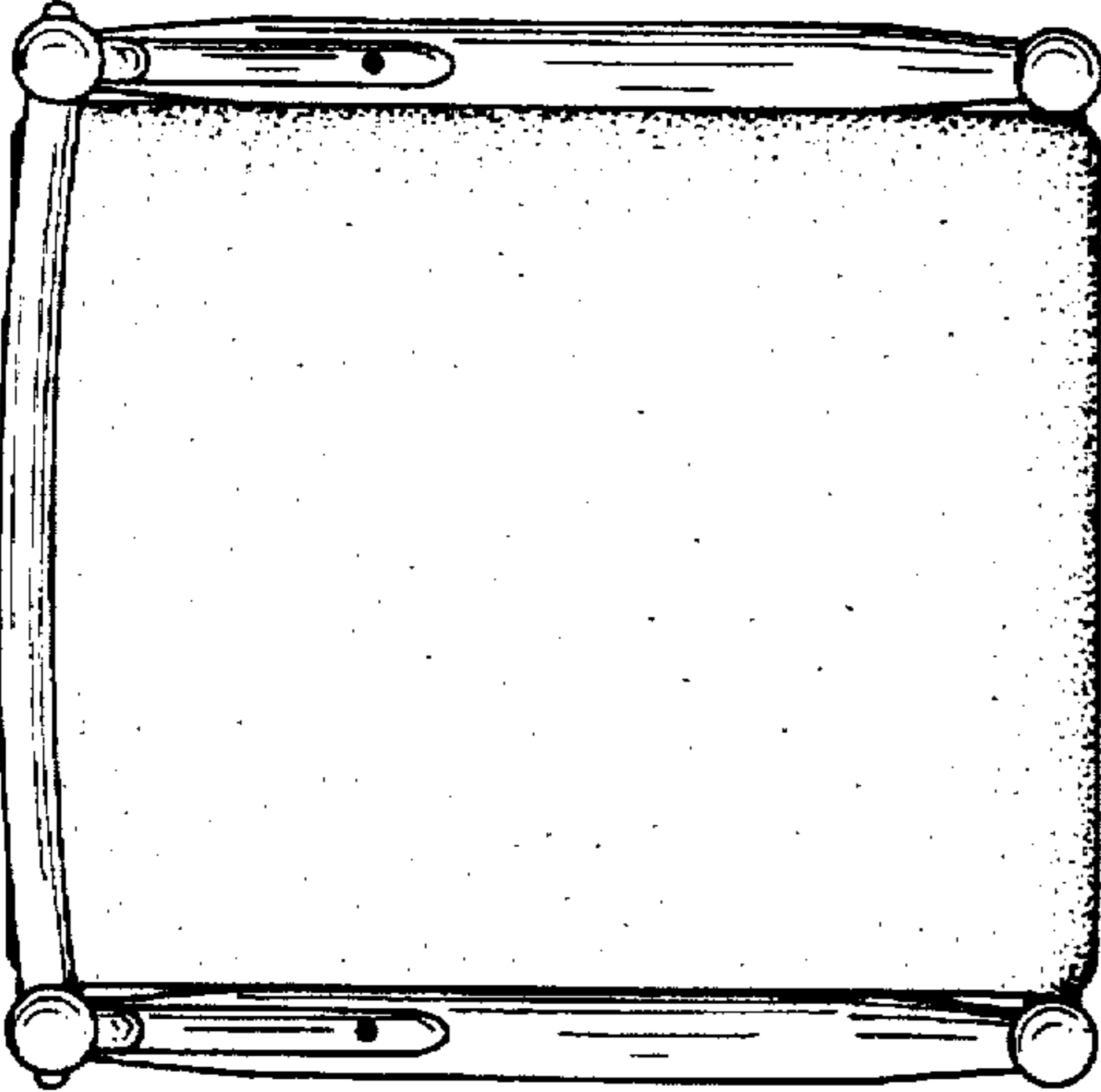

FIG. 5

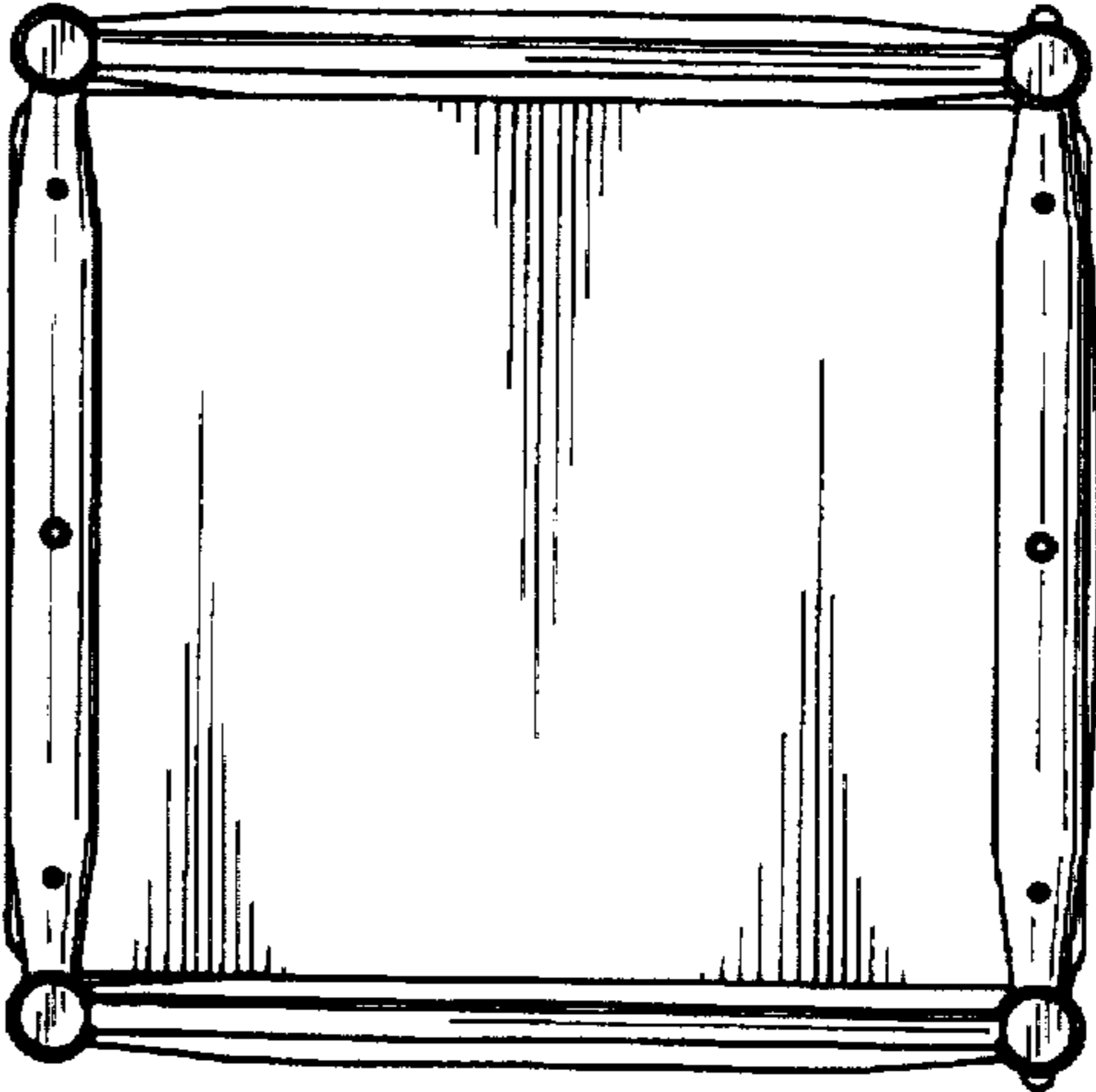

FIG. 6