



US00D396286S

United States Patent [19]
Hipps et al.

[11] **Patent Number: Des. 396,286**
[45] **Date of Patent: **Jul. 21, 1998**

[54] **HEART VALVE RETRACTOR HEAD FOR ENDOSCOPIC ASSEMBLY AND USE**

[75] **Inventors: W. Michael Hipps, Roswell; William R. Mayfield, Atlanta; Gregory R. Furnish, Lawrenceville, all of Ga.**

[73] **Assignee: Genzyme Corporation, Tucker, Ga.**

[**] **Term: 14 Years**

[21] **Appl. No.: 60,272**

[22] **Filed: Sep. 25, 1996**

[51] **LOC (6) Cl. 24-02**

[52] **U.S. Cl. D24/138**

[58] **Field of Search D24/133, 135, D24/137, 138; 600/201, 213, 216, 217, 219**

[56] **References Cited**

U.S. PATENT DOCUMENTS

D. 171,169	12/1953	Stegeman	D24/138
5,167,223	12/1992	Kons et al.	600/201
5,297,538	3/1994	Daniel	600/207
5,509,890	4/1996	Kazama	600/37
5,529,517	6/1996	Daniel	600/219
5,571,215	11/1996	Sterman et al.	623/66

OTHER PUBLICATIONS

Heartport® Atrial Retractor Sets Instructions for Use (Feb. 1997).

Primary Examiner—Doris Clark
Attorney, Agent, or Firm—Needle & Rosenberg, P.C.

[57] **CLAIM**

The ornamental design for a heart valve retractor head for endoscopic assembly and use, as shown and described.

DESCRIPTION

FIG. 1 is a perspective view showing the front, top, and left side of my new design for a heart valve retractor head for endoscopic assembly and use;
FIG. 2 is a right side elevational view of the heart valve retractor head for endoscopic assembly and use of FIG. 1, the opposite side being a mirror;
FIG. 3 is a front elevational view of the heart valve retractor head for endoscopic assembly and use of FIG. 1;
FIG. 4 is a rear elevational view of the heart valve retractor head for endoscopic assembly and use of FIG. 1;
FIG. 5 is a top plan view of the heart valve retractor head for endoscopic assembly and use of FIG. 1; and,
FIG. 6 is a bottom plan view of the heart valve retractor head for endoscopic assembly and use of FIG. 1.

1 Claim, 1 Drawing Sheet

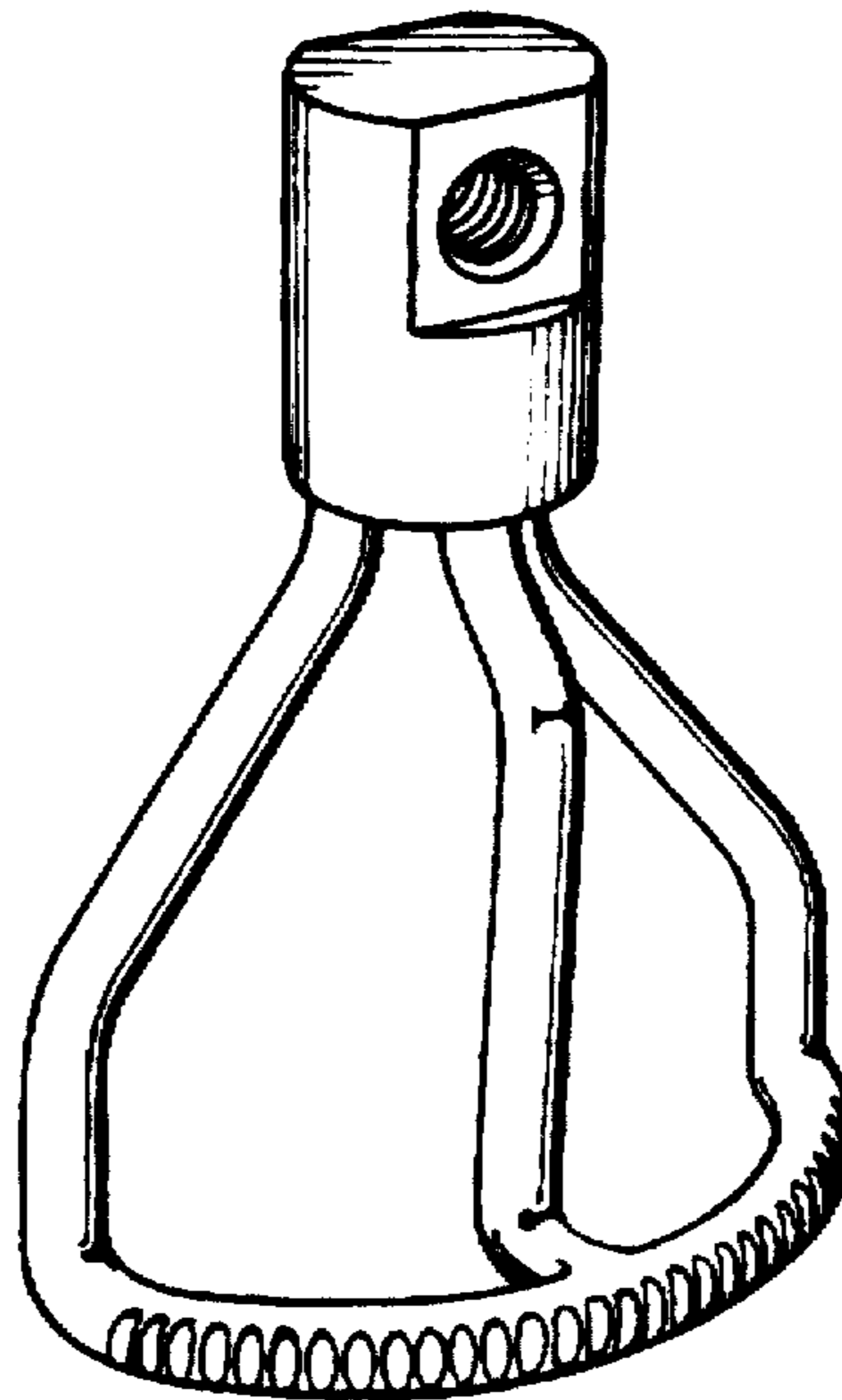

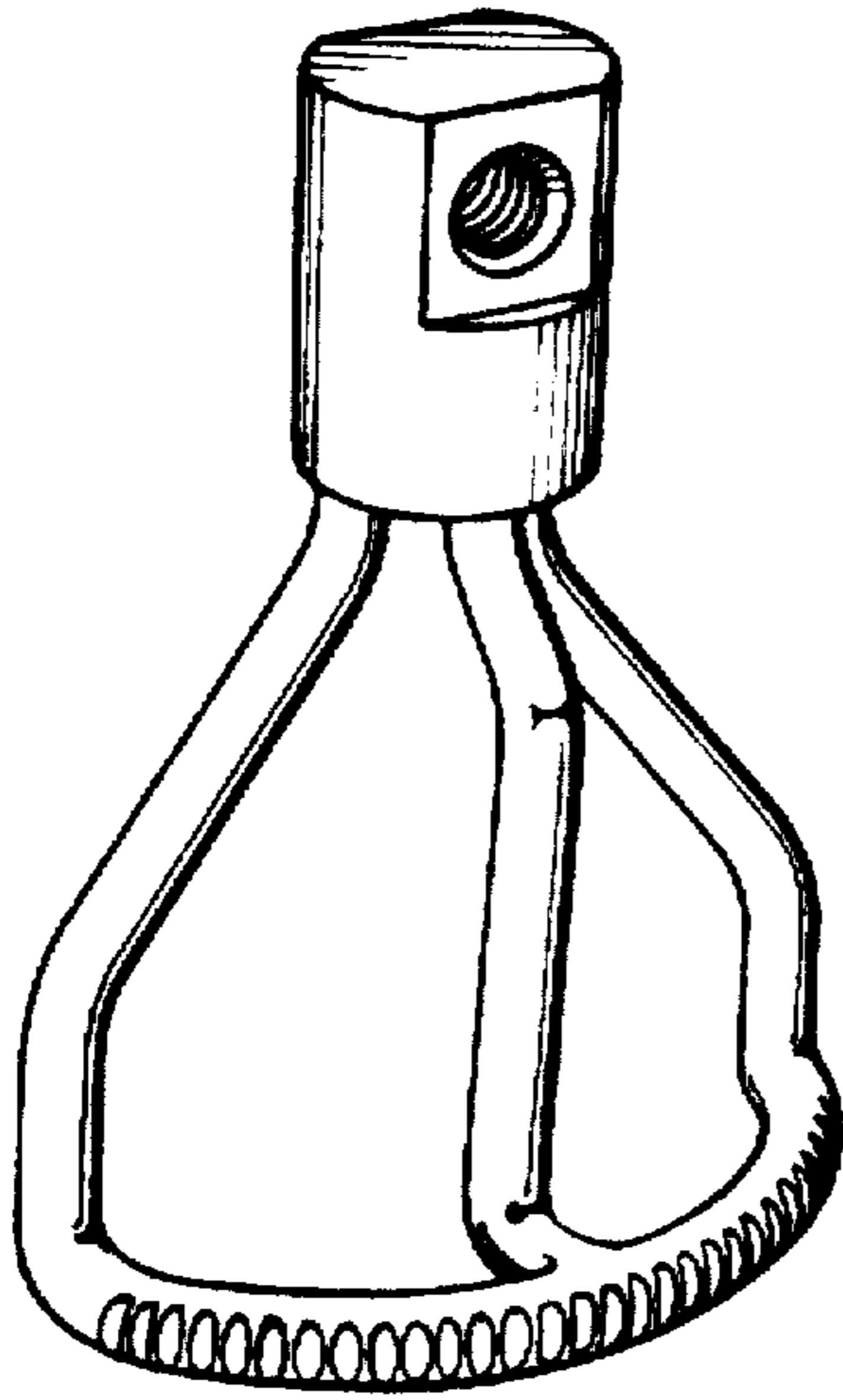

FIG 1

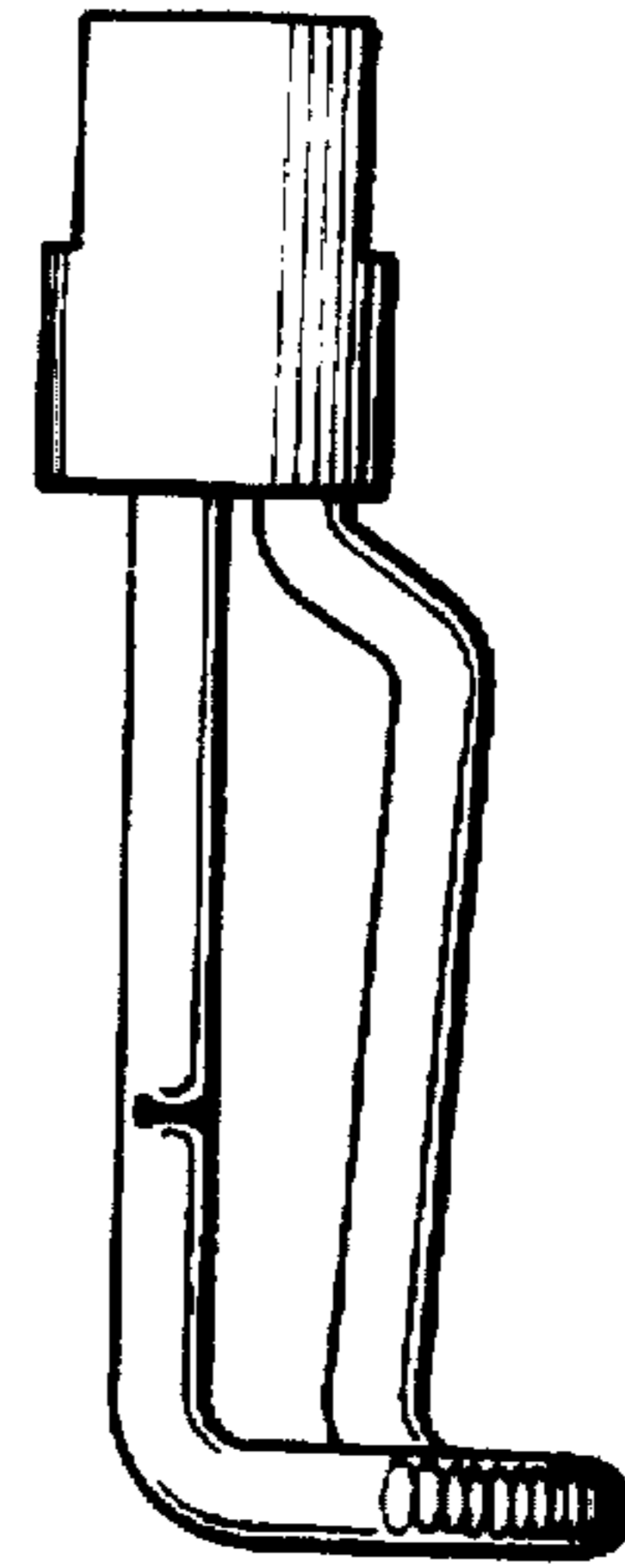

FIG 2

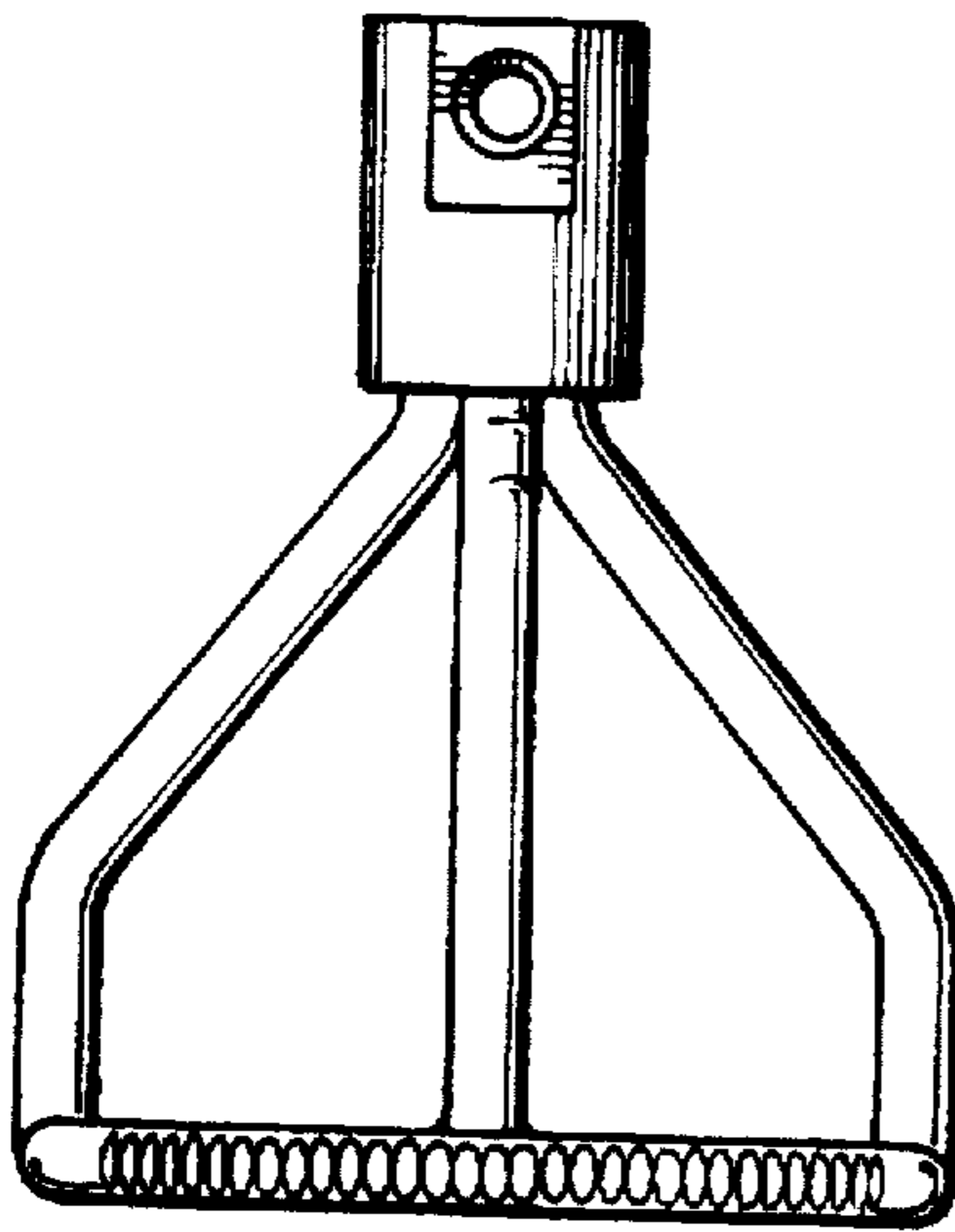

FIG 3

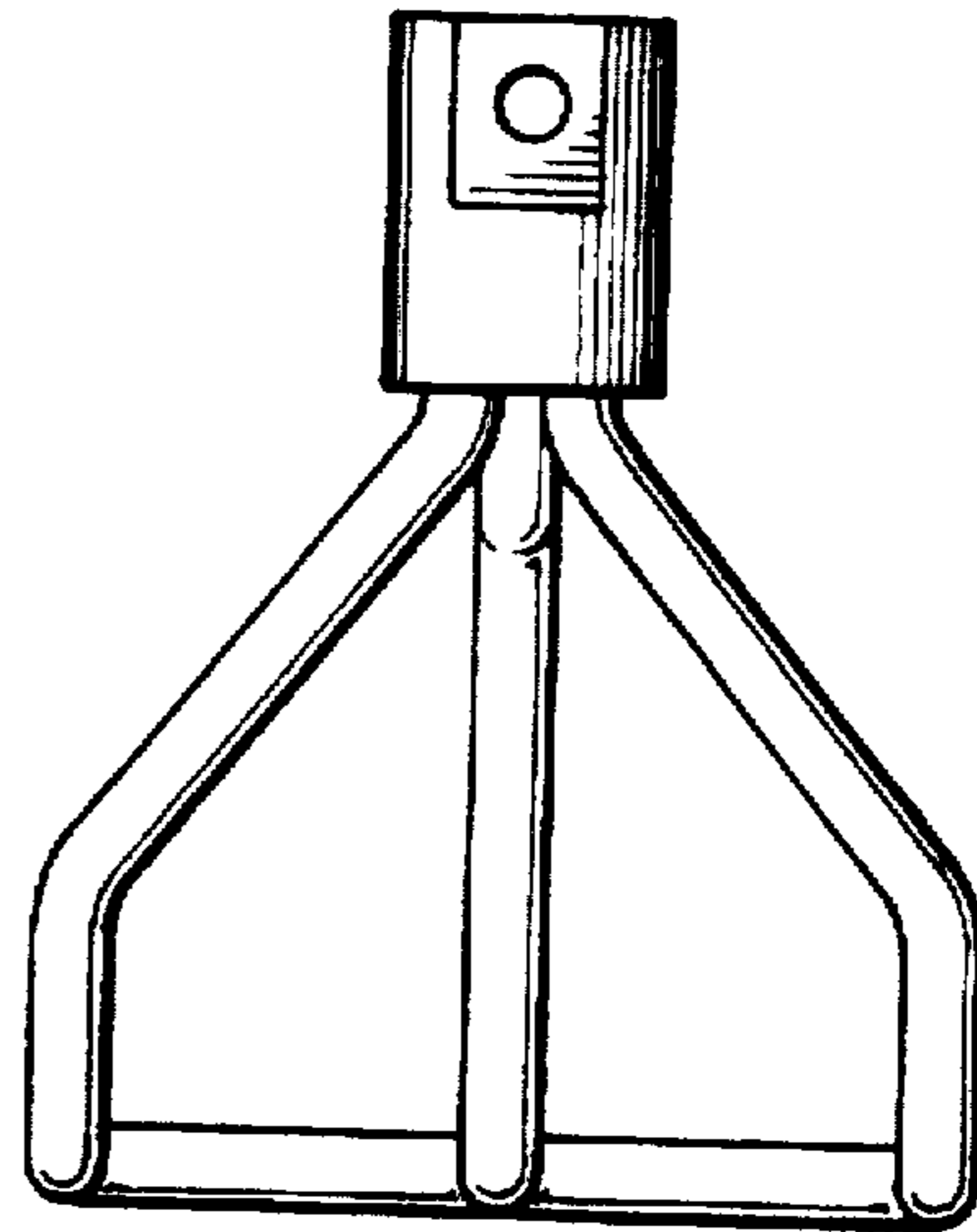

FIG 4

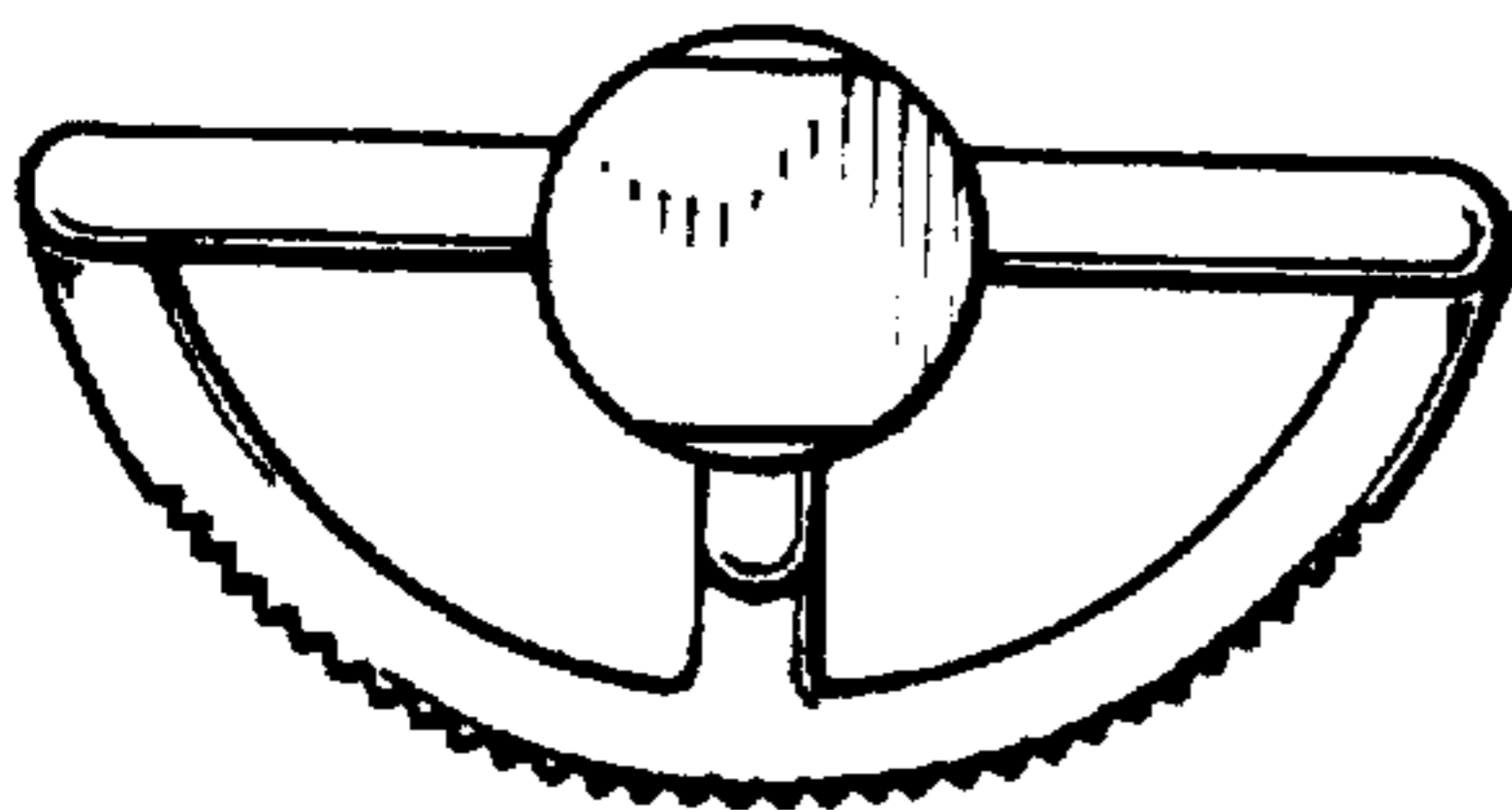

FIG 5

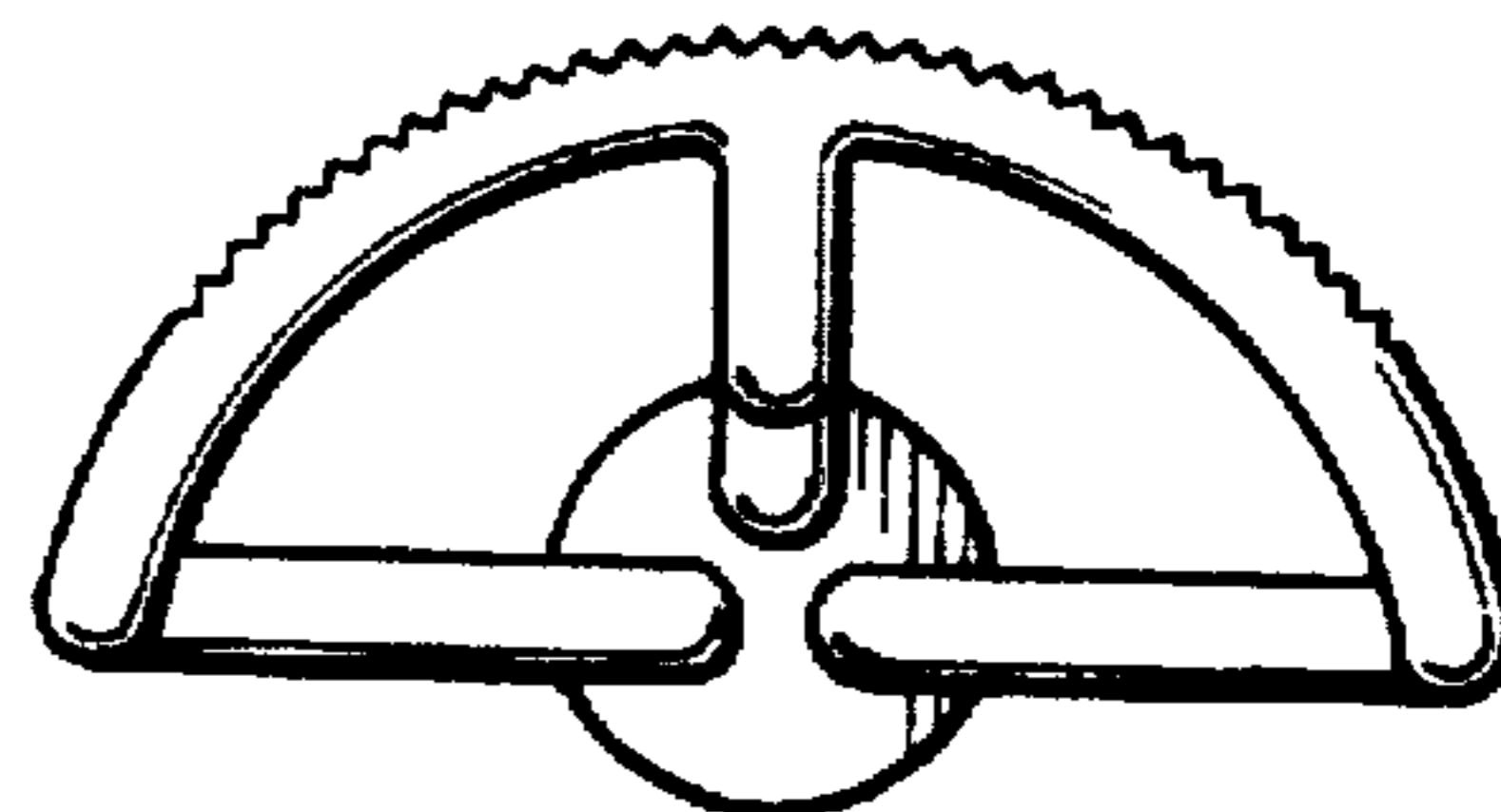

FIG 6