

US00D396168S

# United States Patent [19]

Cohen et al.

[11] Patent Number: Des. 396,168

[45] Date of Patent: \*\*Jul. 21, 1998

[54] HANDLE FOR KITCHEN TOOLS AND GADGETS

[75] Inventors: Milton L. Cohen, Hewlett Bay Park; Jeff Siegel, Great Neck; Adam Krent, Brooklyn, all of N.Y.

[73] Assignee: Lifetime Hoan Corporation, Westbury, N.Y.

[\*\*] Term: 14 Years

[21] Appl. No.: 67,730

[22] Filed: Mar. 10, 1997

[51] LOC (6) Cl. .... 07-03

[52] U.S. Cl. .... D7/395; D7/401.2

[58] Field of Search ..... D7/393-395, 642, D7/645, 649, 650, 401.2, 688, 691, 693; D8/98, 99, 107; 30/147-150, 340-342, 345; 16/110 R, 110 A, 114 R; D22/117, 118

## [56] References Cited

### U.S. PATENT DOCUMENTS

- D. 258,861 4/1981 Bratton et al. .... D7/395
- D. 327,809 7/1992 Hacker ..... D7/395

D. 380,345 7/1997 Lu ..... D7/395

Primary Examiner—Caron D. Veynar  
Attorney, Agent, or Firm—Goodman & Teitelbaum, Esqs.

## [57] CLAIM

The ornamental design for a handle for kitchen tools and gadgets, as shown and described

## DESCRIPTION

FIG. 1 is a perspective view of a handle for kitchen tools and gadgets, showing our new design; FIG. 2 is a top plan view thereof; FIG. 3 is a side elevational view of one side thereof; FIG. 4 is a bottom plan view thereof; FIG. 5 is a side elevational view of the other side thereof; FIG. 6 is a rear elevational view thereof; and, FIG. 7 is a front elevational view thereof.

The broken line showings of a turner in FIGS. 1-7 are for illustrative purposes only and form no part of the claimed design.

The characteristic feature of the design resides in the black body of the handle provided with a metal cover on the top and bottom portions thereof with black resilient finger grips extending through both top and bottom metal covers of the handle.

1 Claim, 2 Drawing Sheets

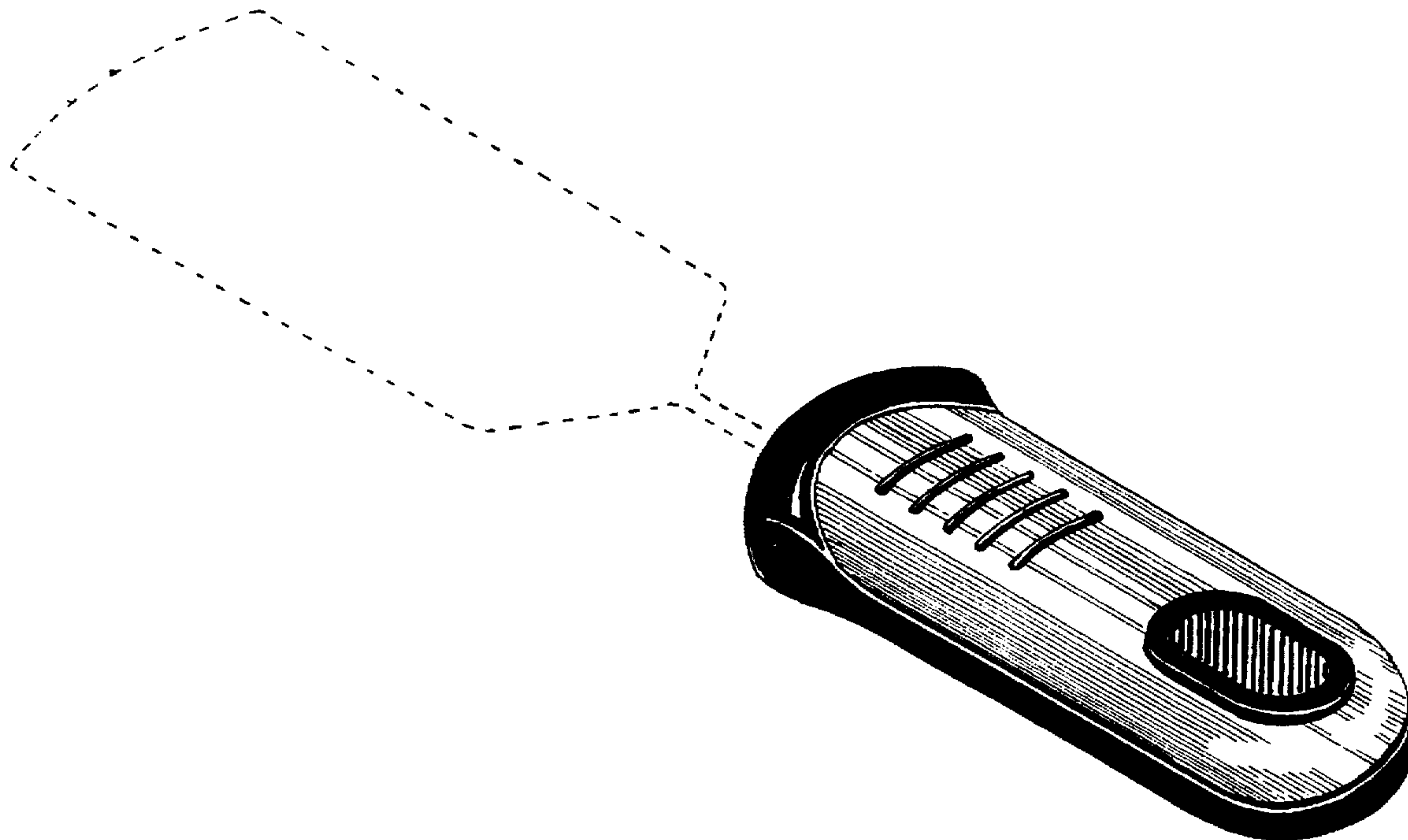

FIG. 6

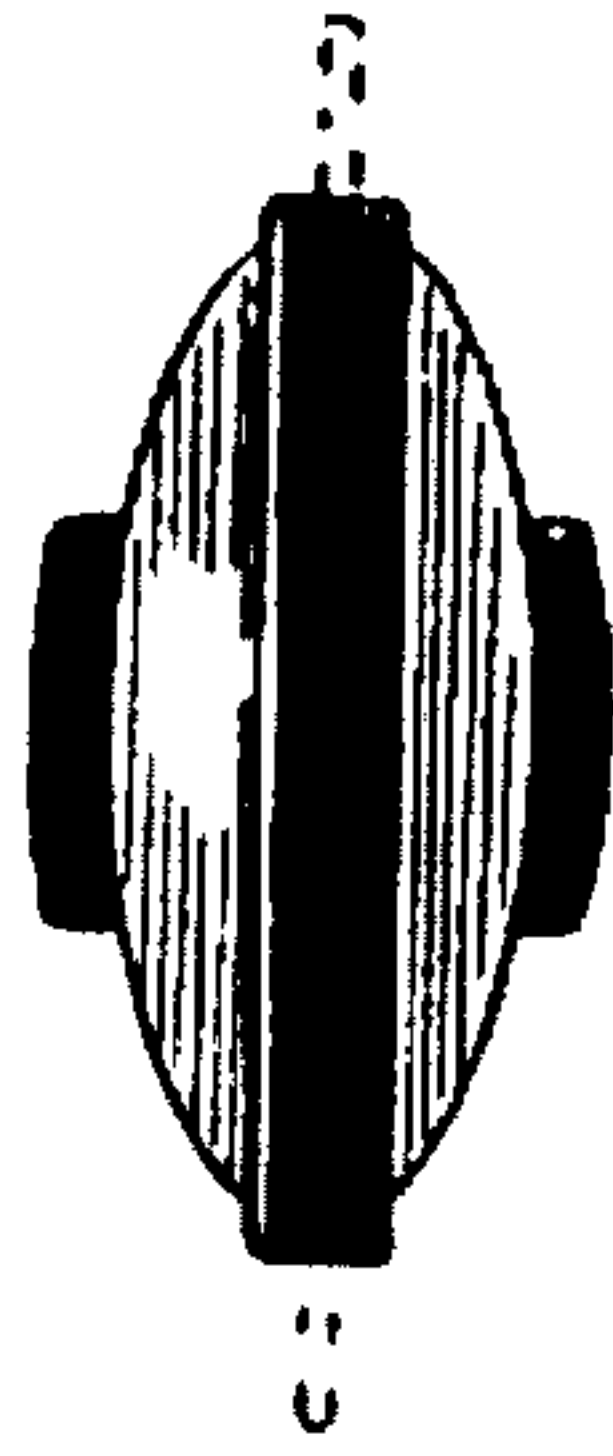

FIG. 1

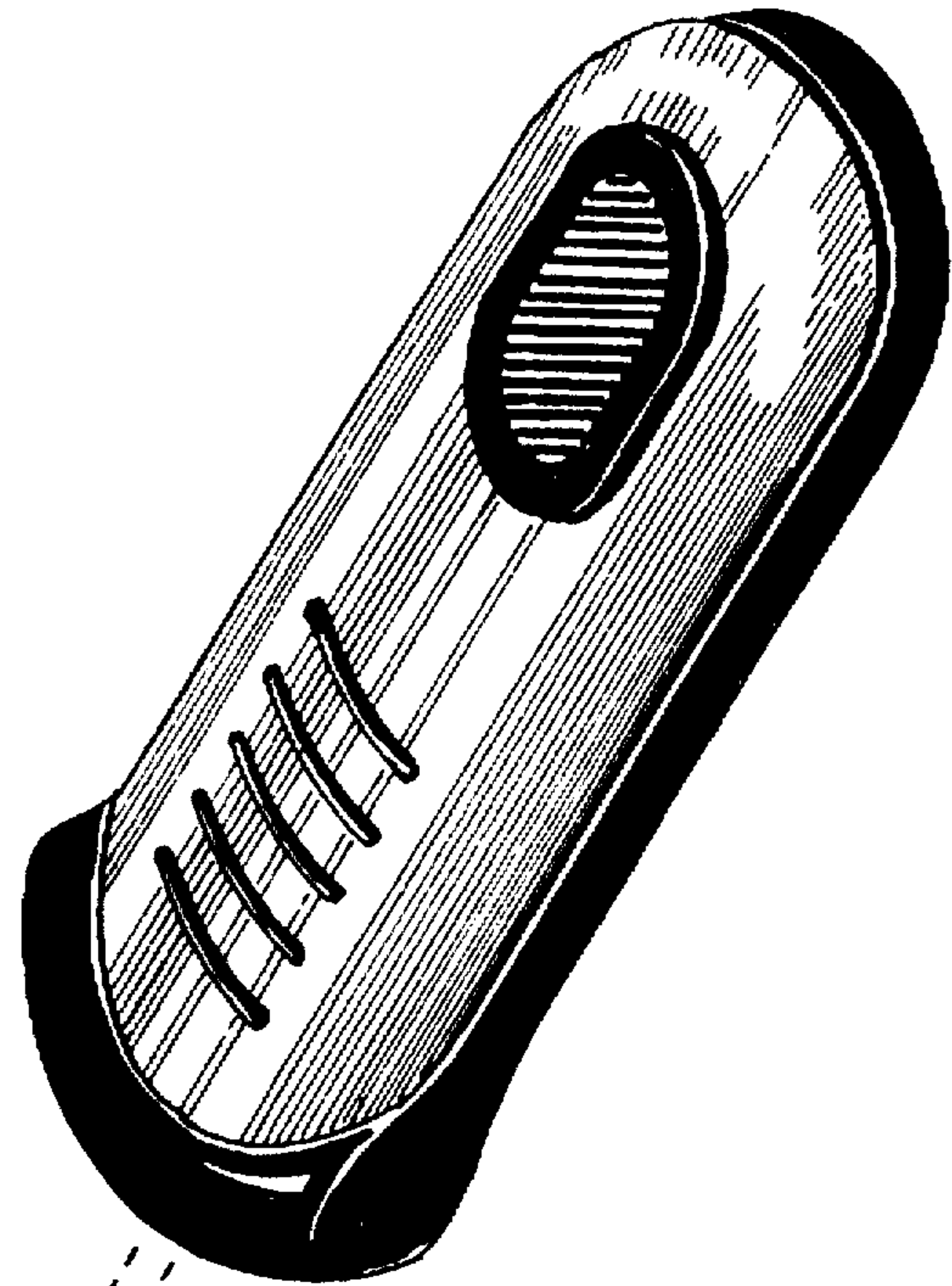
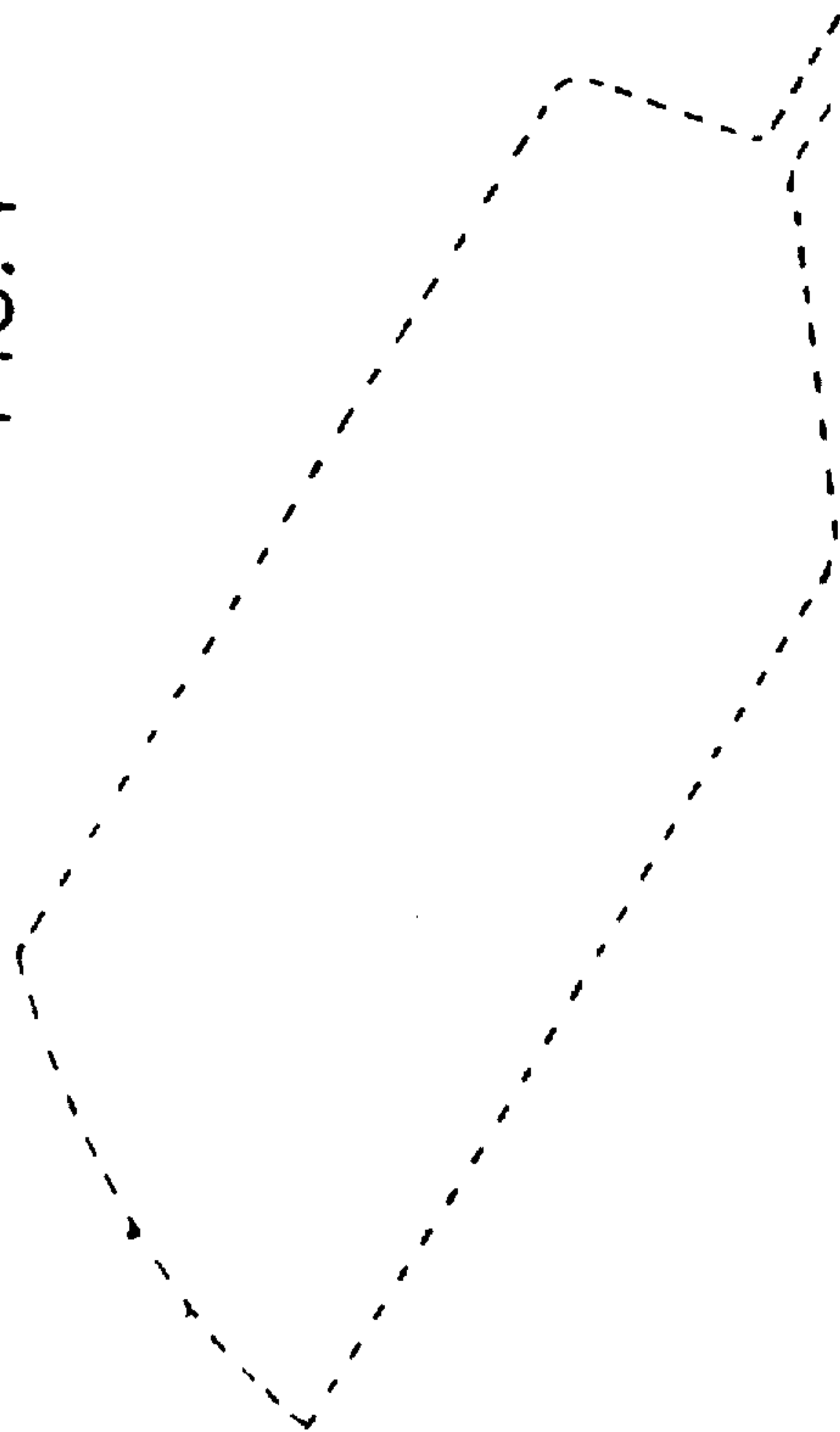

FIG. 7



FIG. 2

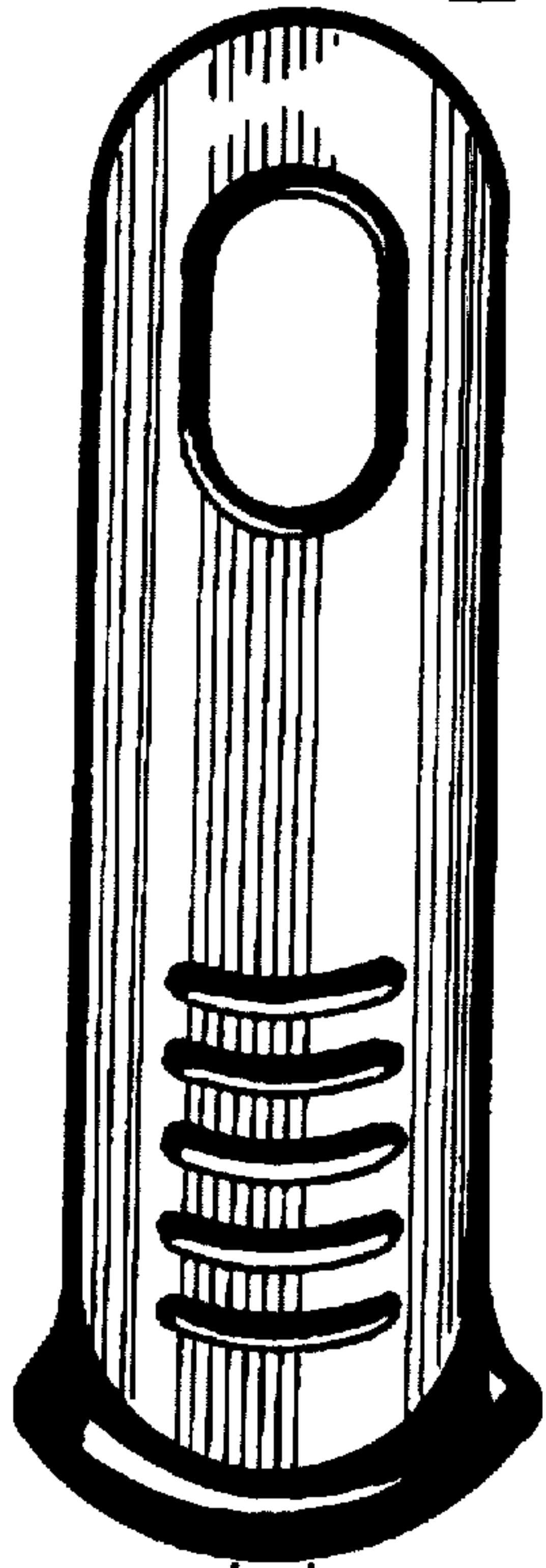

FIG. 3

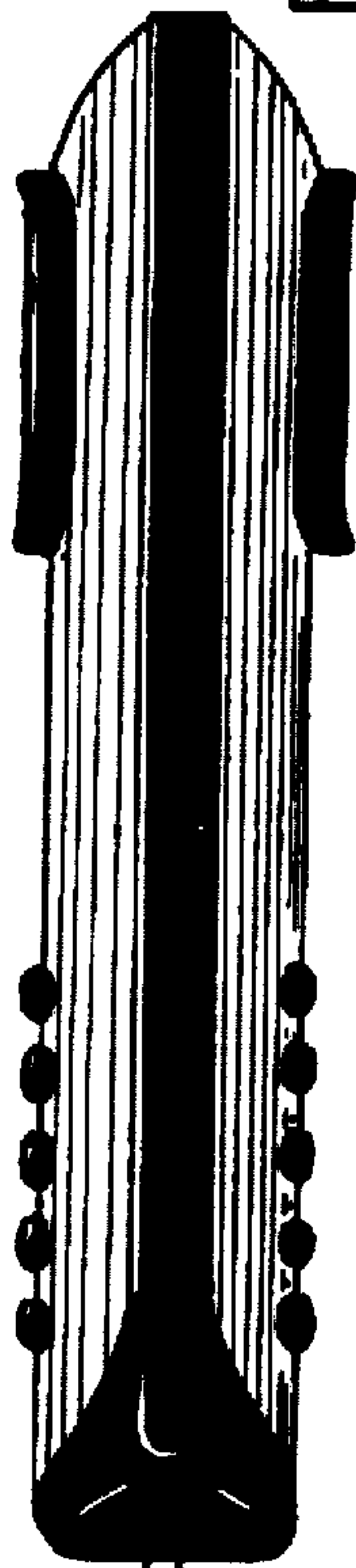

FIG. 4

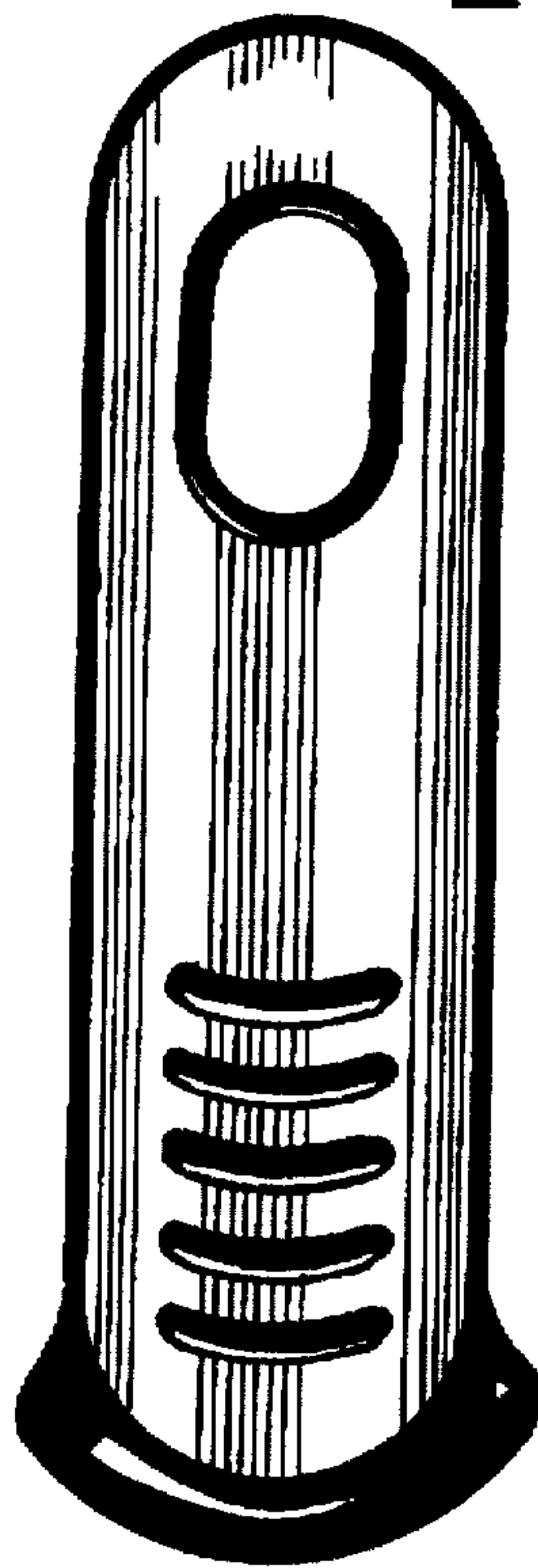

FIG. 5

