



US00D396165S

United States Patent [19]

Peña Angarita

[11] Patent Number: Des. 396,165

[45] Date of Patent: **Jul. 21, 1998

[54] TOASTER

[75] Inventor: Oscar Enrique Peña Angarita,
Veldhoven, Netherlands

[73] Assignee: U.S. Philips Corporation, New York,
N.Y.

[**] Term: 14 Years

[21] Appl. No.: 79,303

[22] Filed: Nov. 12, 1997

[30] Foreign Application Priority Data

Jul. 1, 1997 [CH] Switzerland DMA003770

[51] LOC (6) Cl. 07-02

[52] U.S. Cl. D7/330

[58] Field of Search D7/323, 328-330,
D7/387, 390; 99/329 R. 331, 332, 334,
335, 372, 385, 389

[56] References Cited

U.S. PATENT DOCUMENTS

D. 150,134 7/1948 Guild D7/330

D. 169,575 5/1953 Budlane et al. D7/330 X
D. 384,542 10/1997 Pena ANgarita D7/330
2,920,551 1/1960 Schmall D7/330 X

Primary Examiner—Caron D. Veynar
Attorney, Agent, or Firm—Ernestine C. Bartlett

[57] CLAIM

The ornamental design for a toaster, as shown.

DESCRIPTION

FIG. 1 is a perspective view showing my design;
FIG. 2 is a front elevational view thereof;
FIG. 3 is a rear elevational view thereof;
FIG. 4 is a right side elevational view thereof;
FIG. 5 is a left side elevational view thereof;
FIG. 6 is a top plan view thereof; and
FIG. 7 is a bottom plan view thereof.

1 Claim, 4 Drawing Sheets

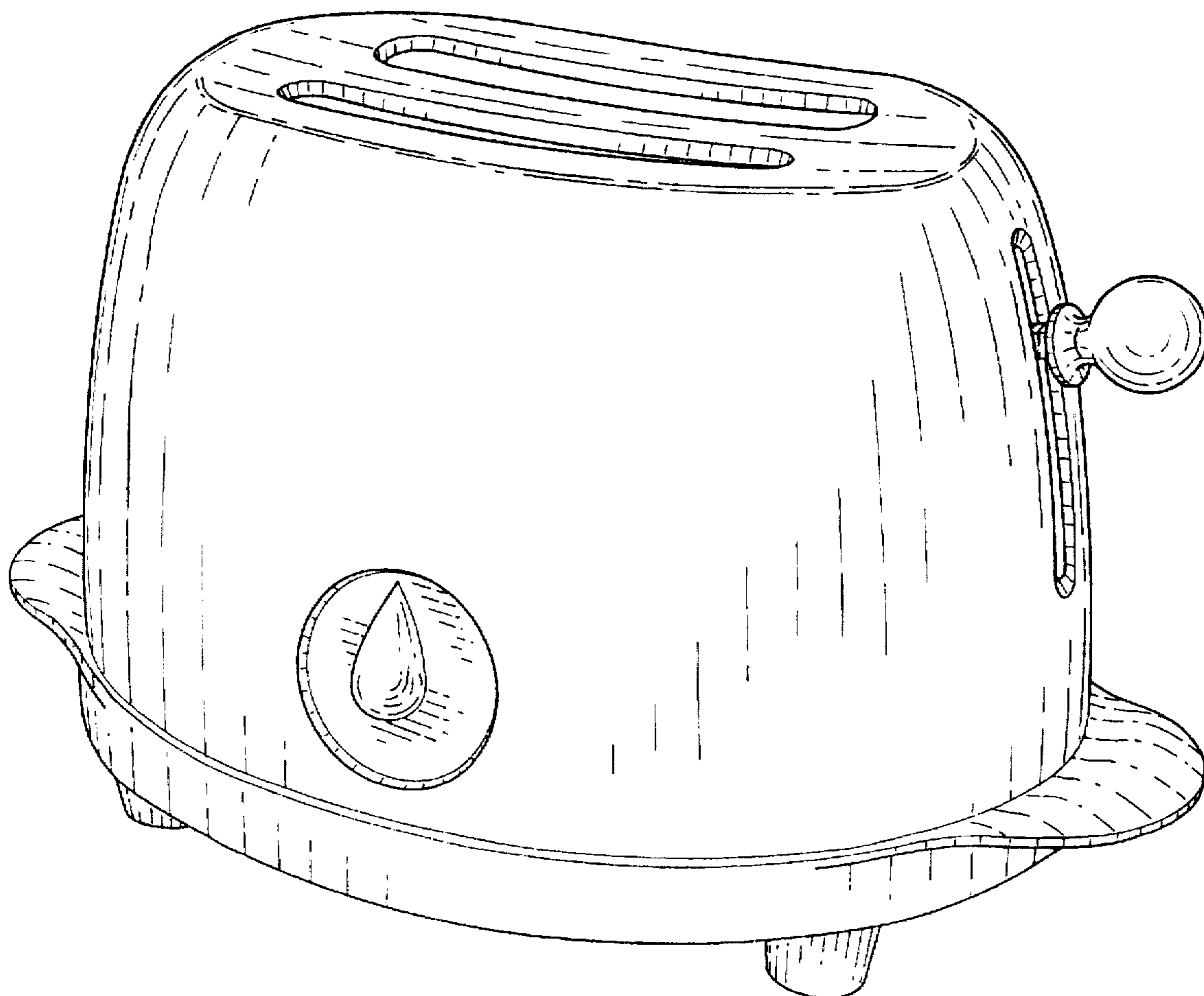

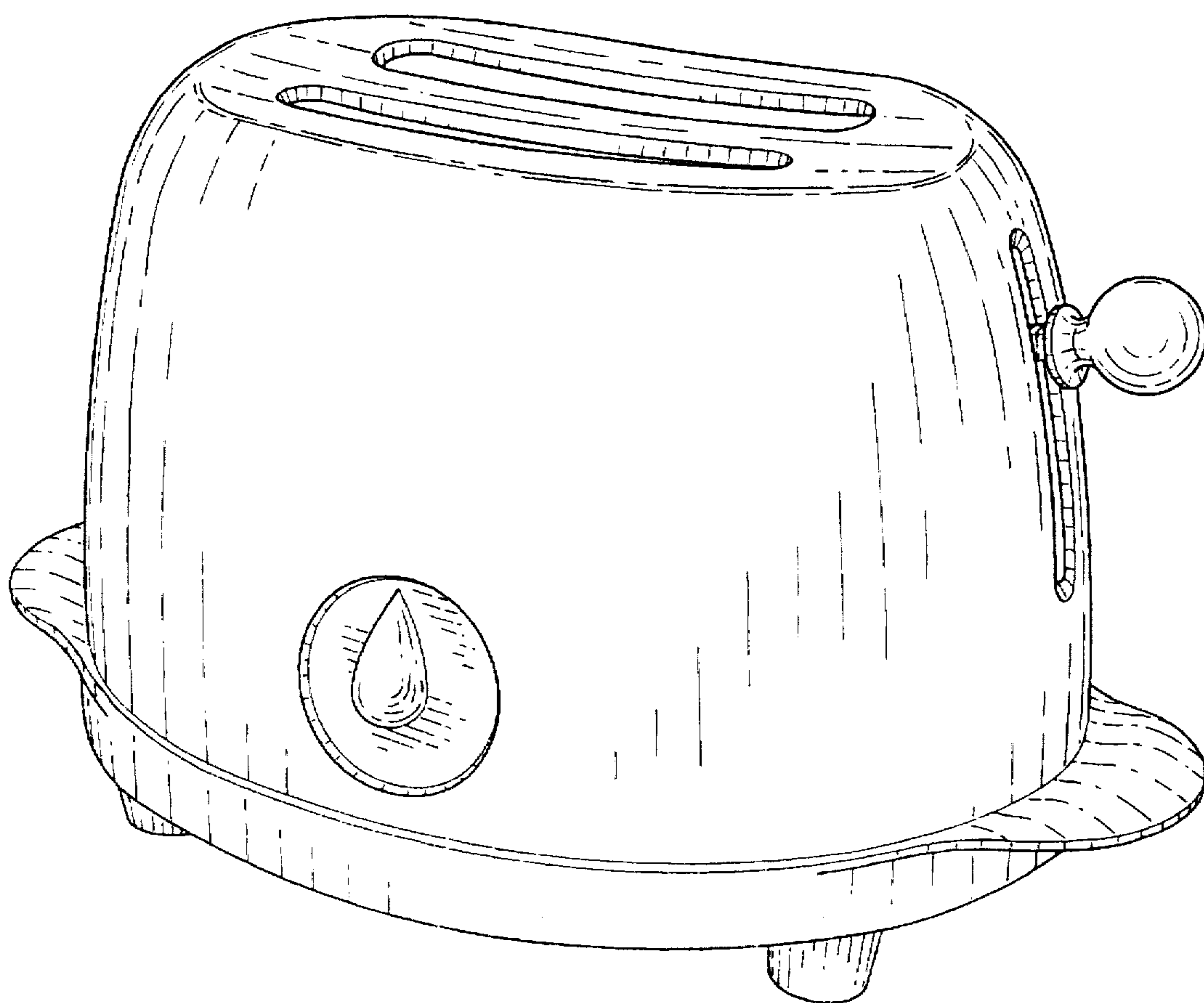

FIG. 1

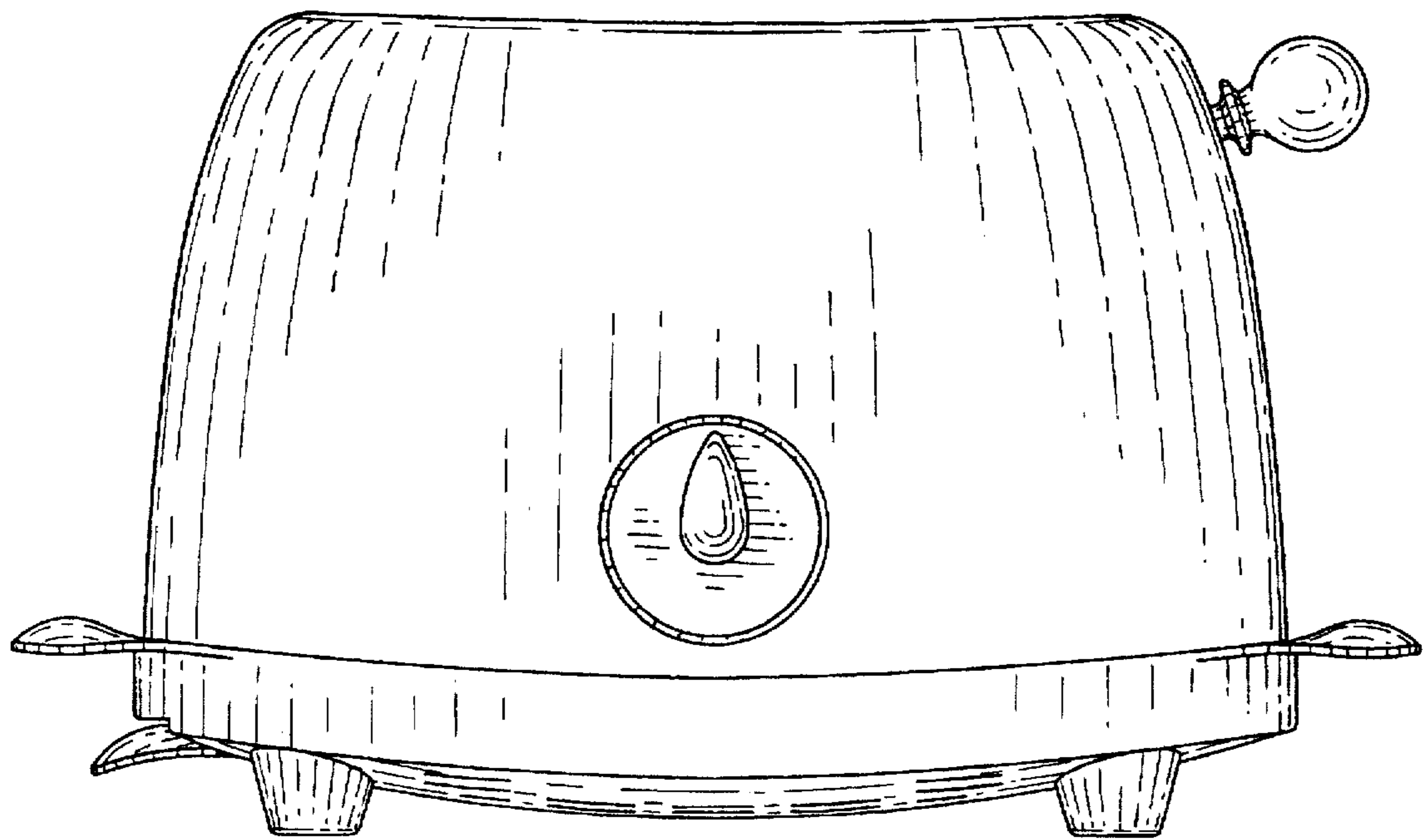

FIG. 2

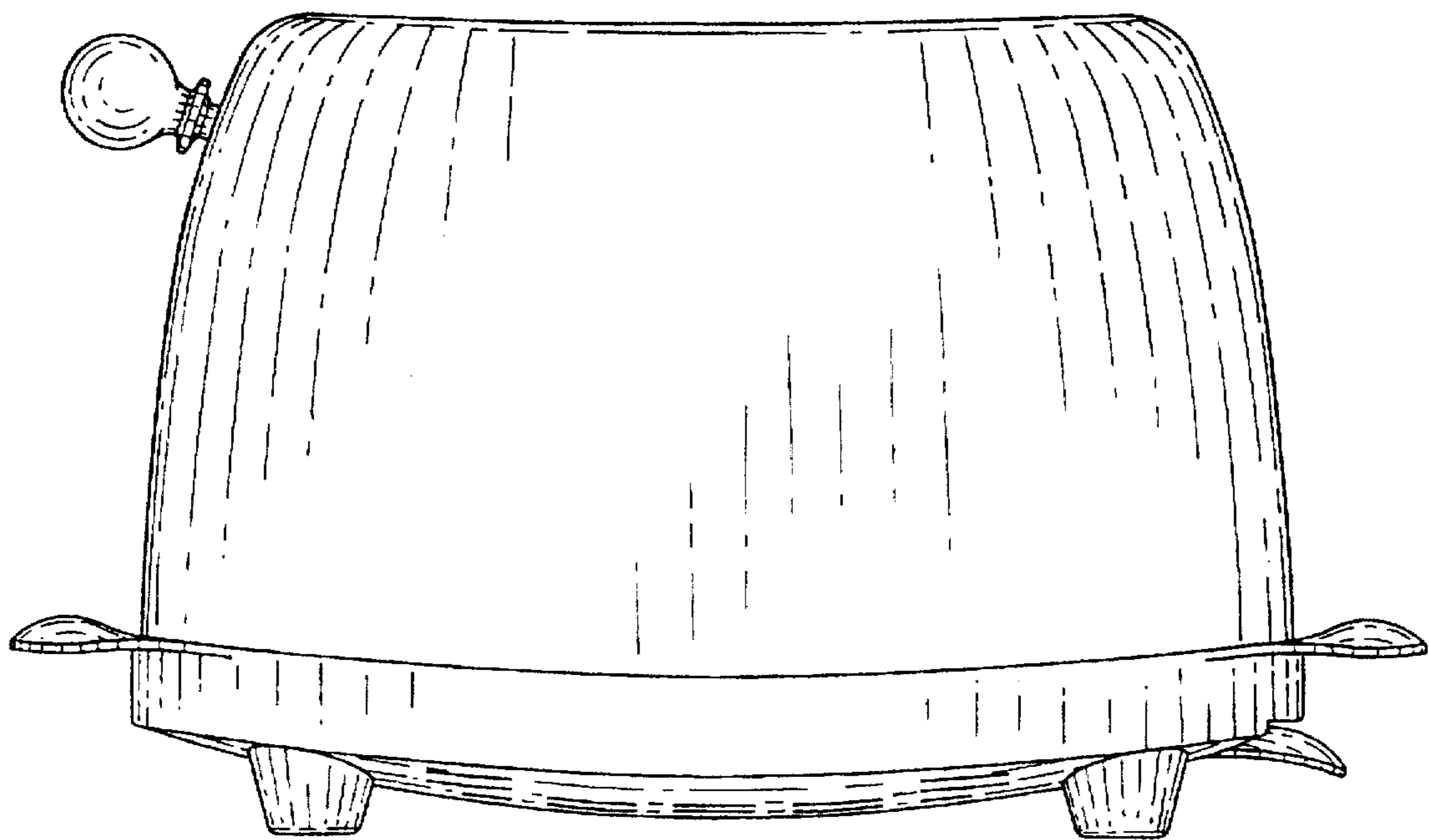

FIG. 3

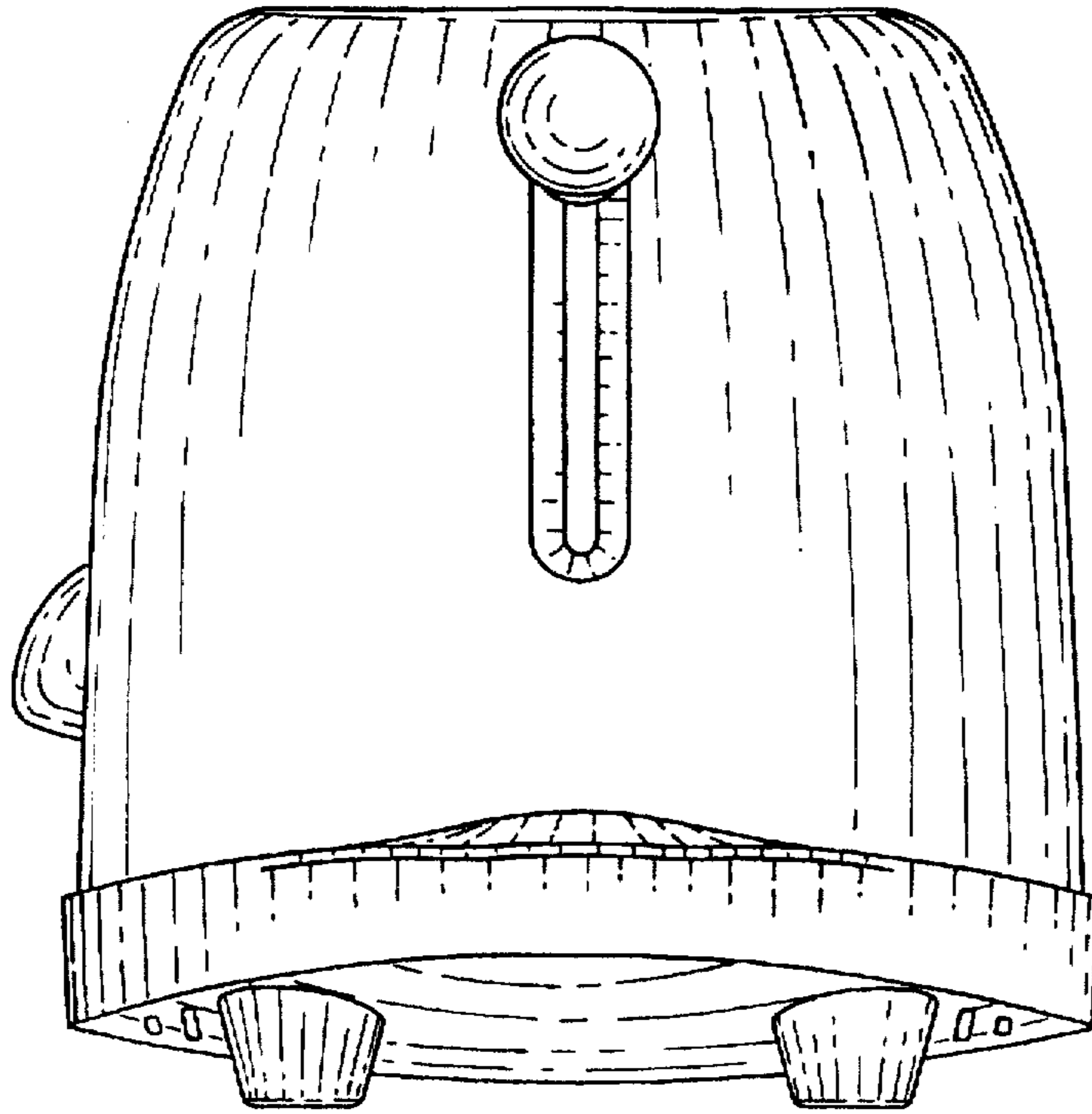

FIG. 4

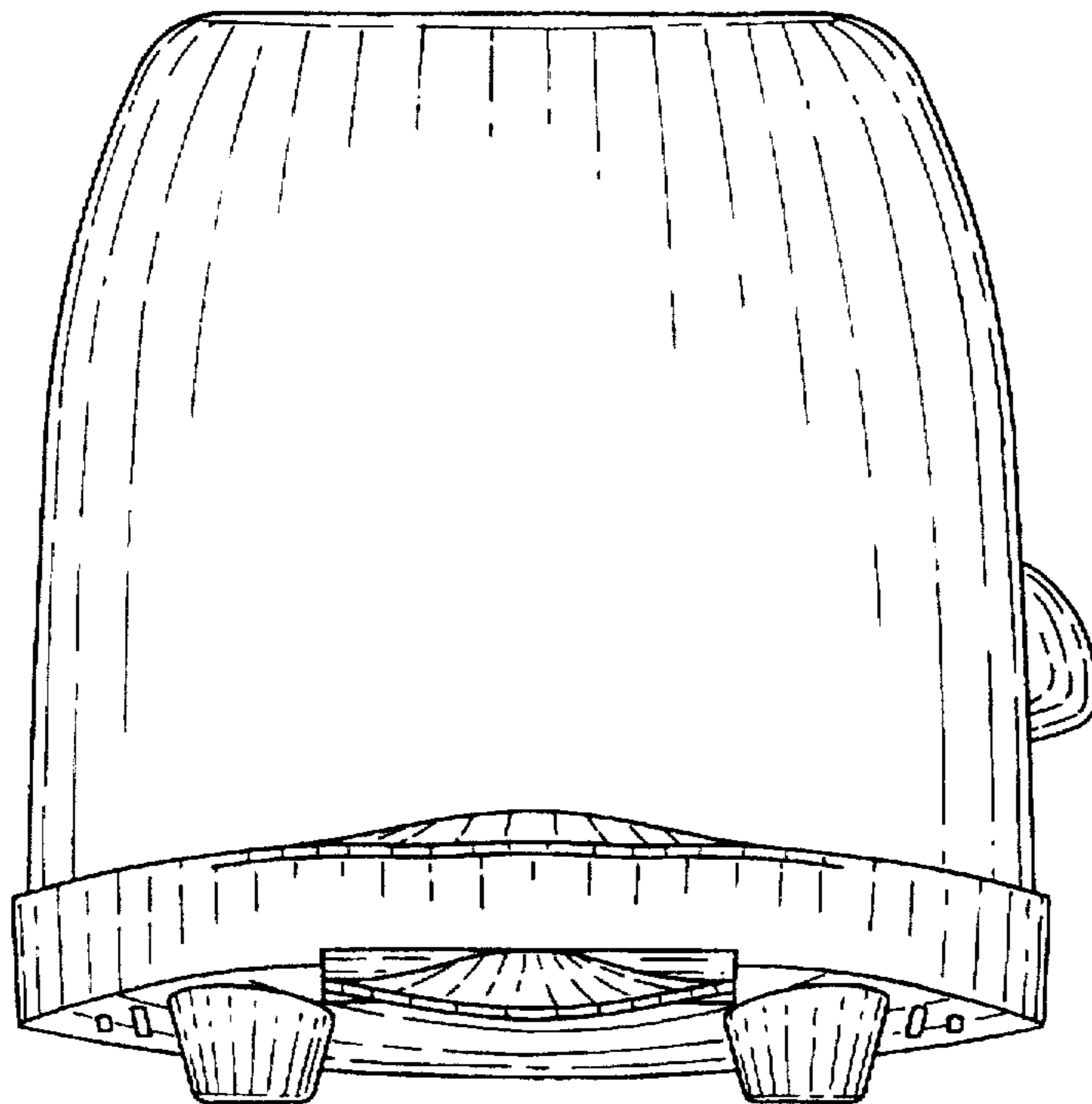

FIG. 5

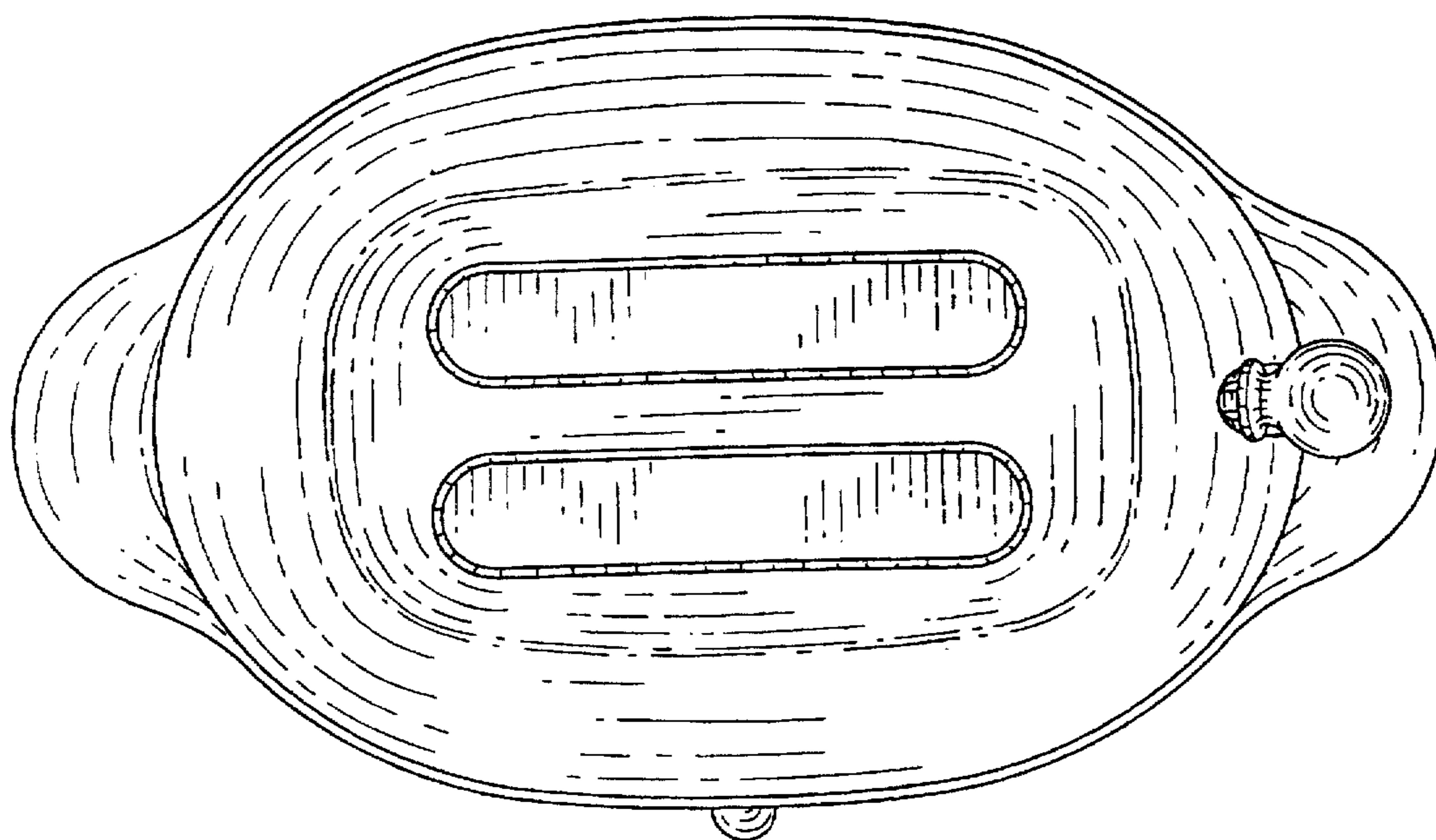

FIG. 6

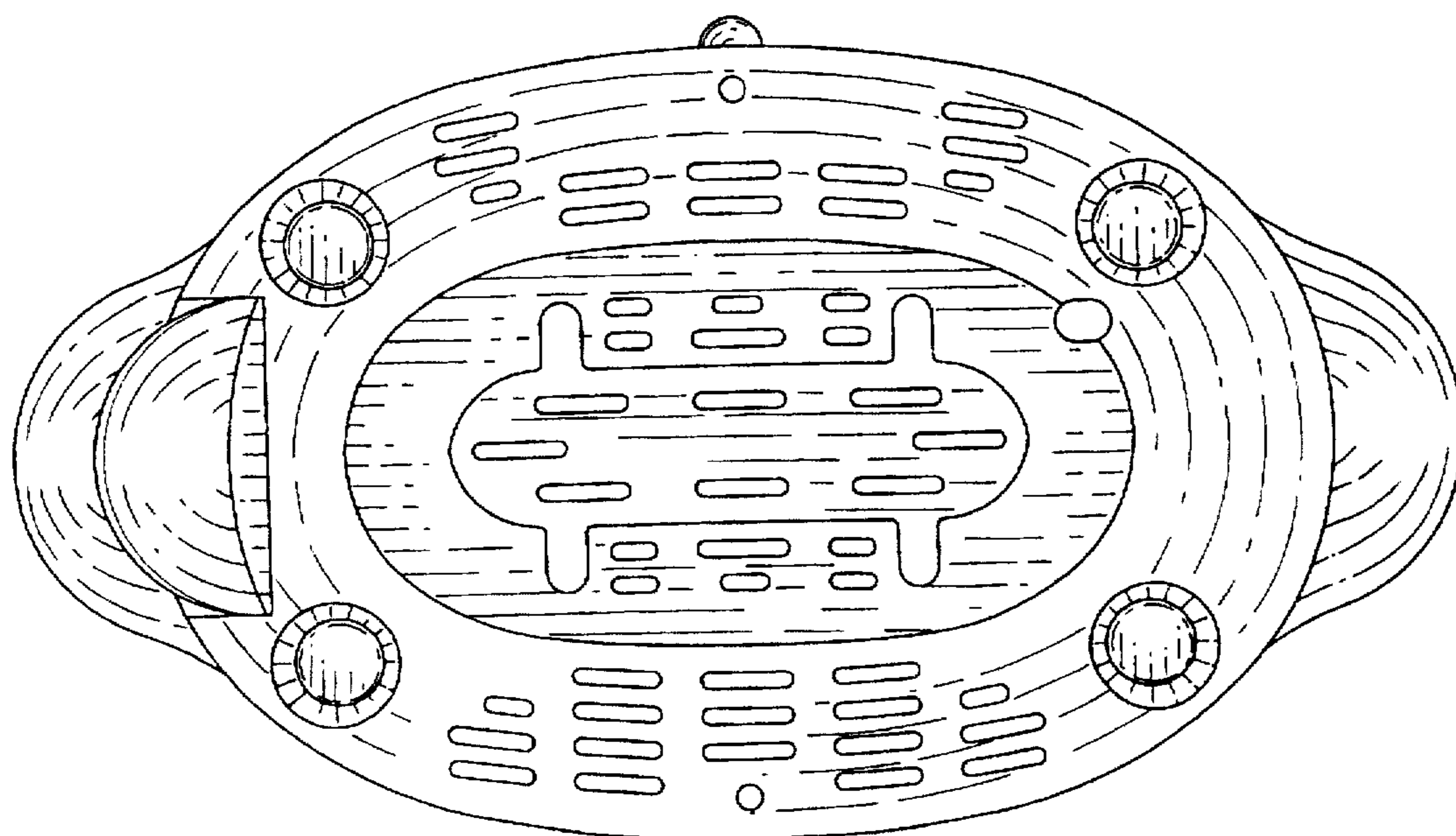

FIG. 7