



US00D396070S

United States Patent [19]

[11] Patent Number: **Des. 396,070**

Katzman et al.

[45] Date of Patent: ****Jul. 14, 1998**

[54] GARDEN PLAYSET WITH PANELS FOR DECORATION

[75] Inventors: **Allison Katzman**, Evanston; **Randall Jon Klimpert**, Wilmette; **Dianne Elizabeth Lauble**, Chicago; **Michael John Lichodziejewski**, Schaumburg; **Craig Dennis Sellers**; **Paula Yurkovic**, both of Chicago, all of Ill.

[73] Assignee: **Meyer/Glass Design, Ltd.**, Chicago, Ill.

[**] Term: **14 Years**

[21] Appl. No.: **73,383**

[22] Filed: **Jul. 11, 1997**

[51] LOC (6) Cl. **21-01**

[52] U.S. Cl. **D21/109; D21/114**

[58] Field of Search **D21/109, 120, D21/121, 122, 123, 114, 59, 240; D6/436, 450; 446/478, 479, 481, 482, 485**

[56] References Cited

U.S. PATENT DOCUMENTS

D. 178,021	6/1956	Stanley	D21/121
D. 247,721	4/1978	Wax	D21/121
D. 293,699	1/1988	Thornell	D21/121
D. 308,896	6/1990	Ng	D21/121
D. 383,328	9/1997	Bro et al.	D21/123
1,647,733	11/1927	Keichline	446/478
5,265,848	11/1993	Michaud et al.	446/478
5,562,520	10/1996	Pridonoff	446/478

Primary Examiner—Raphael Barkai
Attorney, Agent, or Firm—Marc J. Whipple

[57] CLAIM

The ornamental design for a garden playset with panels for decoration, as shown and described.

DESCRIPTION

FIG. 1 is a perspective view of the garden playset with panels for decoration showing our new design; FIG. 2 is a perspective view of the playset of FIG. 1 with backing panels collapsed to show the fold lines;

FIG. 3 is a perspective view of the playset of FIG. 1 showing rotatable features extended and top and front of cabinet opened to reveal interior;

FIG. 4 is a perspective view of the playset of FIG. 1, top and front of cabinet closed, plus snap-on fence and hinged gate piece;

FIG. 5 is a front elevation view of the playset of FIG. 1, detailing left unit, top and front of cabinet closed, rotatable features retracted;

FIG. 6 is a rear elevation view of the playset of FIG. 1, showing the means of attaching the backing panel, rotatable features retracted;

FIG. 7 is a right elevation view of the playset of FIG. 1, detailing left unit, top and front of cabinet closed, rotatable features retracted;

FIG. 8 is a left elevation view of the playset of FIG. 1, detailing left unit, top and front of cabinet closed, rotatable features retracted;

FIG. 9 is a top elevation view of the playset of FIG. 1, detailing left unit, top and front of cabinet closed, rotatable features retracted;

FIG. 10 is a bottom elevation view of the playset of FIG. 1 detailing left unit, top and front of cabinet closed, rotatable features retracted;

FIG. 11 is a front elevation view of the playset of FIG. 1, detailing left unit, top and front of cabinet open, rotatable features extended;

FIG. 12 is a left elevation view of the playset of FIG. 1, detailing left unit, top and front of cabinet open, rotatable features extended;

FIG. 13 is a top elevation view of the playset of FIG. 1, detailing left unit, top and front of cabinet open, rotatable features extended;

FIG. 14 is a front elevation view of the playset of FIG. 1, detailing left unit, top and front of cabinet open, rotatable features retracted, with fence and gate in place;

FIG. 15 is a right elevation view of the playset of FIG. 1, detailing left unit, top and front of cabinet closed, rotatable features retracted, with fence and gate in place; and,

FIG. 16 is a top elevation view of the playset of FIG. 1, detailing left unit, top and front of cabinet closed, rotatable features retracted, with fence and gate in place.

The snap-on fence and hinged gate are shown only in FIG. 4, 14, 15 and 16 for ease of illustration only.

1 Claim, 3 Drawing Sheets

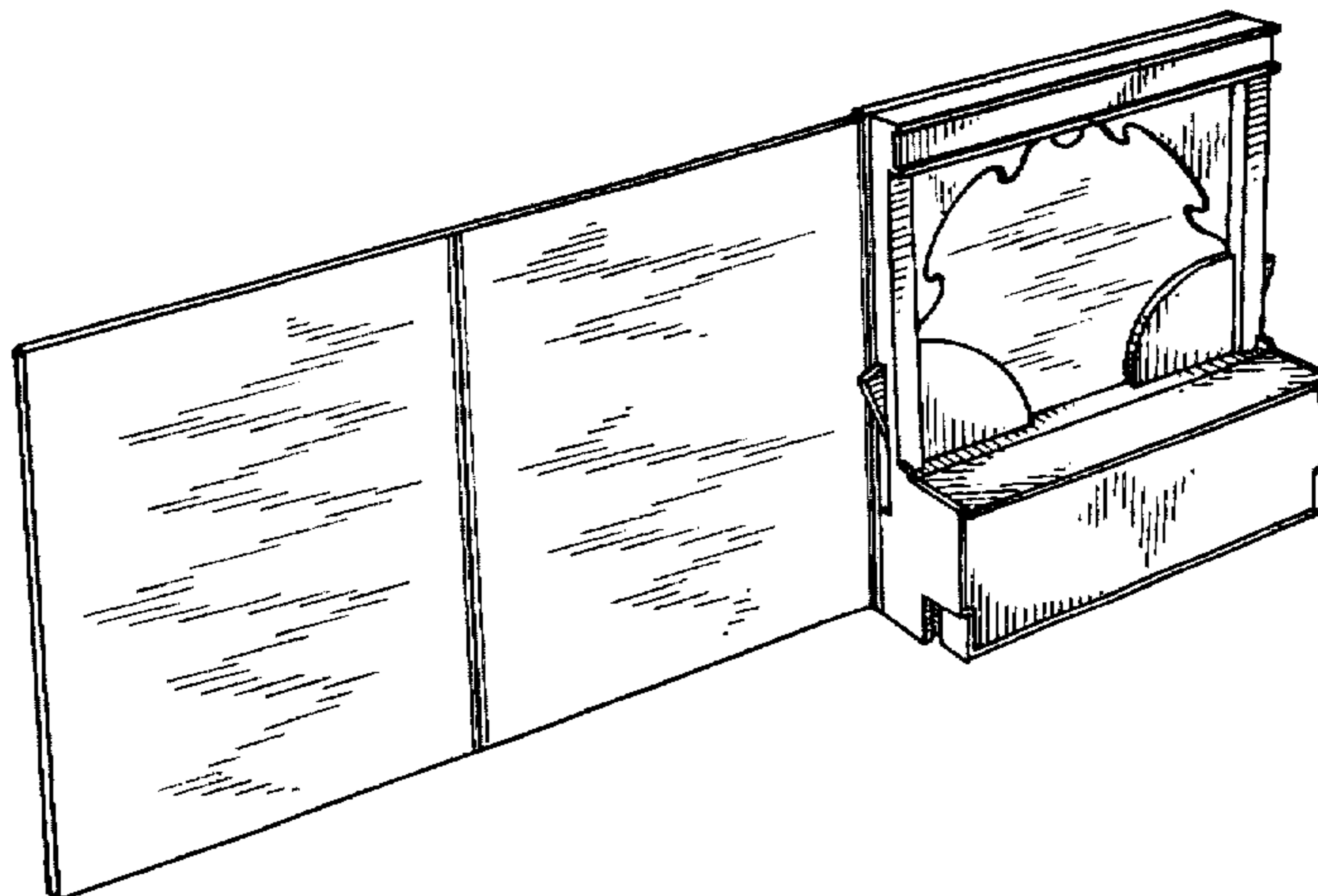

Fig 1

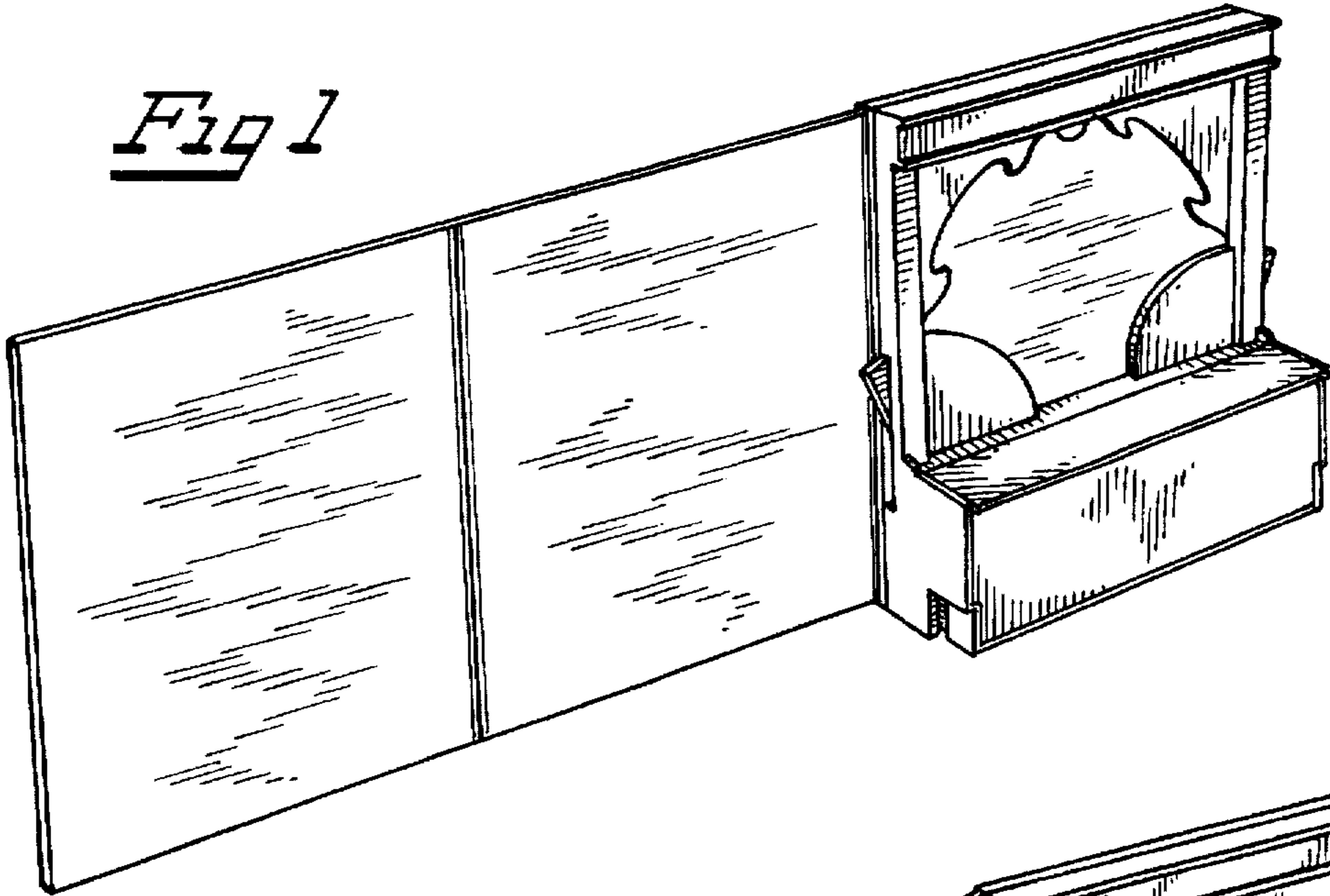

Fig 2

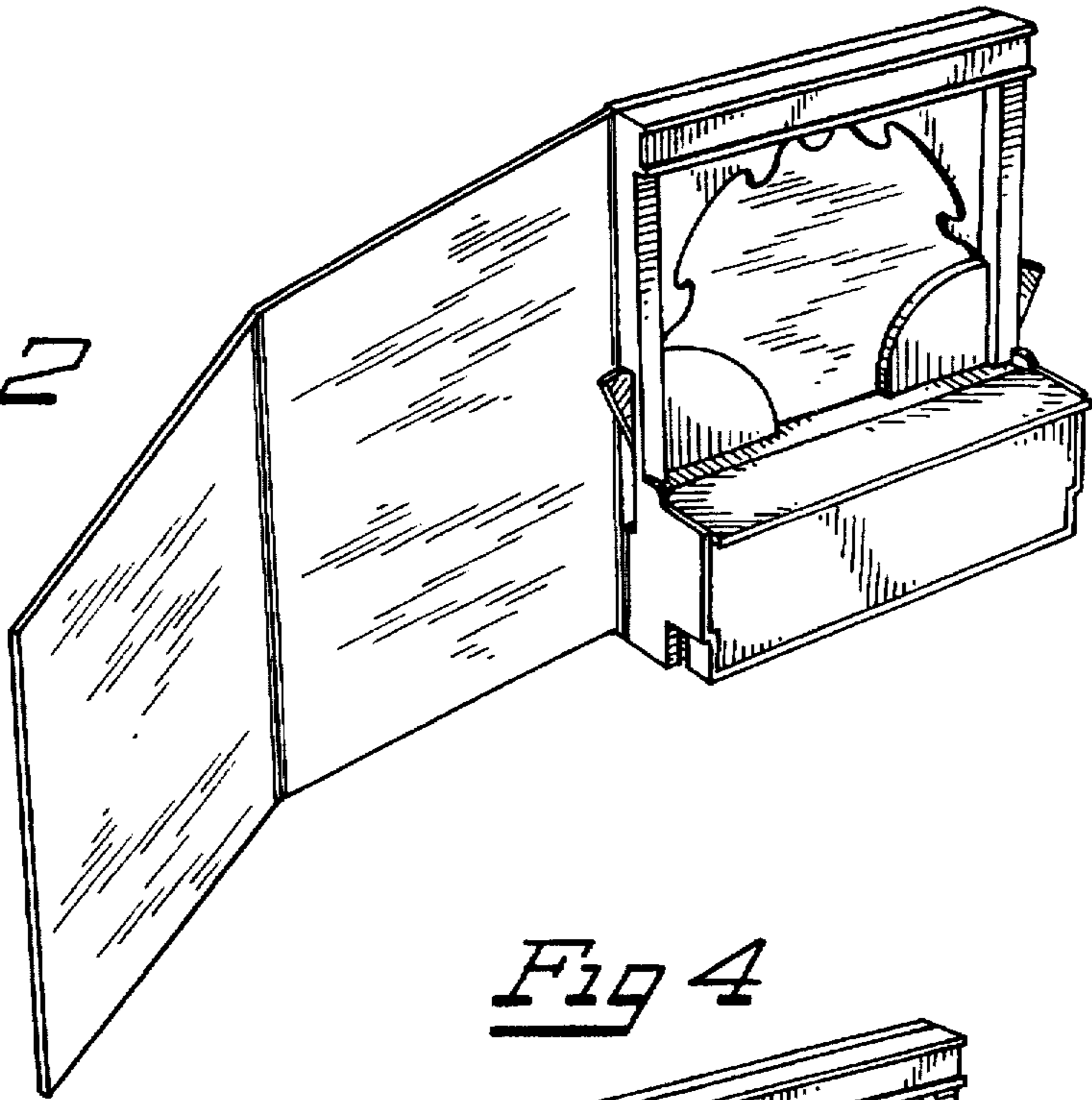

Fig 3

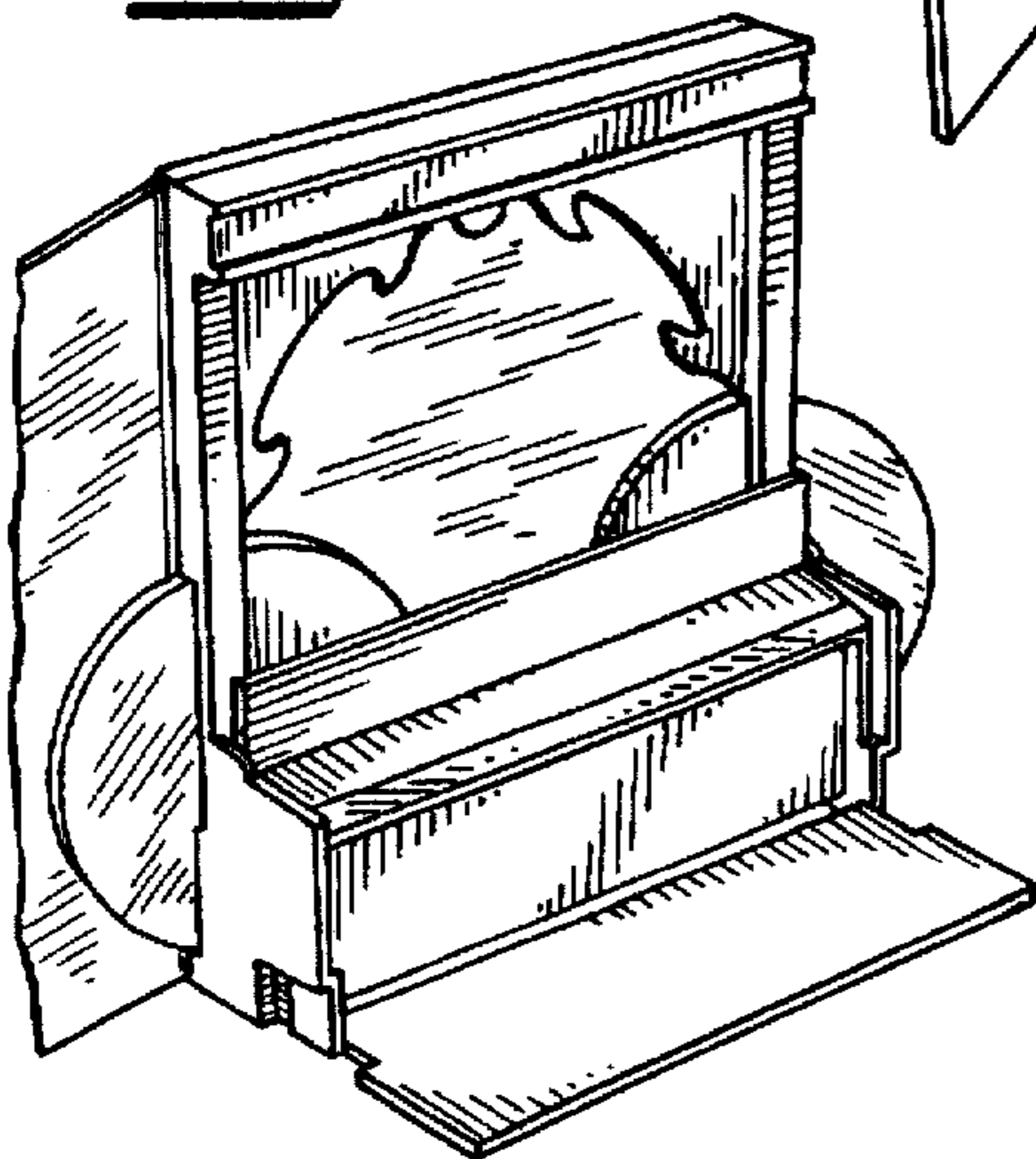

Fig 4

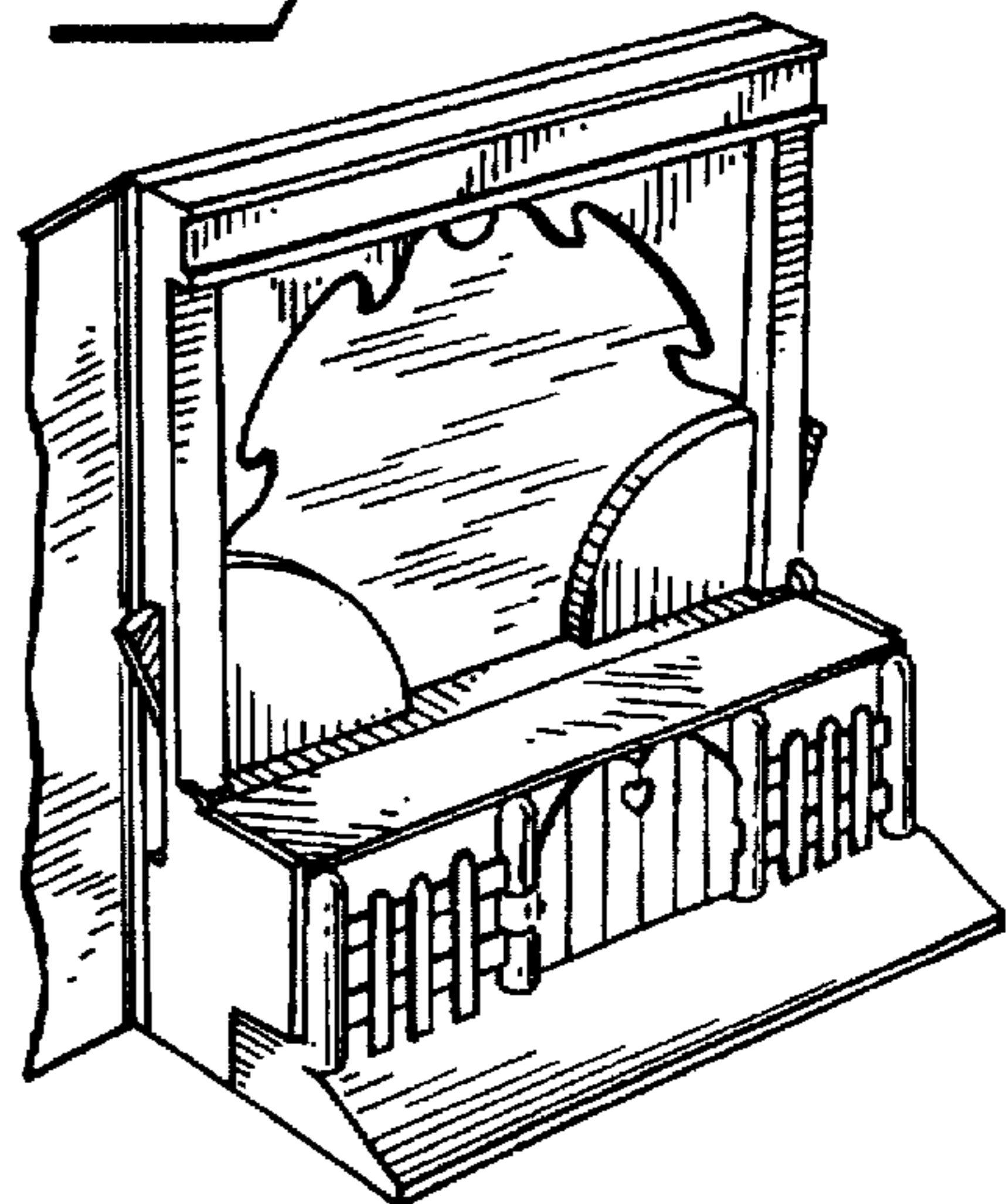

Fig 5



Fig 7

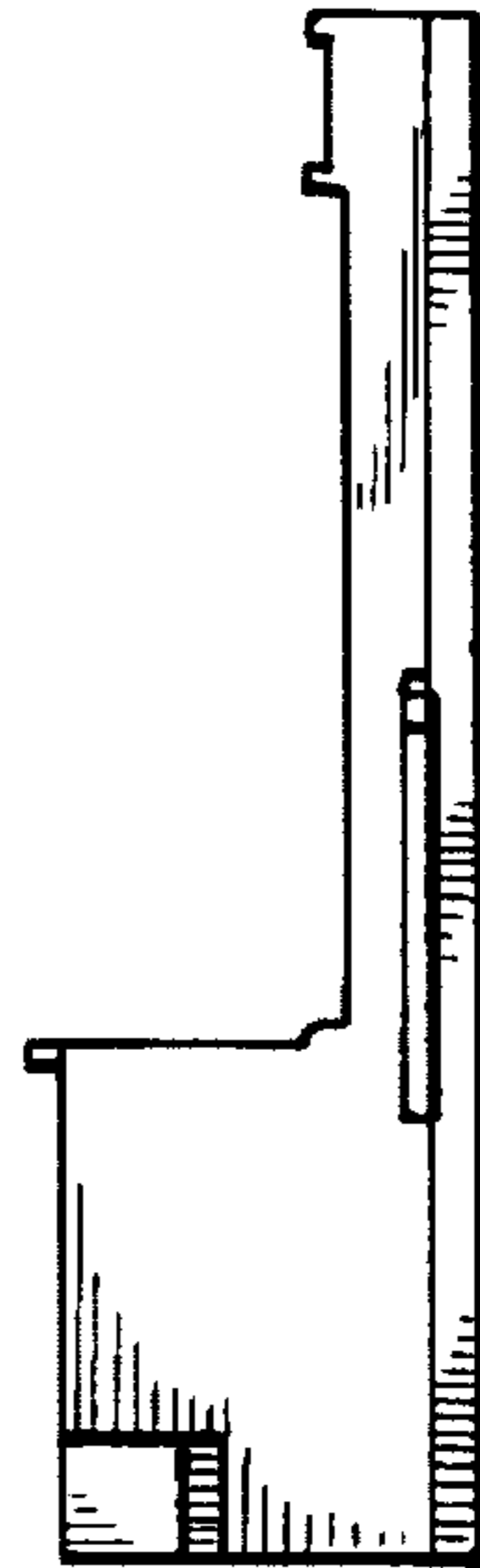

Fig 6

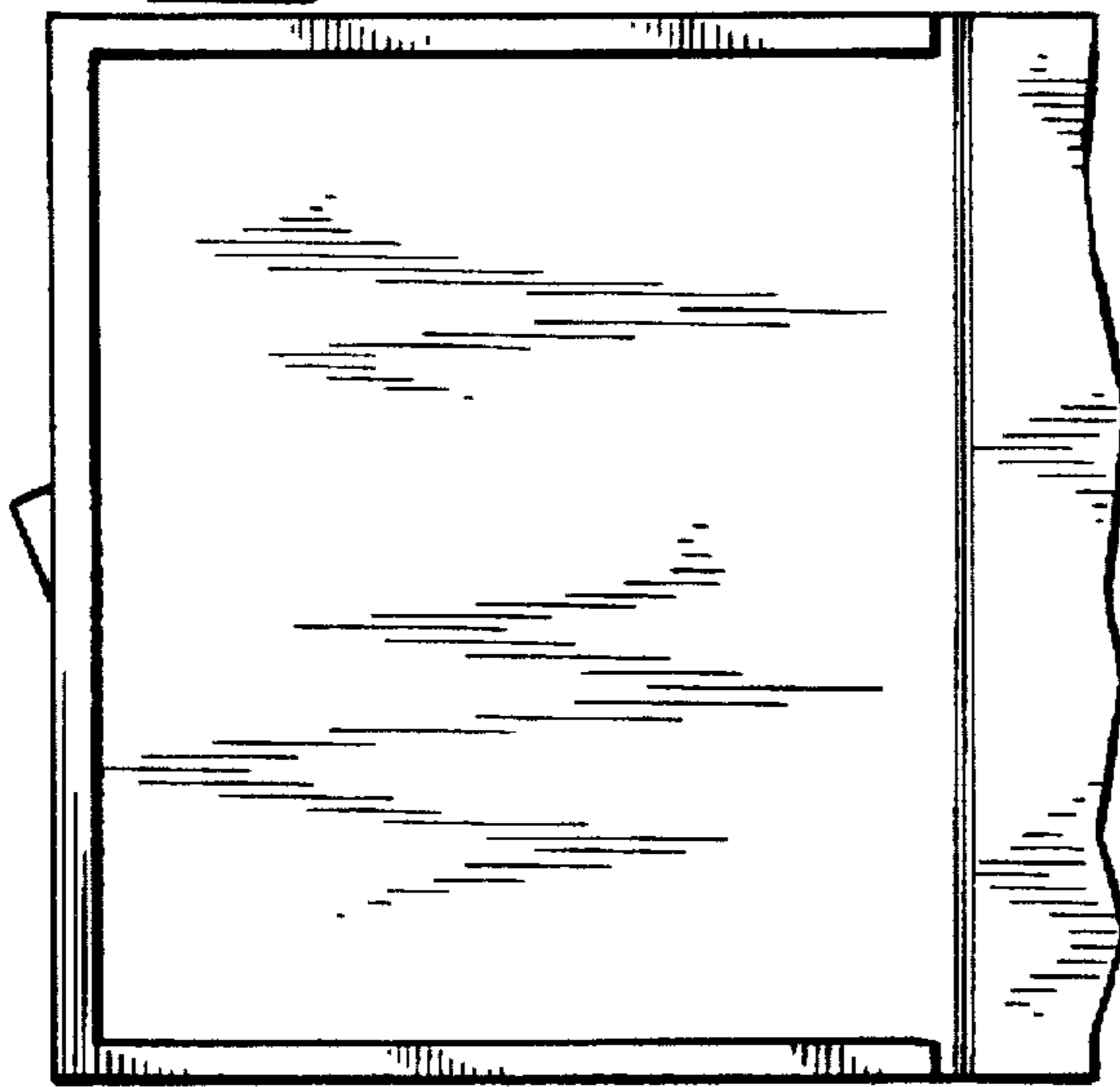

Fig 8

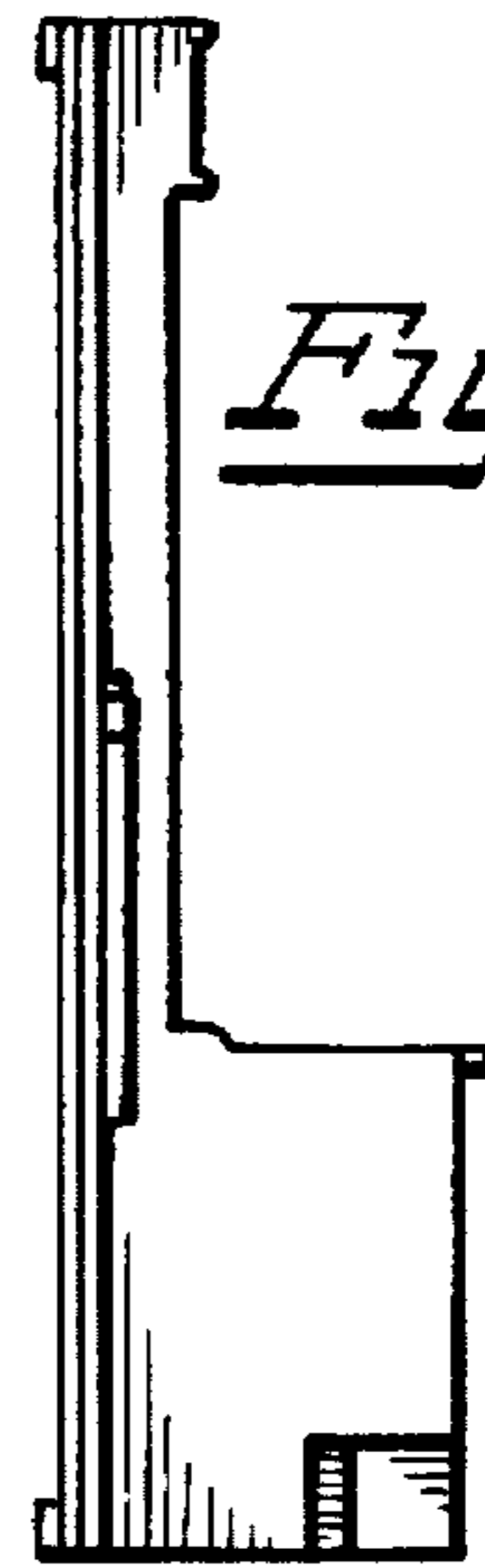

Fig 9

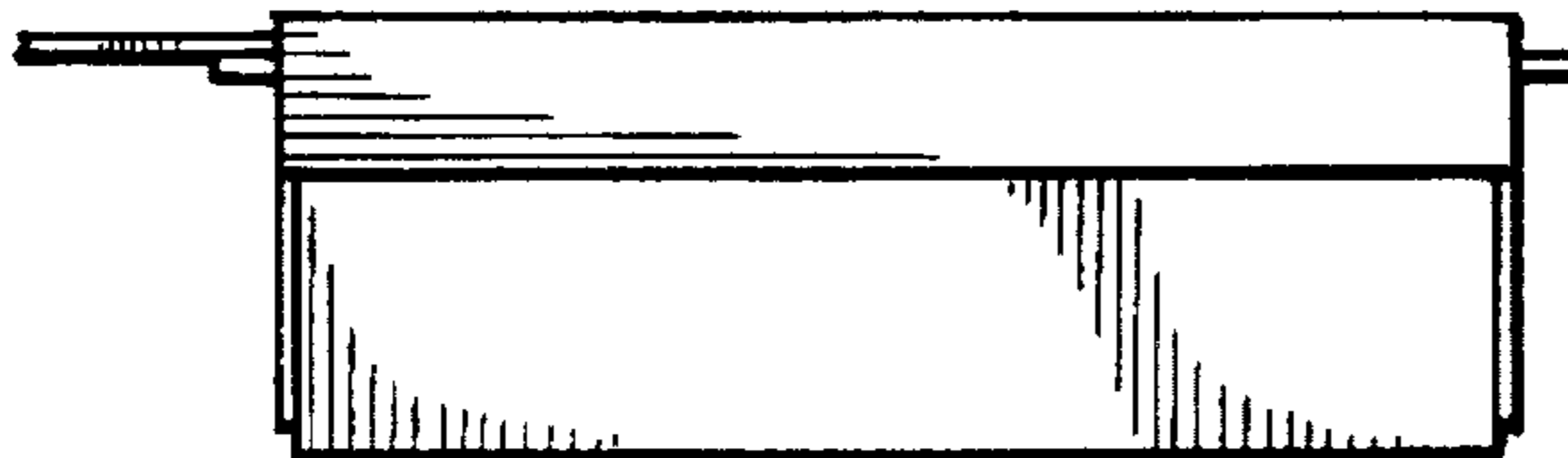

Fig 10

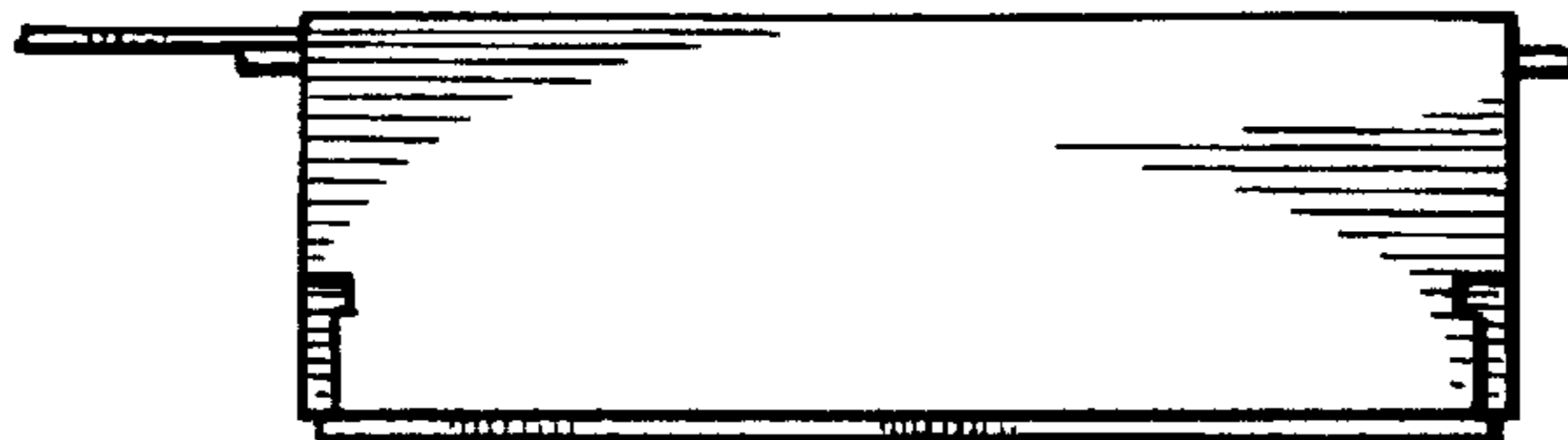

Fig 11

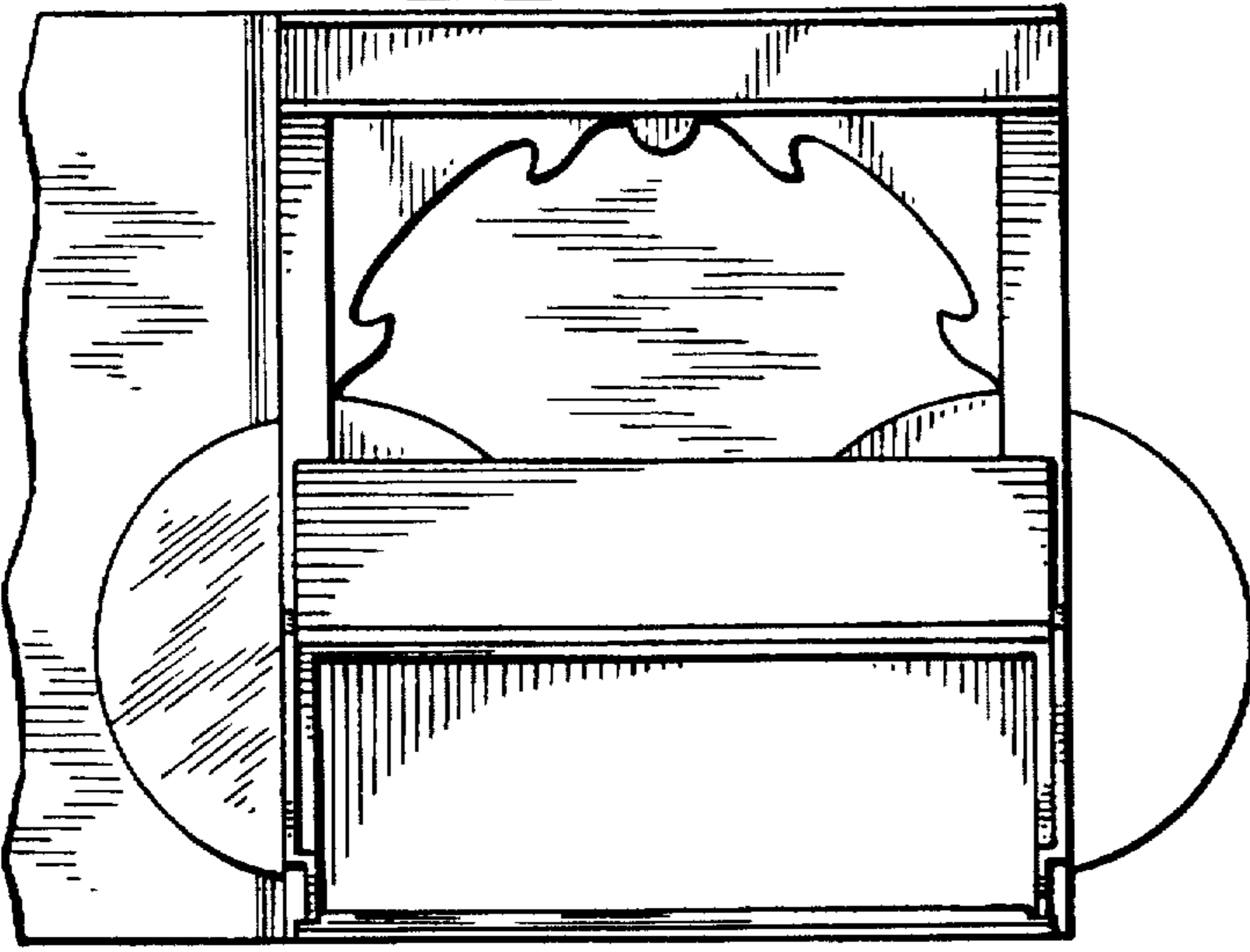

Fig 12

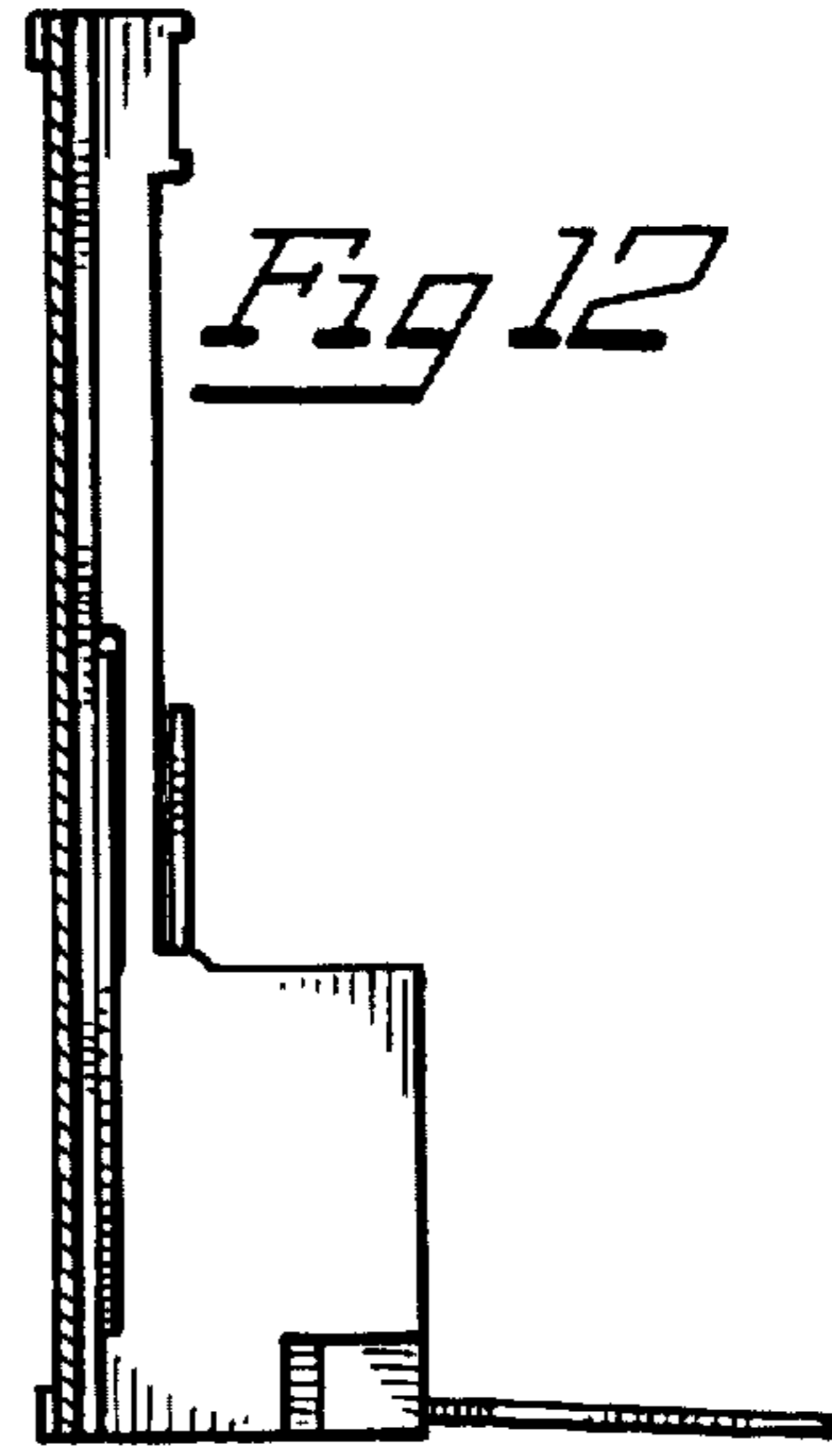

Fig 13

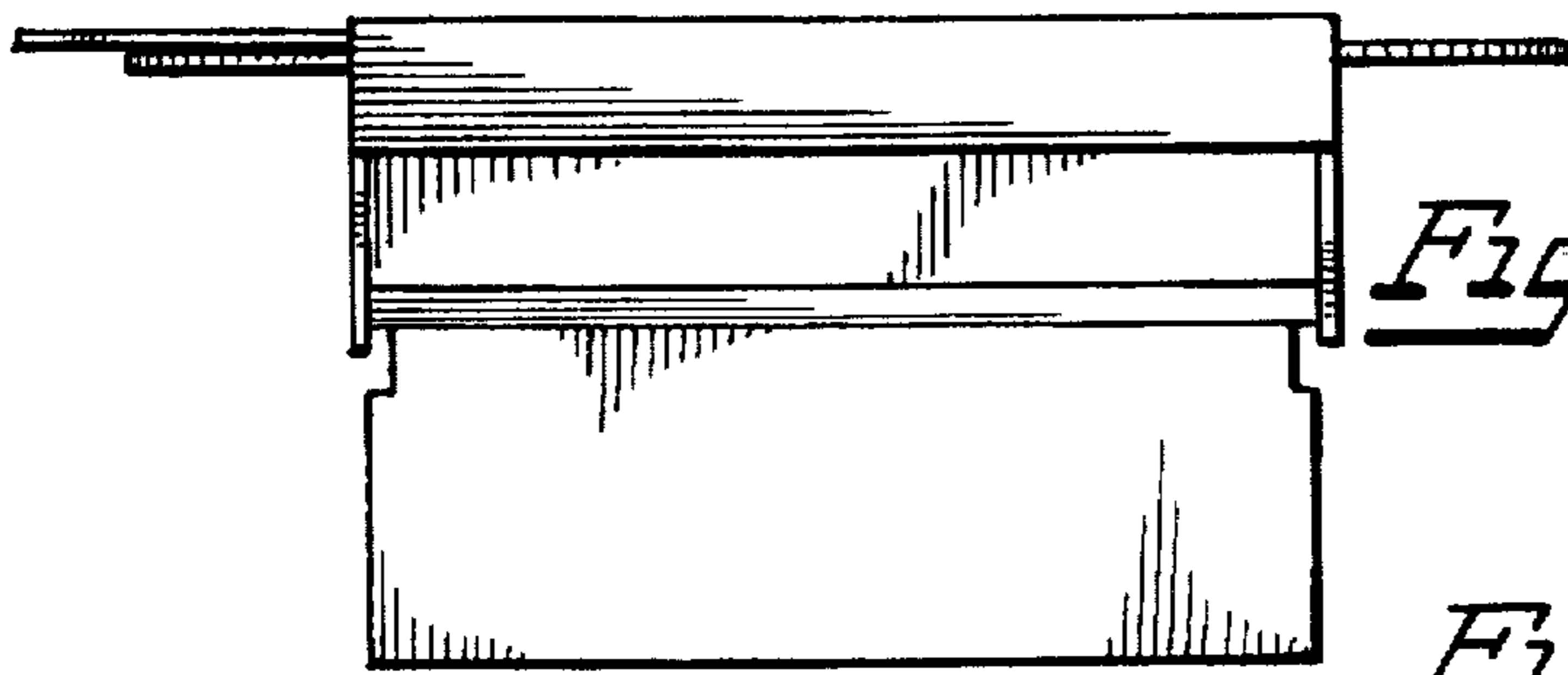

Fig 14

Fig 15

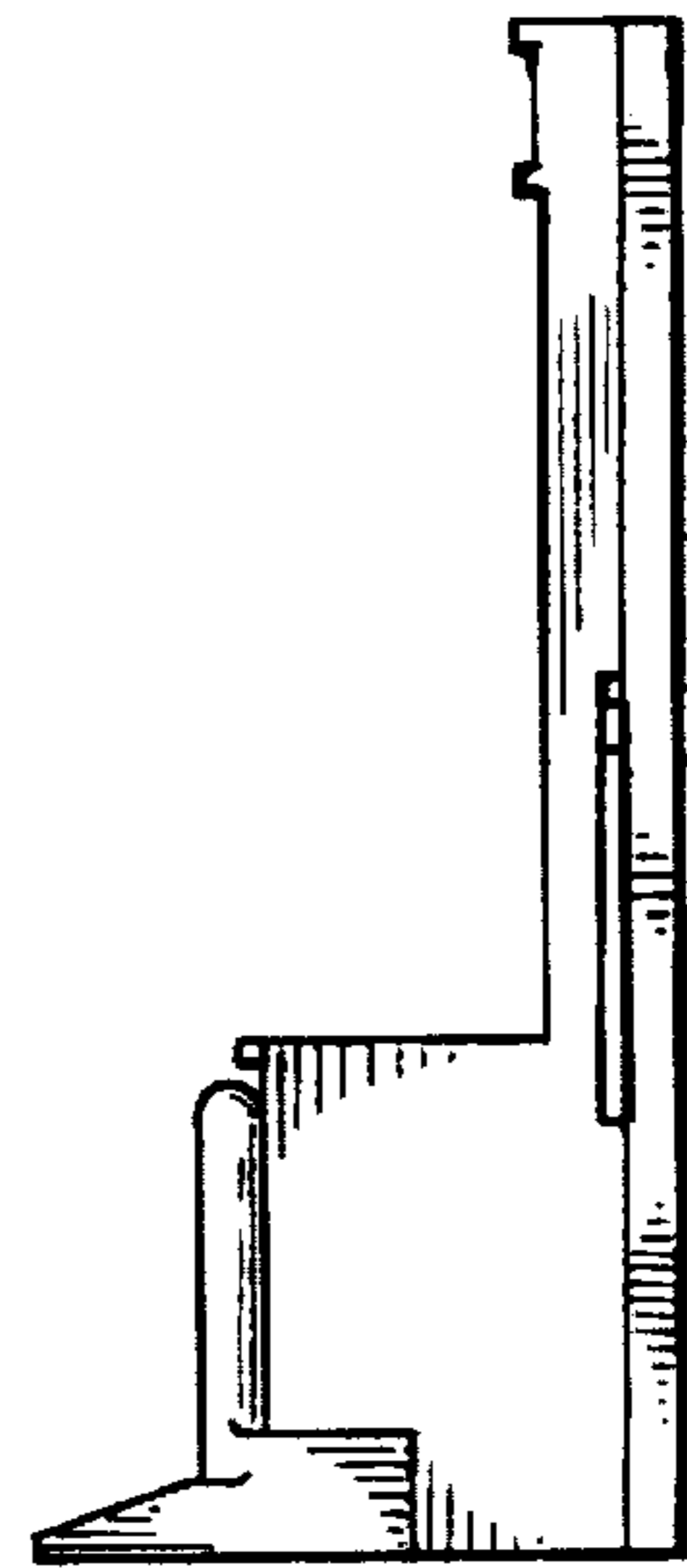
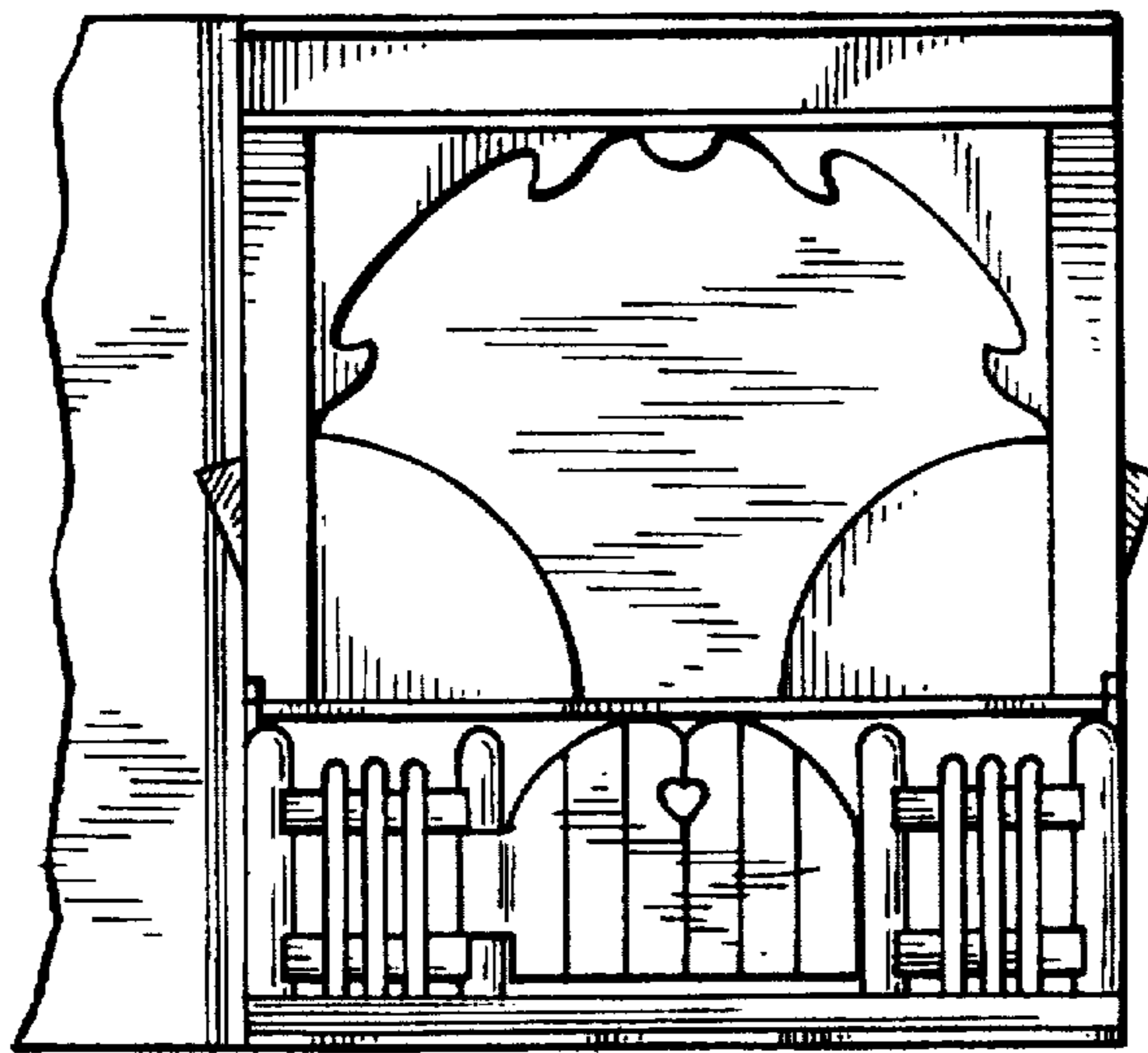

Fig 16

