



US00D396059S

United States Patent [19]

Plantz et al.

[11] Patent Number: **Des. 396,059**

[45] Date of Patent: ****Jul. 14, 1998**

[54] **PEN AND PENCIL CUSHION**
[75] Inventors: **Jeffrey S. Plantz**, Seven Hills;
Nicholas E. Stanca, Westlake, both of
Ohio

1,879,456	9/1932	Parsons	434/166
4,167,347	9/1979	Hoyle	401/88
4,526,547	7/1985	Rusk	401/6 X
4,689,020	8/1987	Rusk	434/166
4,832,604	5/1989	Rusk	401/6 X
5,143,463	9/1992	Pozil et al.	434/166 X

[73] Assignee: **Magic American Corporation**,
Cleveland, Ohio

Primary Examiner—Martie Thompson
Attorney, Agent, or Firm—Benesch, Friedlander, Coplan &
Aronoff LLP

[**] Term: **14 Years**

[21] Appl. No.: **75,018**

[57] CLAIM

[22] Filed: **Aug. 11, 1997**

The ornamental design for a pen and pencil cushion, as shown and described.

[51] LOC (6) Cl. **19-06**

DESCRIPTION

[52] U.S. Cl. **D19/55; D19/54**

[58] Field of Search D19/54, 55, 81-85,
D19/56, 57, 58, 65, 99, 100; 401/6, 7, 8,
88; 434/166

FIG. 1 is a front perspective view of the pen and pencil cushion, showing our new design;
FIG. 2 is a rear perspective view thereof;
FIG. 3 is a top plan view thereof;
FIG. 4 is a side elevational view, the opposite side being a mirror image thereof;
FIG. 5 is a bottom view thereof;
FIG. 6 is a front elevational view, the rear view being a mirror image thereof; and,
FIG. 7 is a front perspective view, the pencil depicted by means of broken lines being shown for illustrative purposes only and forming no part of the claimed design.

[56] References Cited

U.S. PATENT DOCUMENTS

D. 189,170	11/1960	Lovejoy	D19/55
D. 191,555	10/1961	Parker	D19/55
D. 298,439	11/1988	Rusk	D19/55
D. 307,919	5/1990	Poisson et al.	D19/41 X
D. 318,295	7/1991	Sze	D19/65 X
D. 328,759	8/1992	Pozil et al.	D19/55
D. 373,143	8/1996	Jagger	D19/54 X

1 Claim, 3 Drawing Sheets

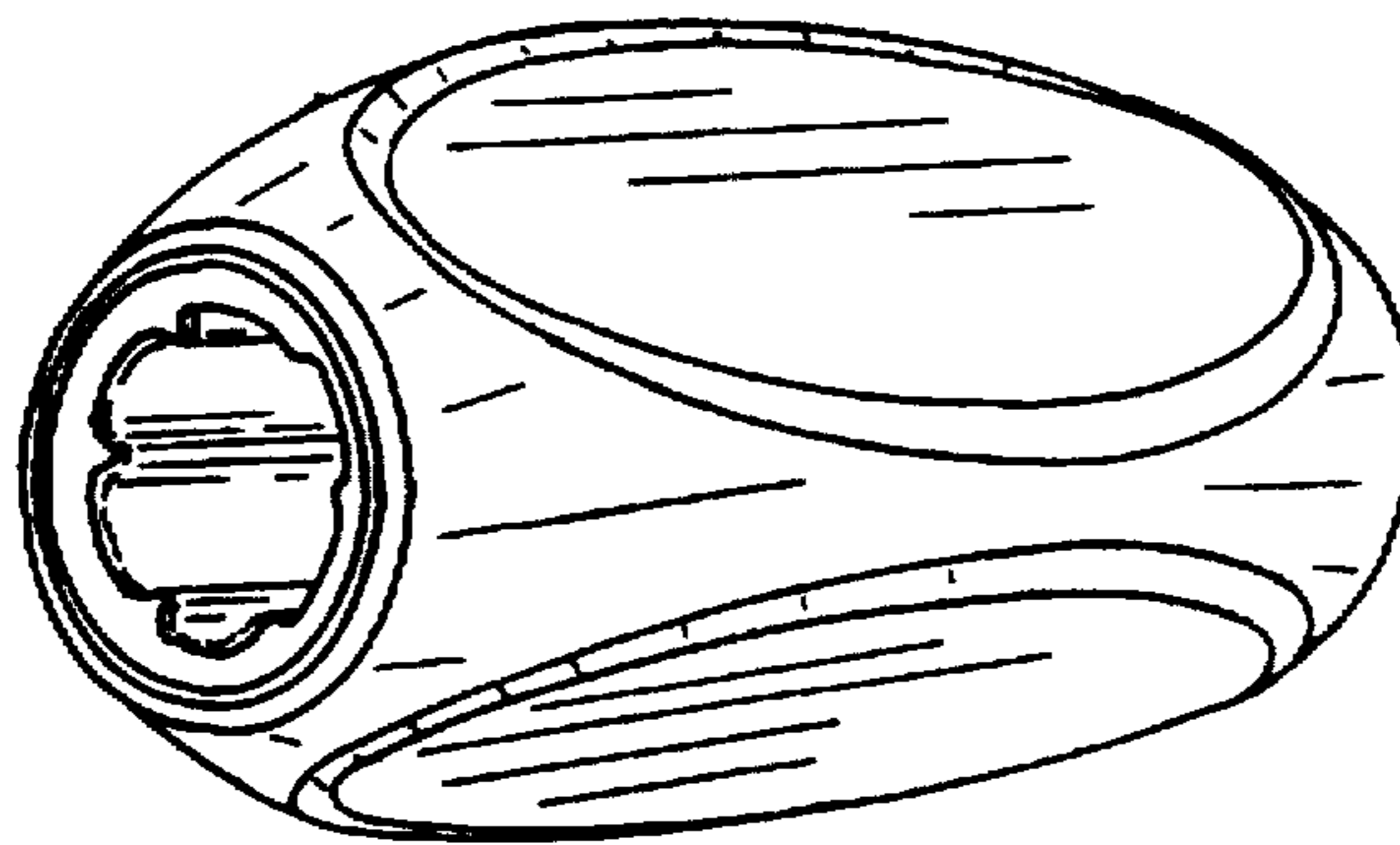

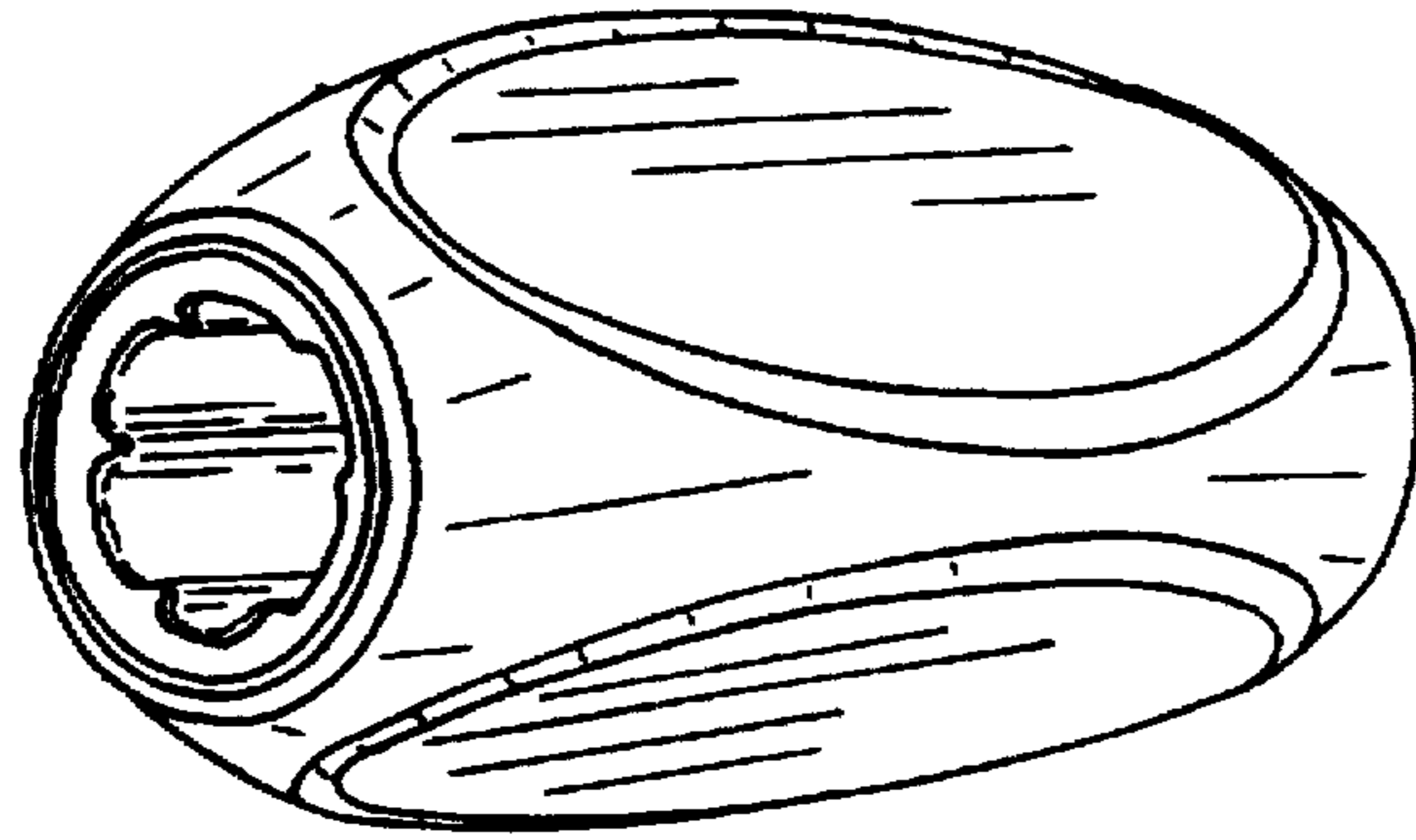

FIG. 1

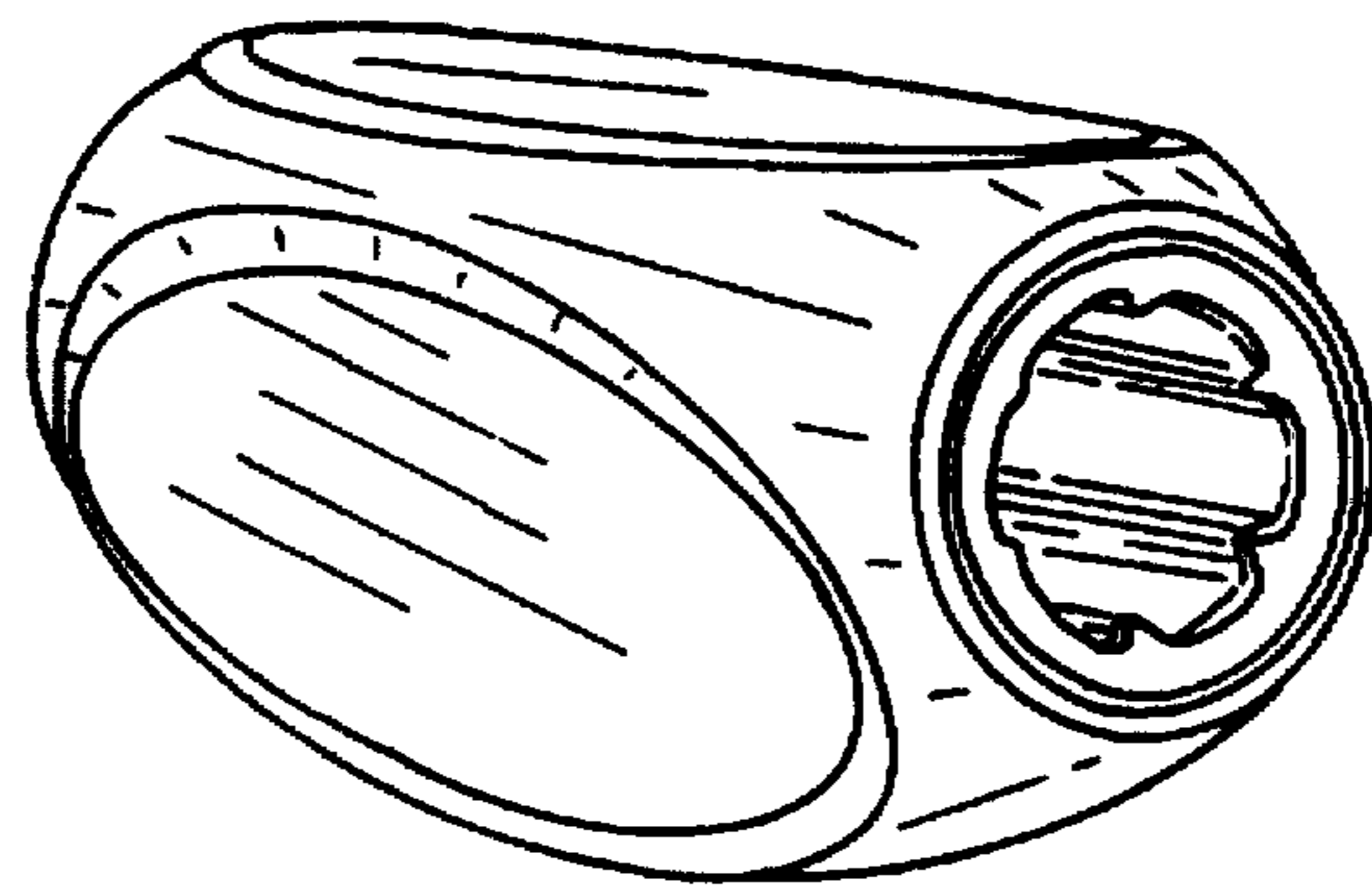

FIG. 2

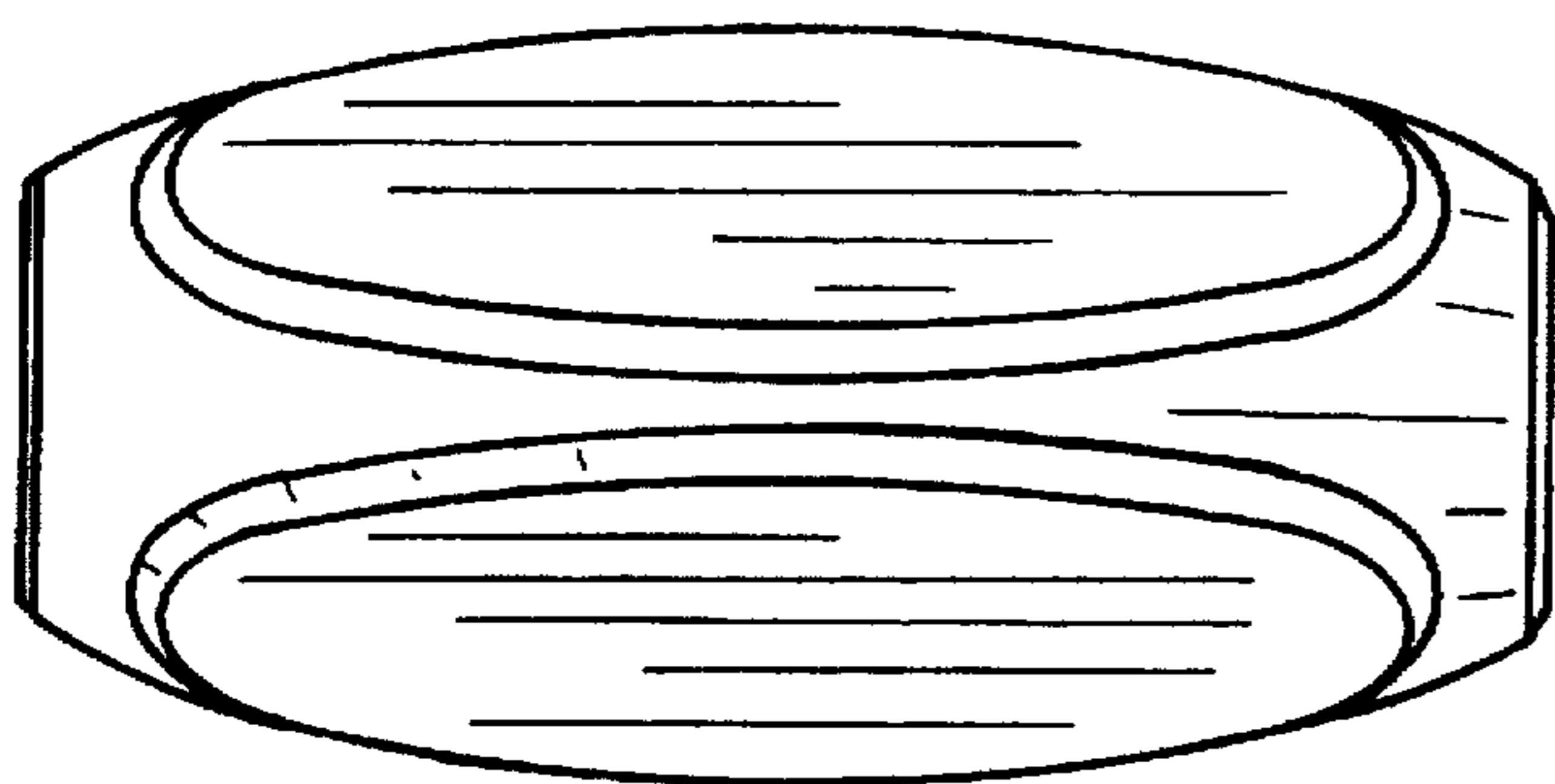

FIG. 3

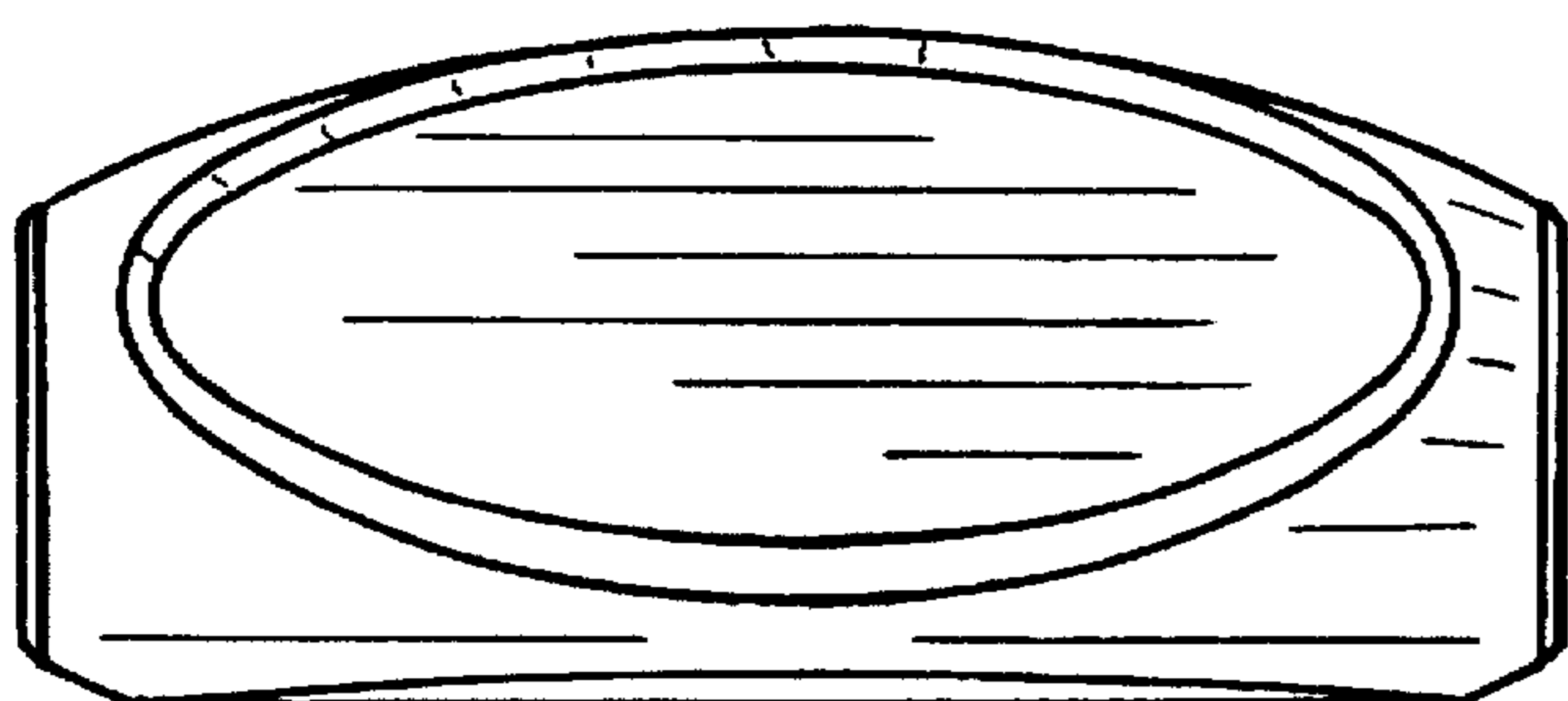

FIG. 4

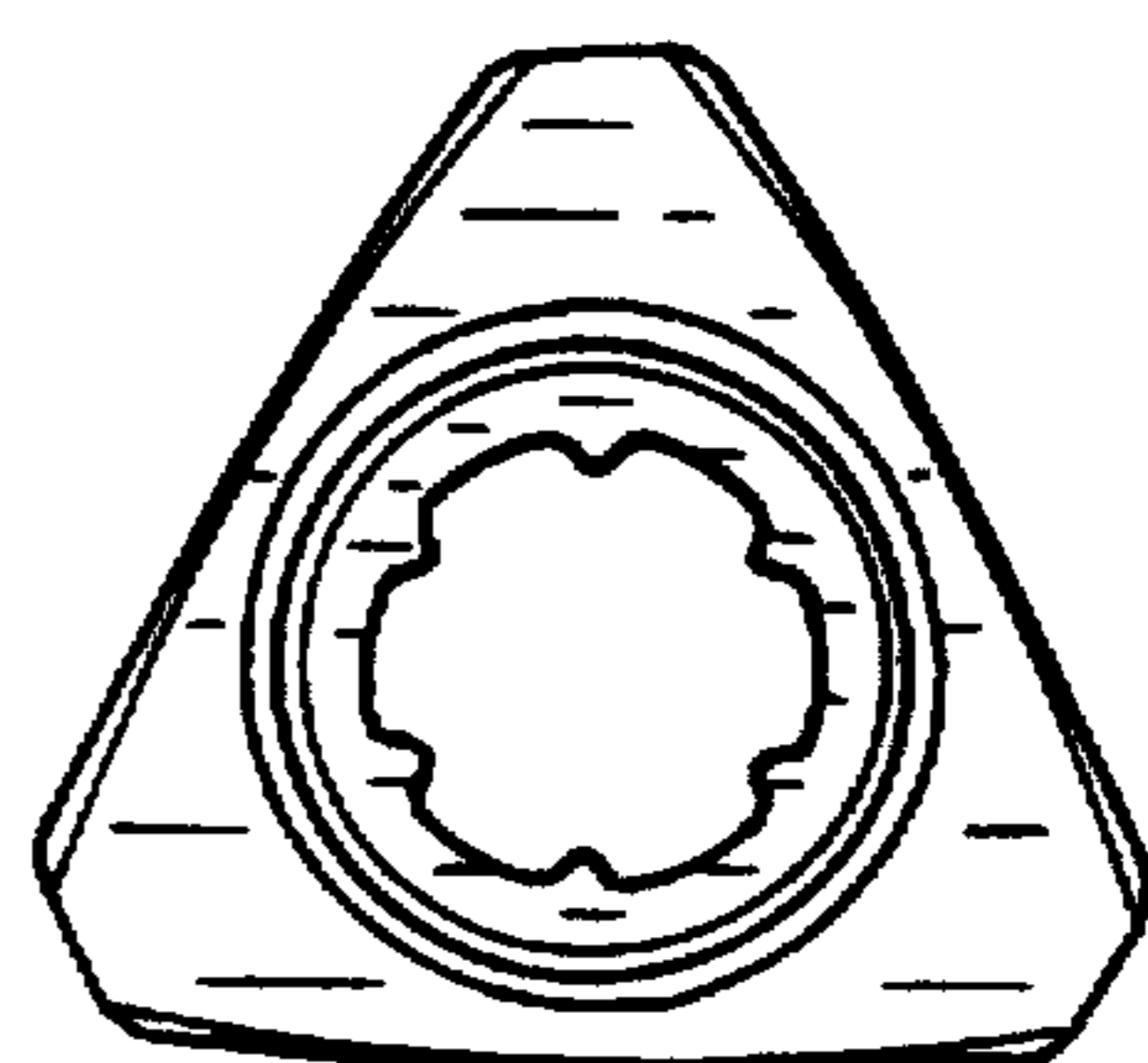

FIG. 6

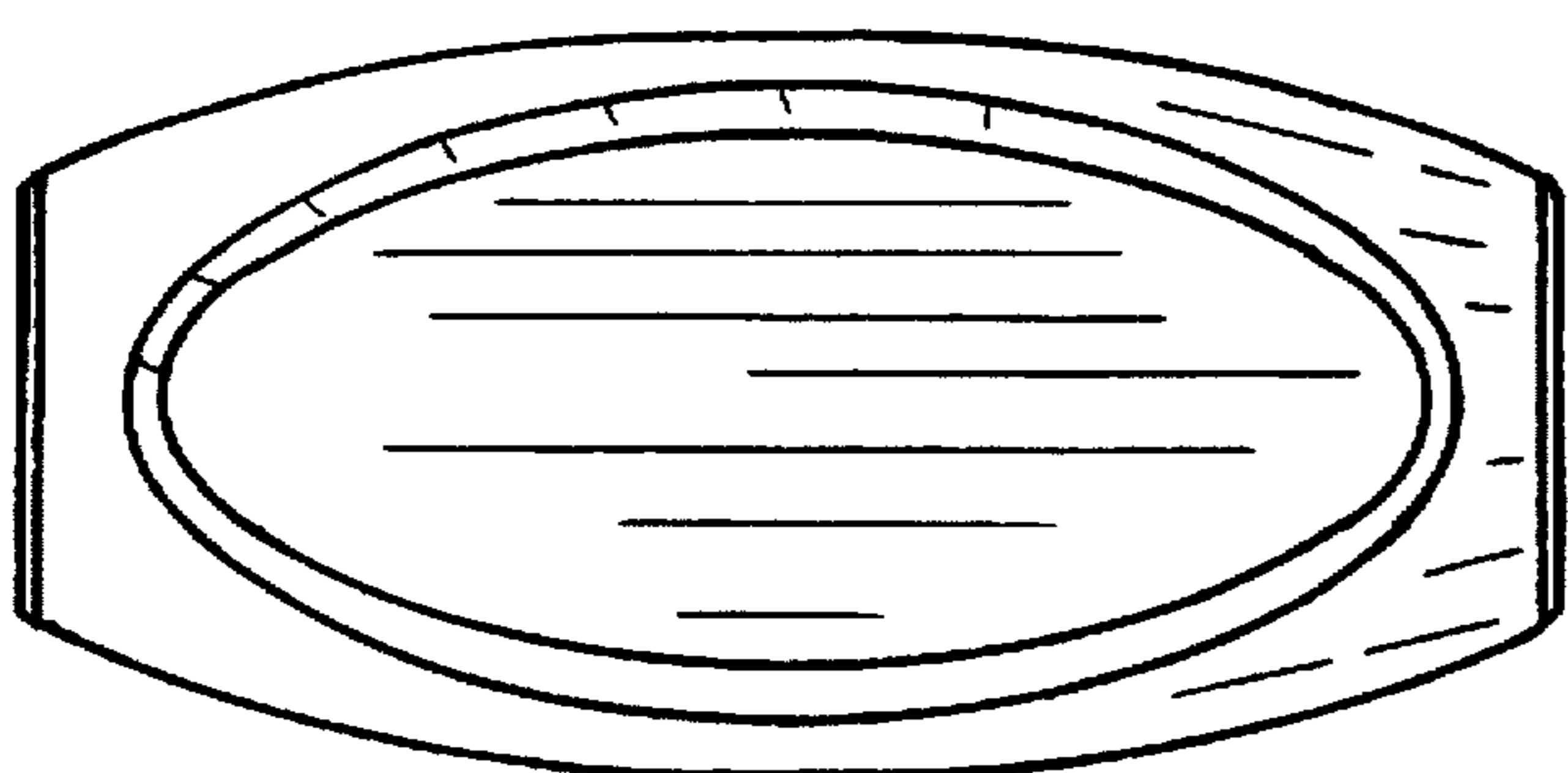

FIG. 5

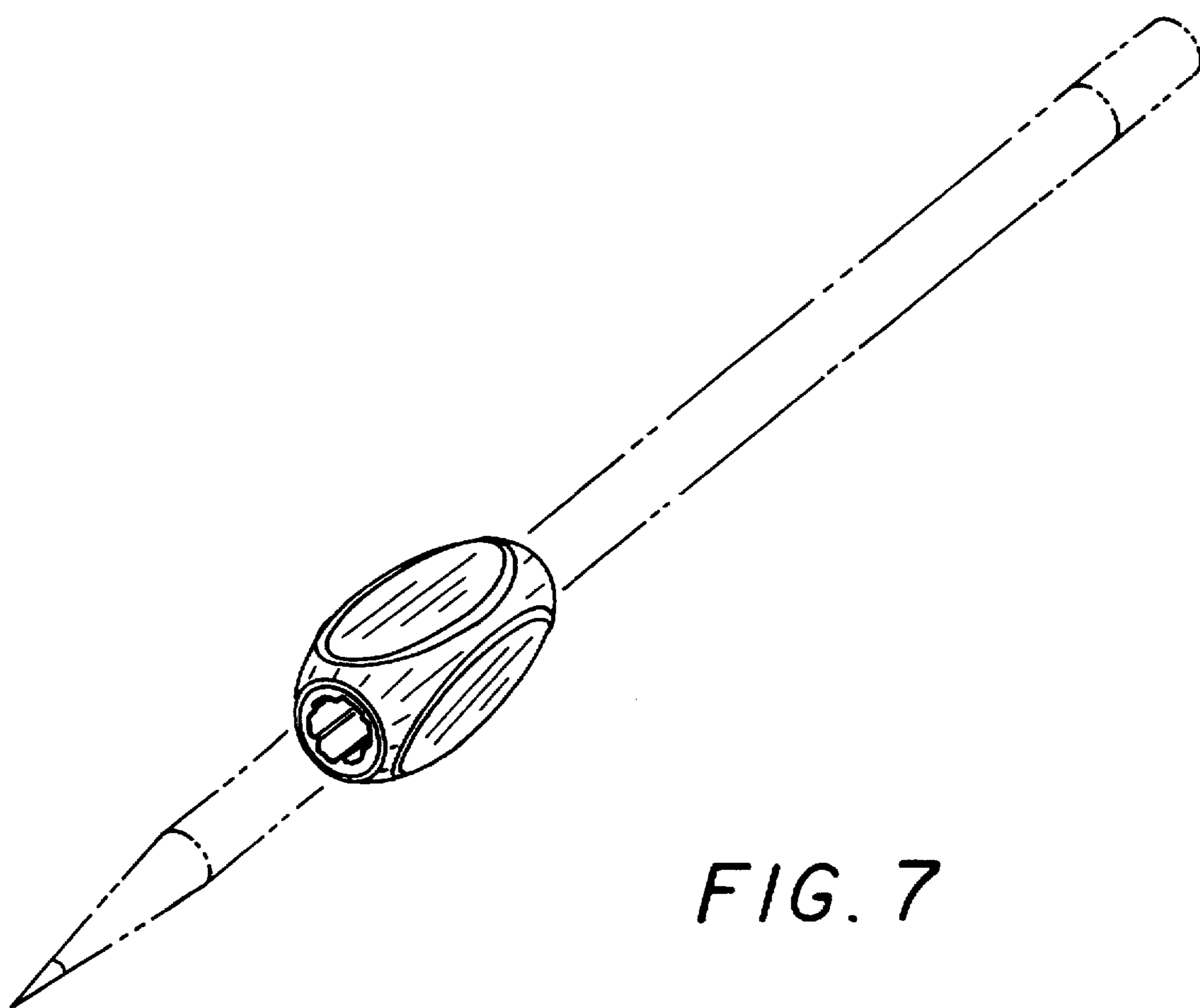

FIG. 7