



US00D395928S

**United States Patent** [19]  
**Freelander**

[11] **Patent Number:** **Des. 395,928**  
[45] **Date of Patent:** **\*\*Jul. 7, 1998**

[54] **SCOOP BODY FOR A TOY SHOVEL**

1,714,592 5/1929 Denning ..... 294/49

[76] **Inventor:** **Michael S. Freelander**, 46 Whisper Dr., Worcester, Mass. 01609

*Primary Examiner*—Sandra L. Morris  
*Assistant Examiner*—Adir Aronovich  
*Attorney, Agent, or Firm*—Salter & Michaelson

[\*\*] **Term:** **14 Years**

[57] **CLAIM**

[21] **Appl. No.:** **64,556**

The ornamental design for a scoop body for a toy shovel, as shown and described.

[22] **Filed:** **Jan. 6, 1997**

[51] **LOC (6) Cl.** ..... **21-01**

**DESCRIPTION**

[52] **U.S. Cl.** ..... **D21/120; D7/691; D8/10; D30/162**

FIG. 1 is a perspective view the present scoop body for a toy shovel showing my new design;

[58] **Field of Search** ..... D7/691, 692; D8/10; D10/46.2; D21/120; D30/162; 294/49, 54.5, 56; 446/70

FIG. 2 is a top view thereof;

FIG. 3 is a bottom view thereof;

FIG. 4 is a left side view thereof;

FIG. 5 is a right side view thereof;

FIG. 6 is a front view thereof; and,

FIG. 7 is a rear view thereof.

[56] **References Cited**

**U.S. PATENT DOCUMENTS**

D. 33,327	10/1900	Crittenden	.....	D7/691
D. 347,497	5/1994	Vanskiver	.....	D30/162
D. 387,957	12/1997	Keller et al.	.....	D7/691
1,564,720	12/1925	Surbaugh	.....	294/49

The handle portion of the toy shovel is illustrated in broken line in FIG. 1 for environmental purposes only, and it is not intended to form any part of the present design.

**1 Claim, 2 Drawing Sheets**

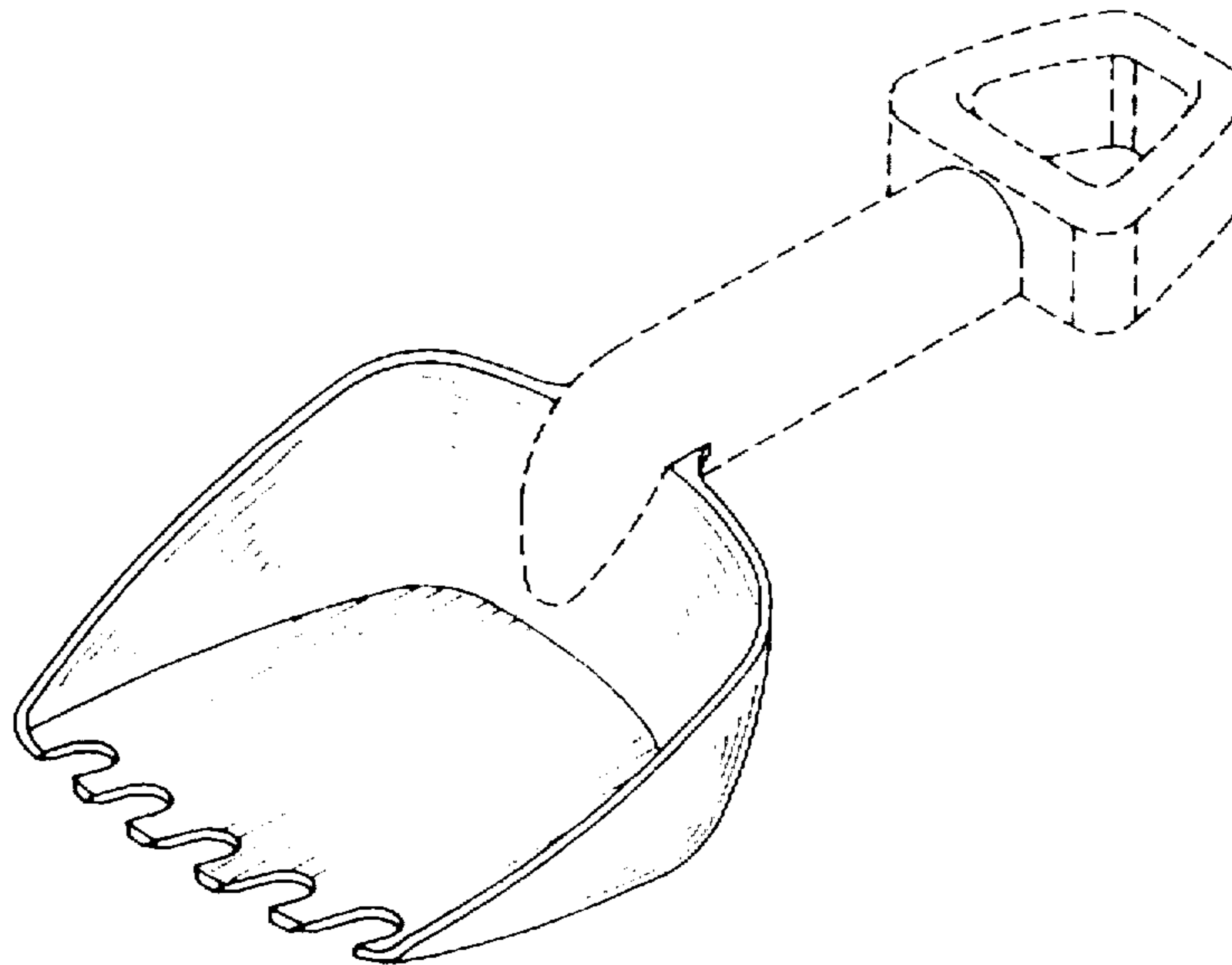

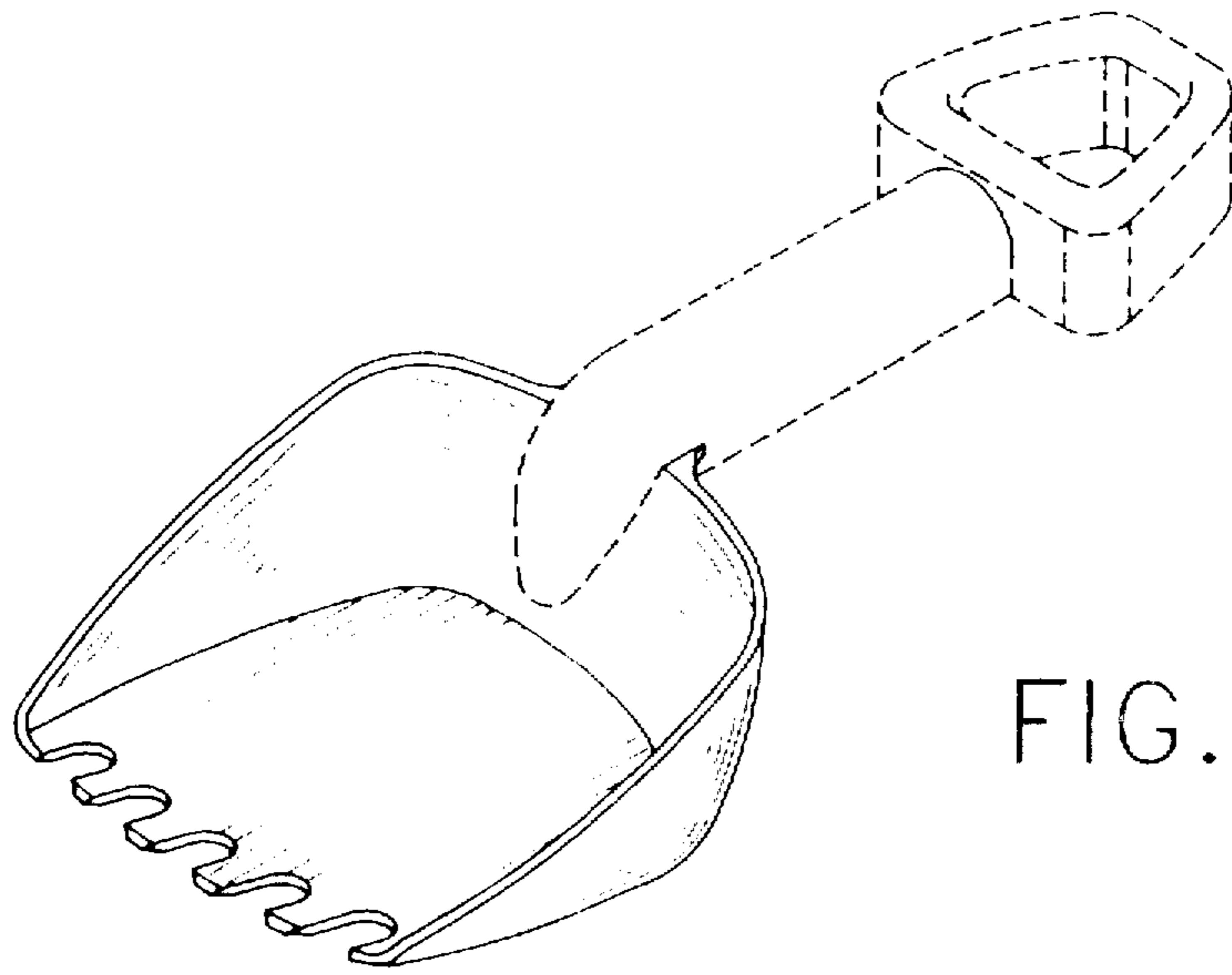

FIG. 1

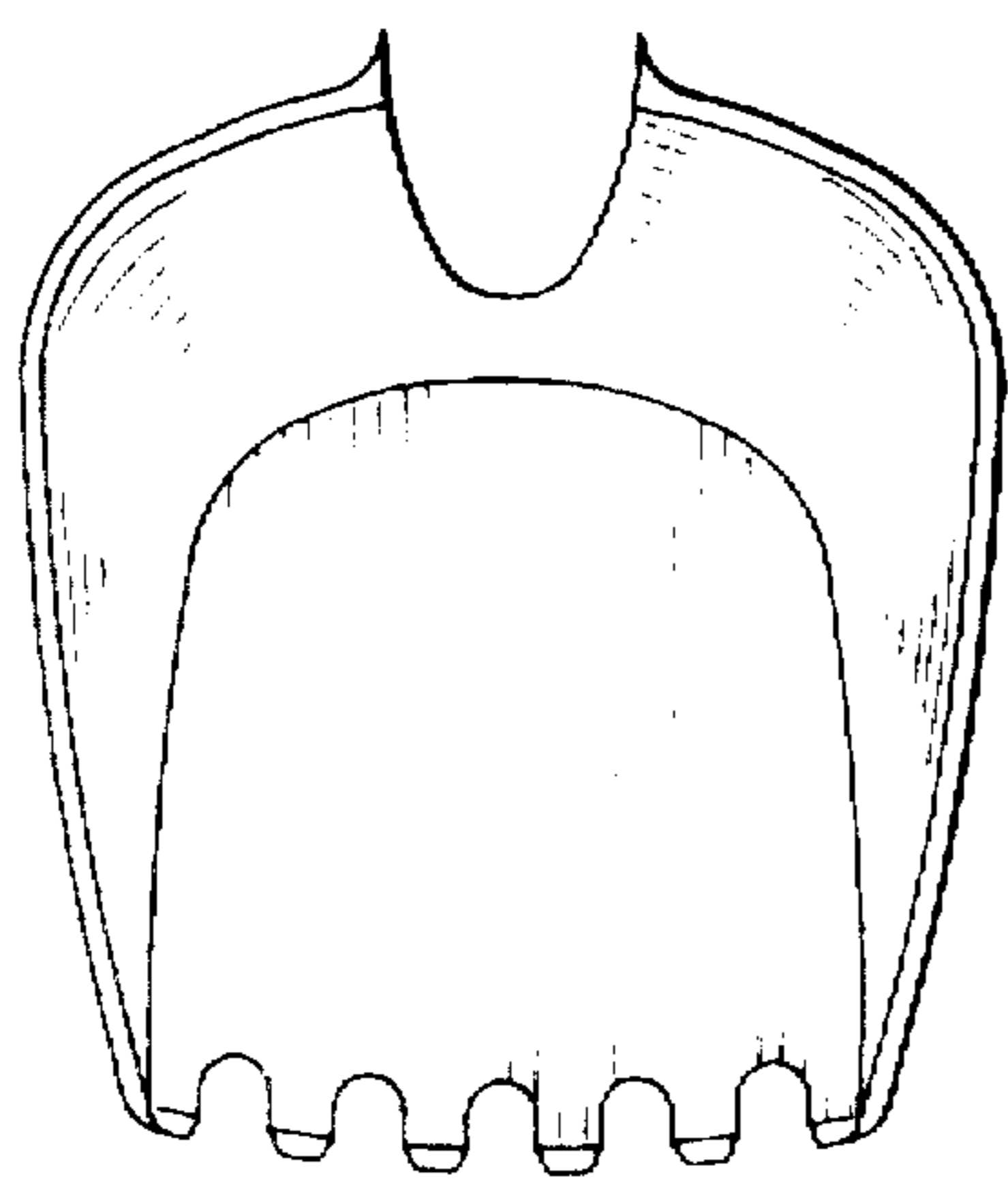

FIG. 2

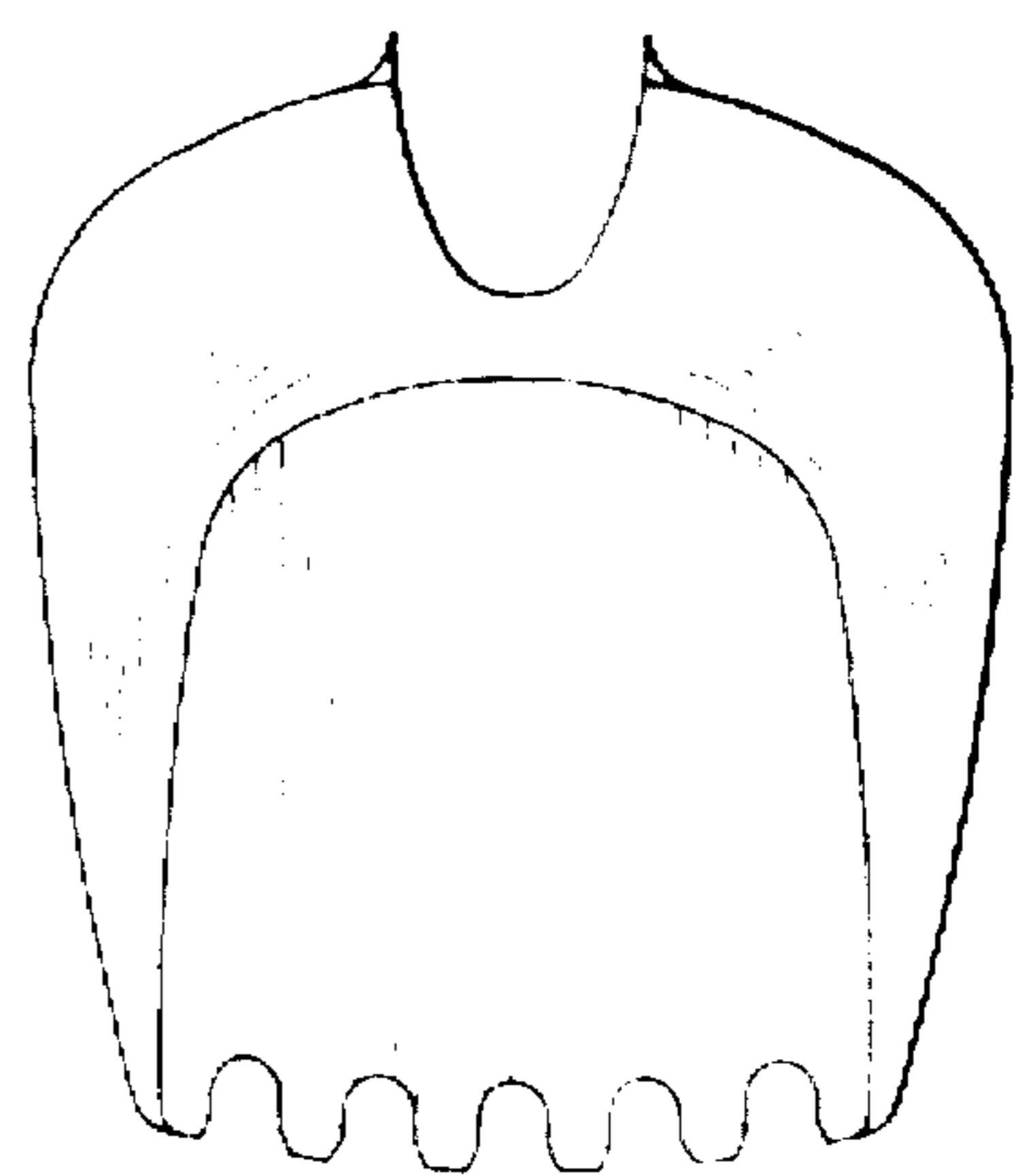

FIG. 3

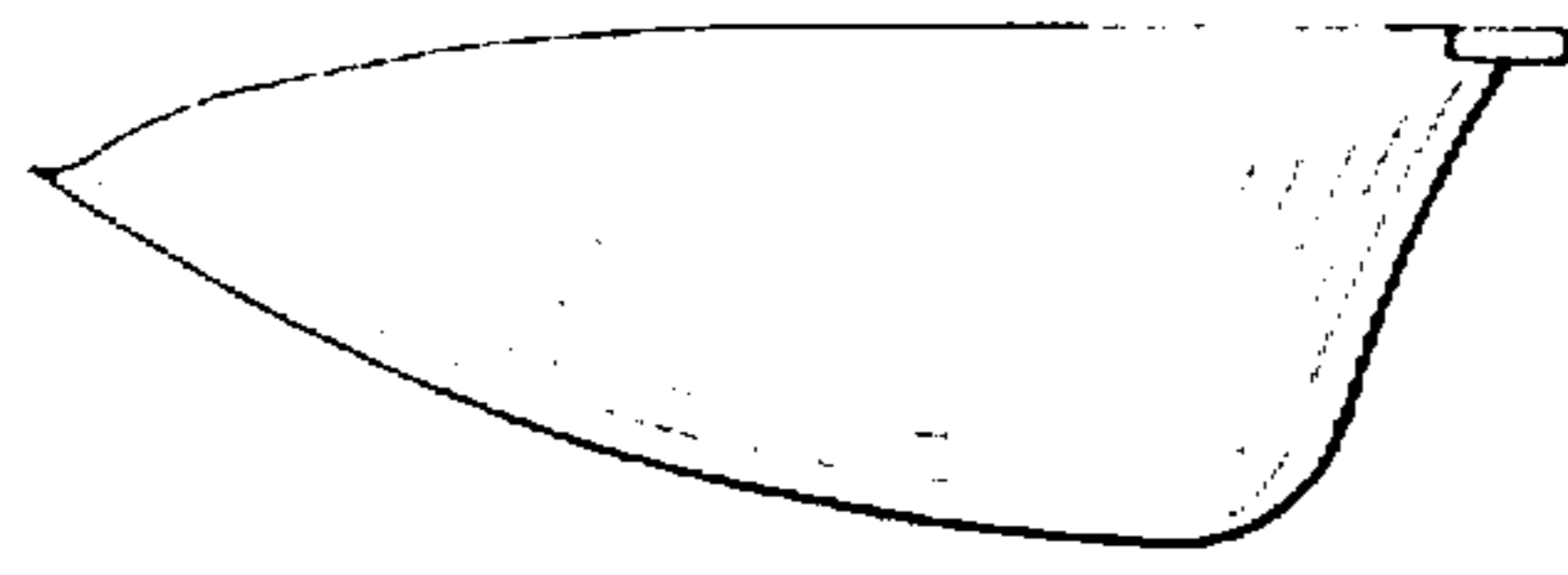

FIG. 4

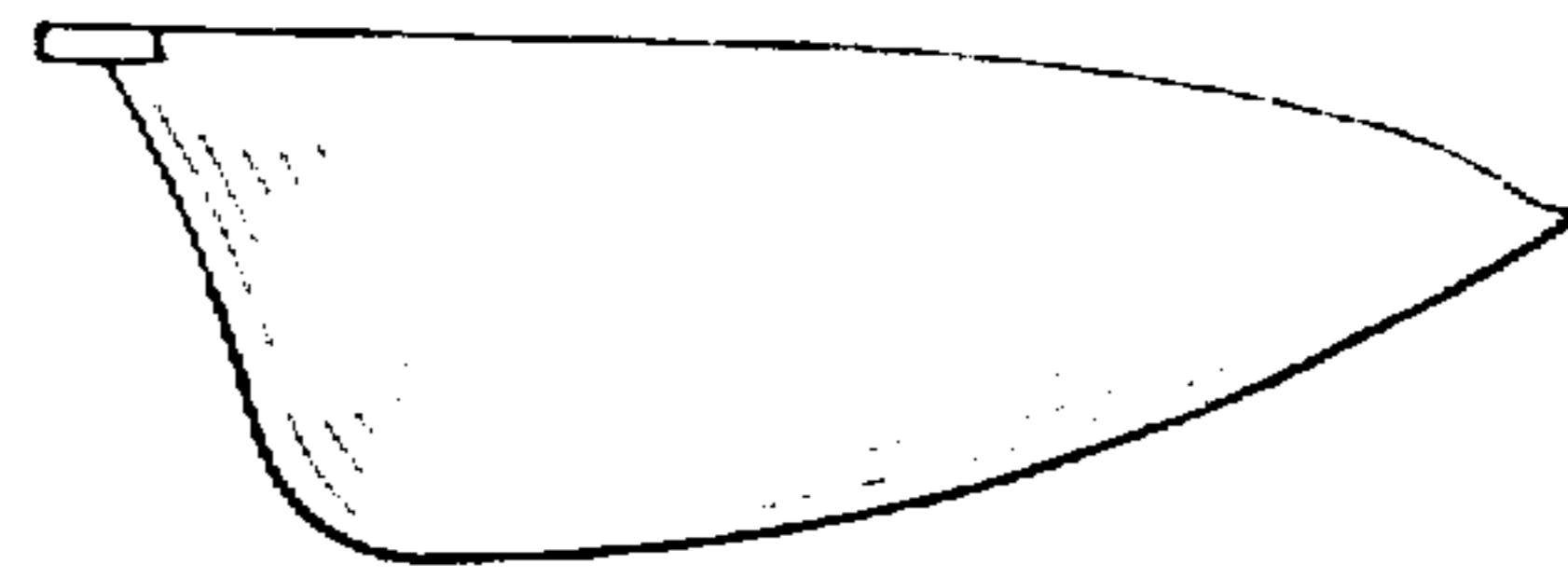

FIG. 5

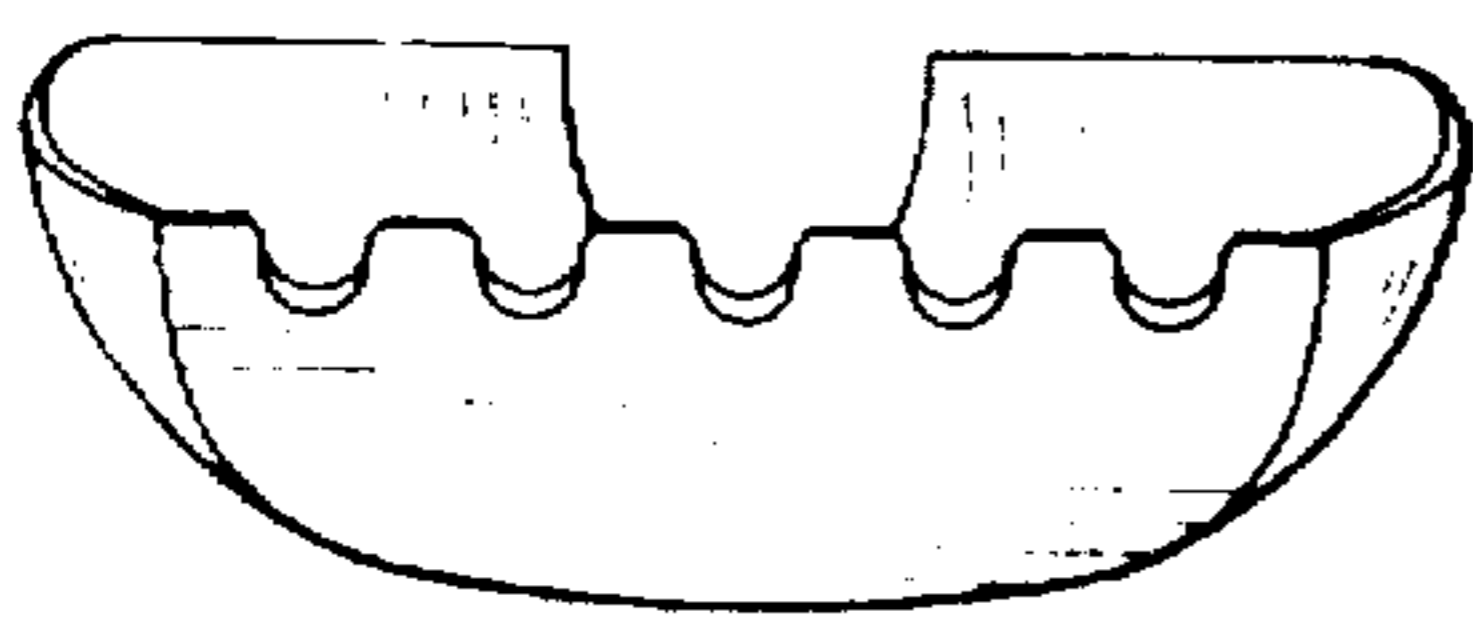

FIG. 6

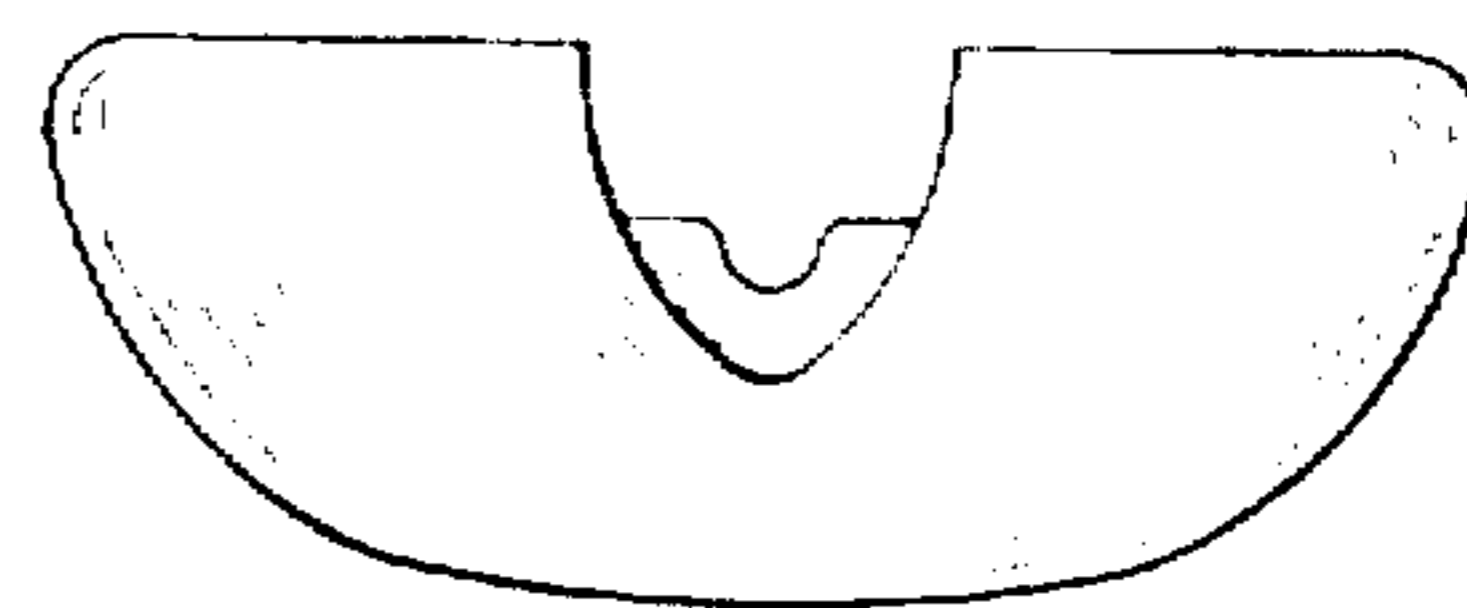

FIG. 7