



US00D395916S

United States Patent [19]

Inoue et al.

[11] Patent Number: **Des. 395,916**

[45] Date of Patent: ****Jul. 7, 1998**

[54] **COMBINED INK TANK HOLDER AND PRINTING HEAD FOR PRINTER**

5,576,750 11/1996 Brandon et al. 347/87
5,619,237 4/1997 Inoue et al. 347/86

[75] Inventors: **Manabu Inoue**, Yokohama; **Toshiaki Hirosawa**, Hiratsuka; **Osamu Morita**, Yokosuka, all of Japan

FOREIGN PATENT DOCUMENTS

583154 2/1994 European Pat. Off. 347/87
000594124 4/1994 European Pat. Off. 347/87
000639462 2/1995 European Pat. Off. 347/86
639461 2/1995 European Pat. Off. 347/86
1141560 6/1986 Japan 347/87
2261451 11/1987 Japan 347/86
2187349 7/1990 Japan 347/87
402204052 8/1990 Japan 347/87
3101945 4/1991 Japan 347/87
3234653 10/1991 Japan 347/86
4247960 9/1992 Japan 347/87
404363254 12/1992 Japan 347/87
404369559 12/1992 Japan 347/87
4347653 12/1992 Japan 347/86
5162329 6/1993 Japan 347/86
405201020 8/1993 Japan 347/87
5278227 10/1993 Japan 347/86
2241201 8/1991 United Kingdom 347/86

[73] Assignee: **Canon Kabushiki Kaisha**, Tokyo, Japan

[**] Term: **14 Years**

[21] Appl. No.: **69,121**

[22] Filed: **Apr. 11, 1997**

[30] Foreign Application Priority Data

Oct. 16, 1996 [JP] Japan 8-30937

[51] LOC (6) CL. **18-02**

[52] U.S. Cl. **D18/56; 347/87**

[58] Field of Search **D18/56, 43; 347/86-87; 101/348**

Primary Examiner—Cathy Anne MacCormac
Attorney, Agent, or Firm—Fitzpatrick, Cella, Harper & Scinto

[56] References Cited

U.S. PATENT DOCUMENTS

D. 352,058 11/1994 Kubota et al. D18/56
D. 371,804 7/1996 Kotaki et al. D18/56
D. 382,013 8/1997 Tashiro et al. D18/56
D. 382,014 8/1997 Tashiro et al. D18/56
4,709,246 11/1987 Piatt et al. 347/87
4,998,115 3/1991 Nevarez et al. 347/87
5,182,581 1/1993 Kashimura et al. 347/87
5,314,257 5/1994 Cheng D18/56
5,328,279 7/1994 Suzuki et al. D18/56
5,392,063 2/1995 Rhoads 347/86
5,406,885 4/1995 Privin 101/348
5,408,746 4/1995 Thoman et al. 347/87
5,497,178 3/1996 DeFosse et al. 347/87
5,500,665 3/1996 Ujita et al. 347/87
5,506,611 4/1996 Ujita et al. 347/86

[57] CLAIM

The ornamental design for an combined ink tank holder and printing head for printer, as shown and described.

DESCRIPTION

FIG. 1 is a front view of an combined ink tank holder and printing head for printer showing our new design;
FIG. 2 is a rear view thereof;
FIG. 3 is a top plan view thereof;
FIG. 4 is a bottom plan view thereof;
FIG. 5 is a left side view thereof;
FIG. 6 is a right side view thereof; and
FIG. 7 is a perspective view thereof.

1 Claim, 5 Drawing Sheets

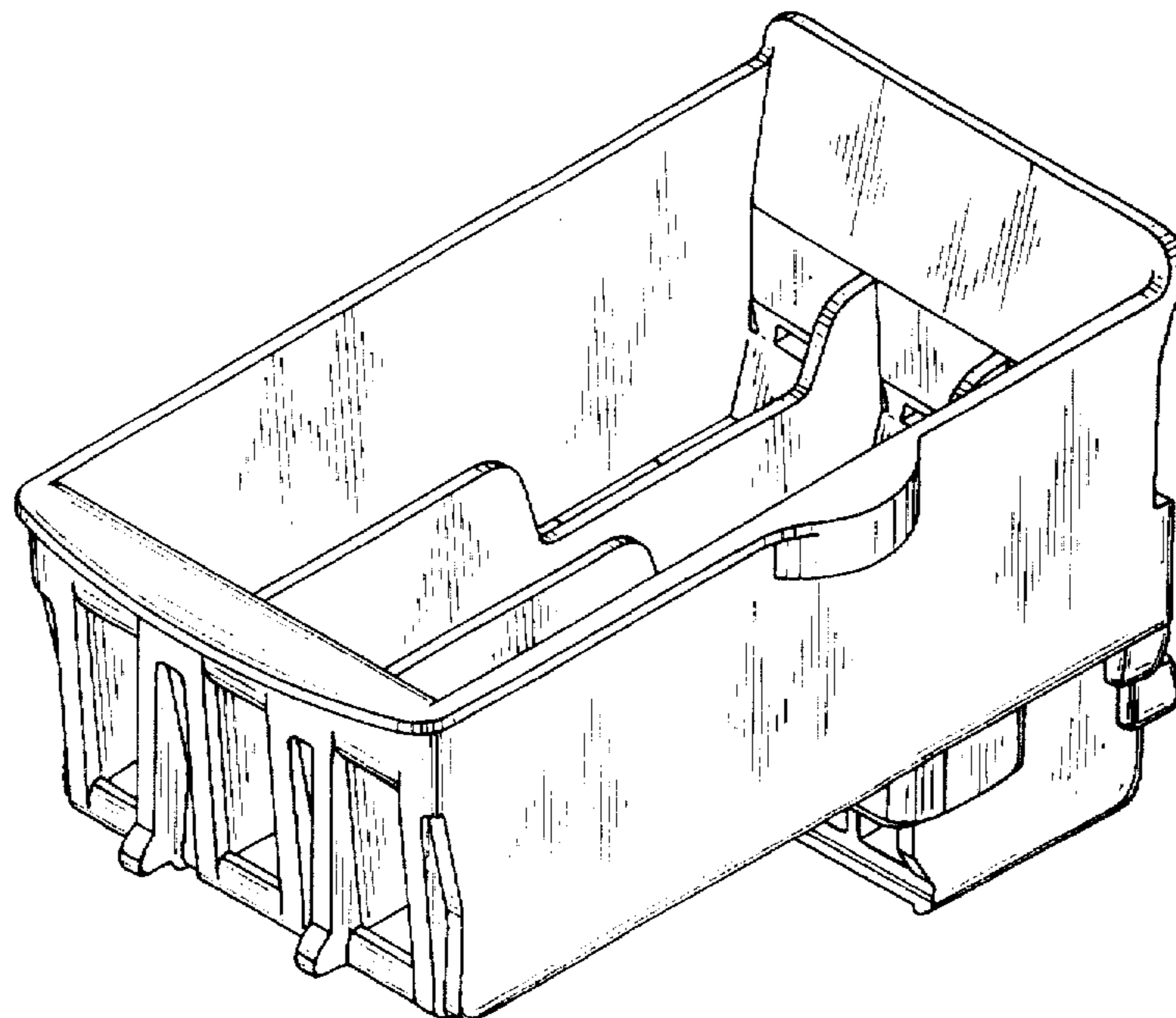

FIG. 1

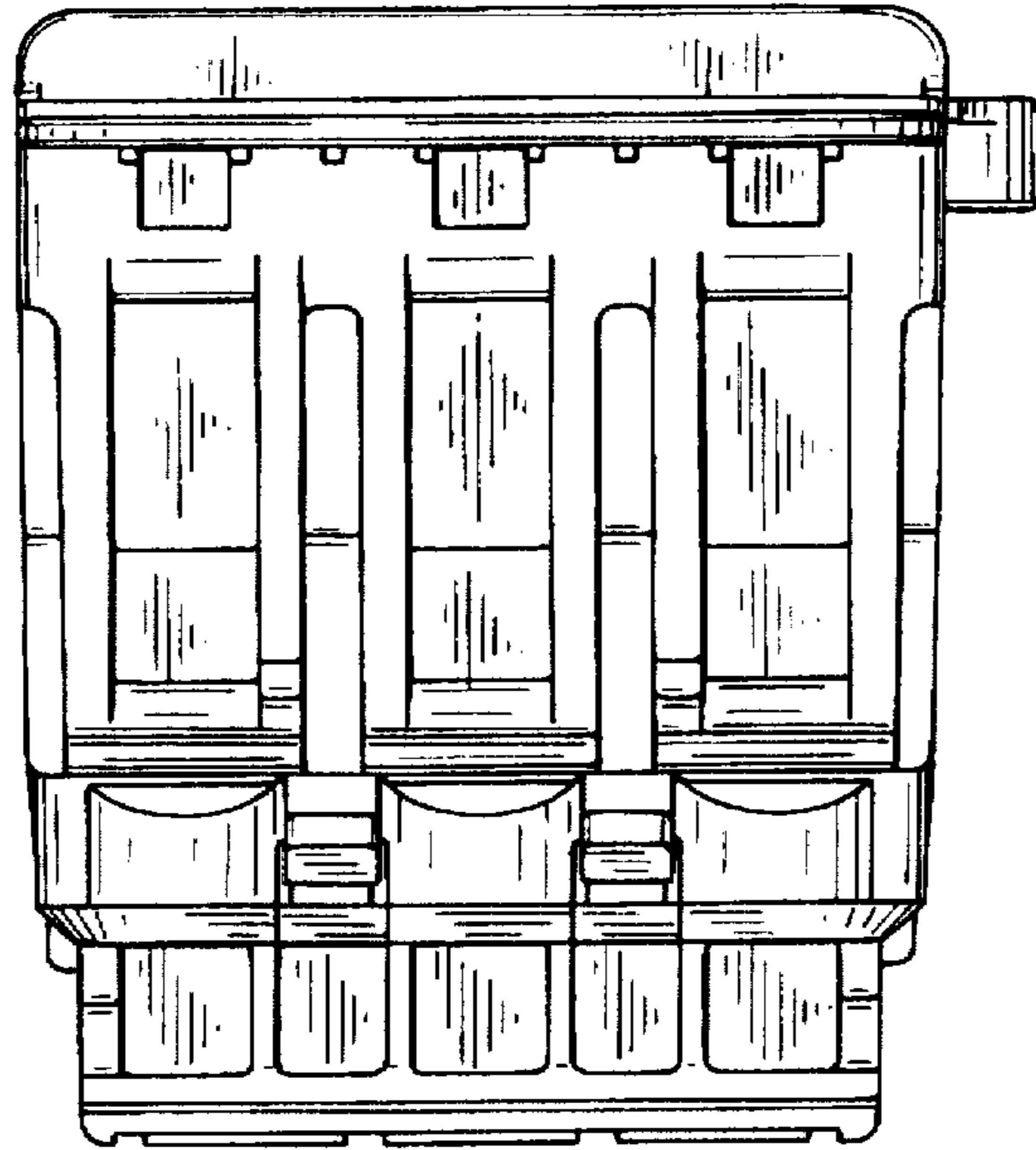

FIG. 2

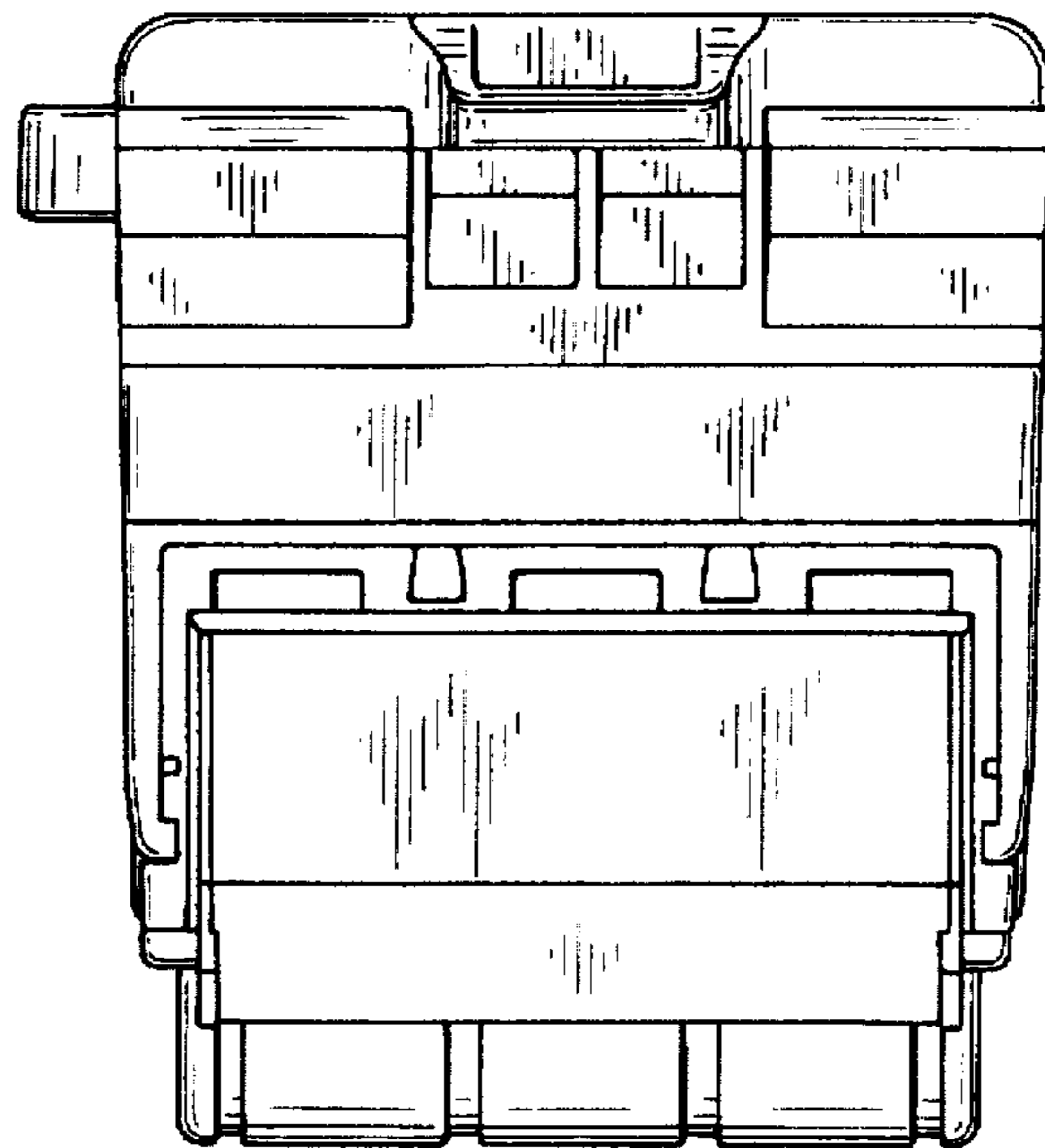

FIG. 3

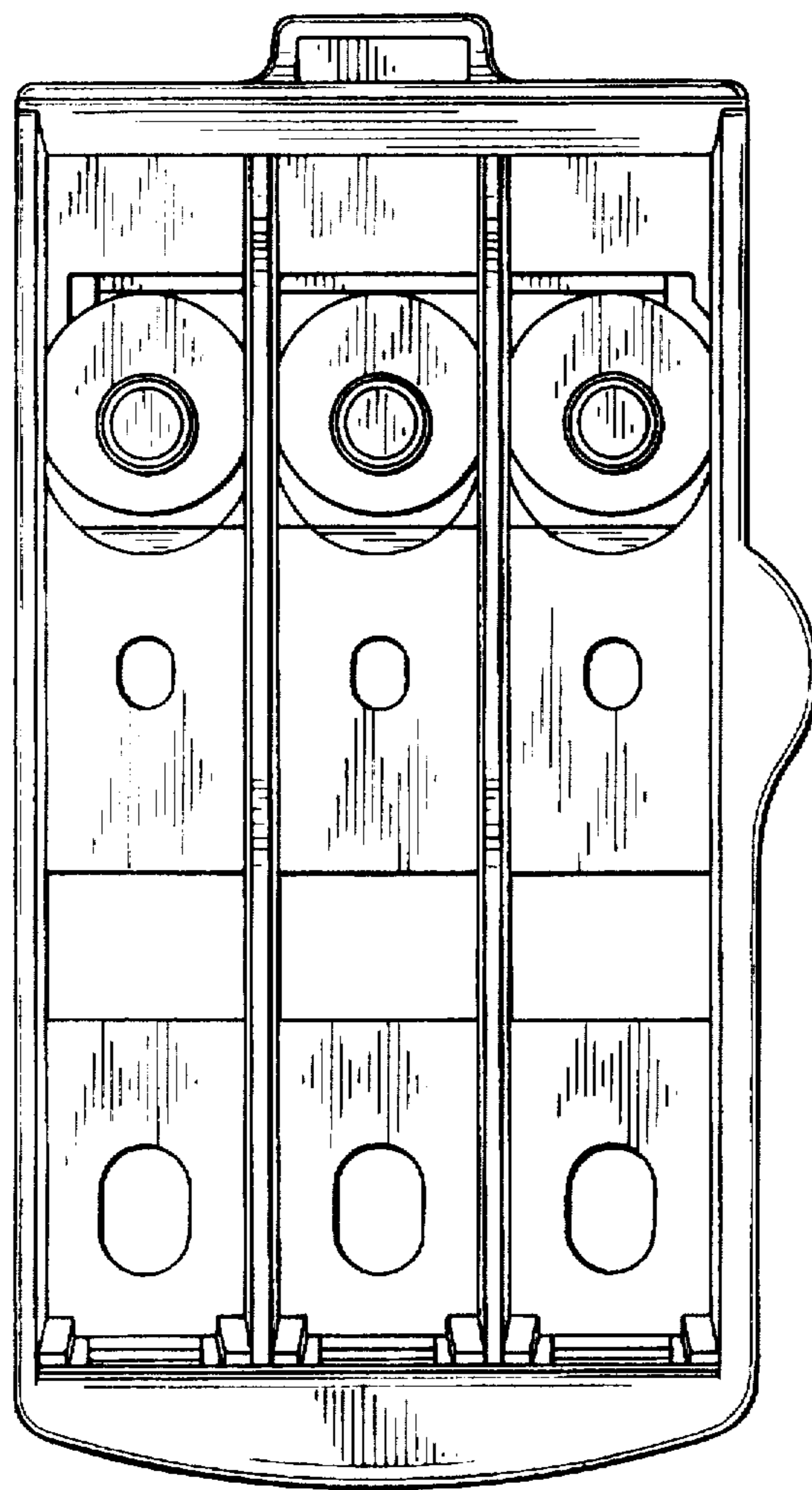

FIG. 4

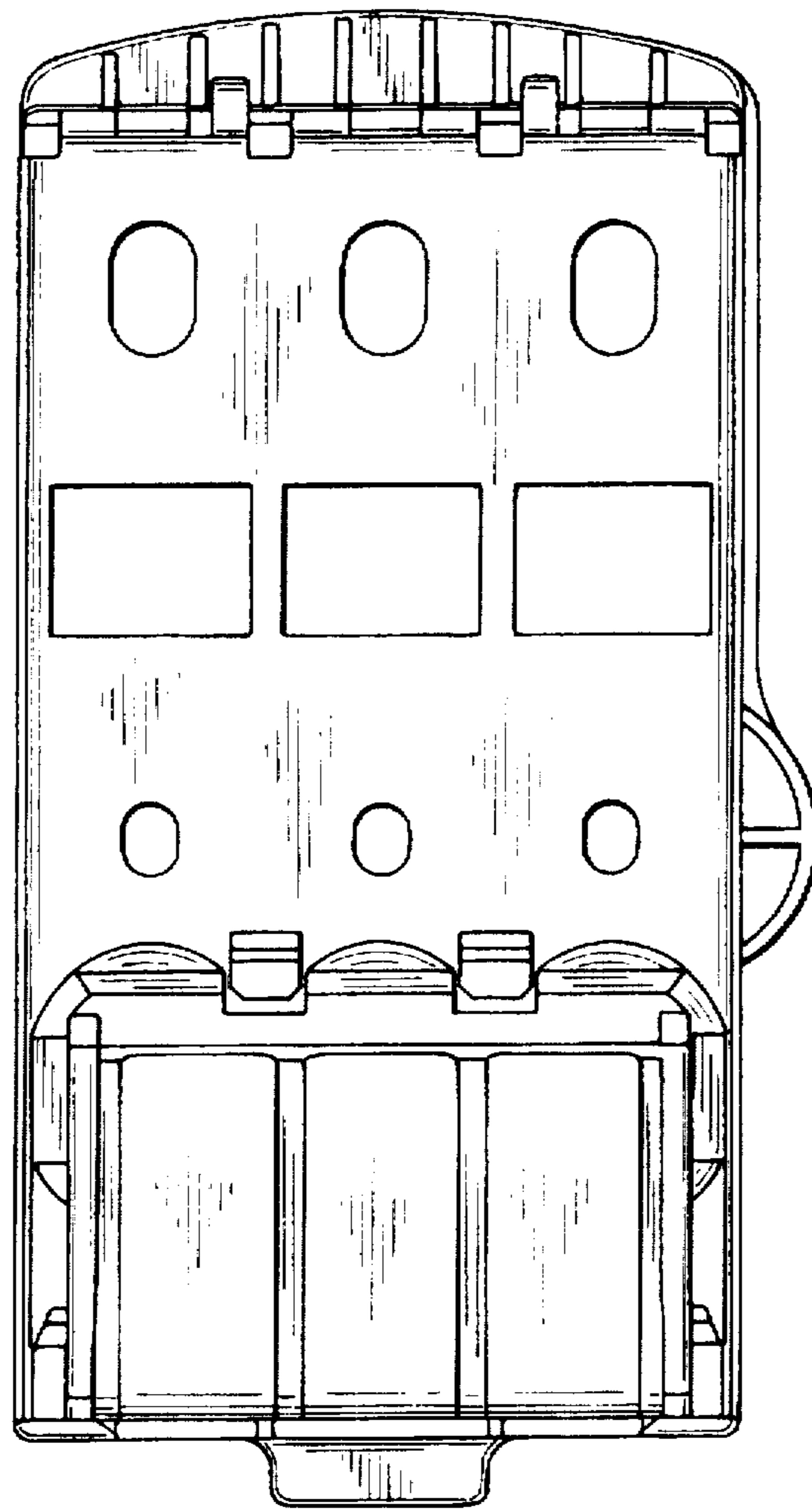

FIG. 5

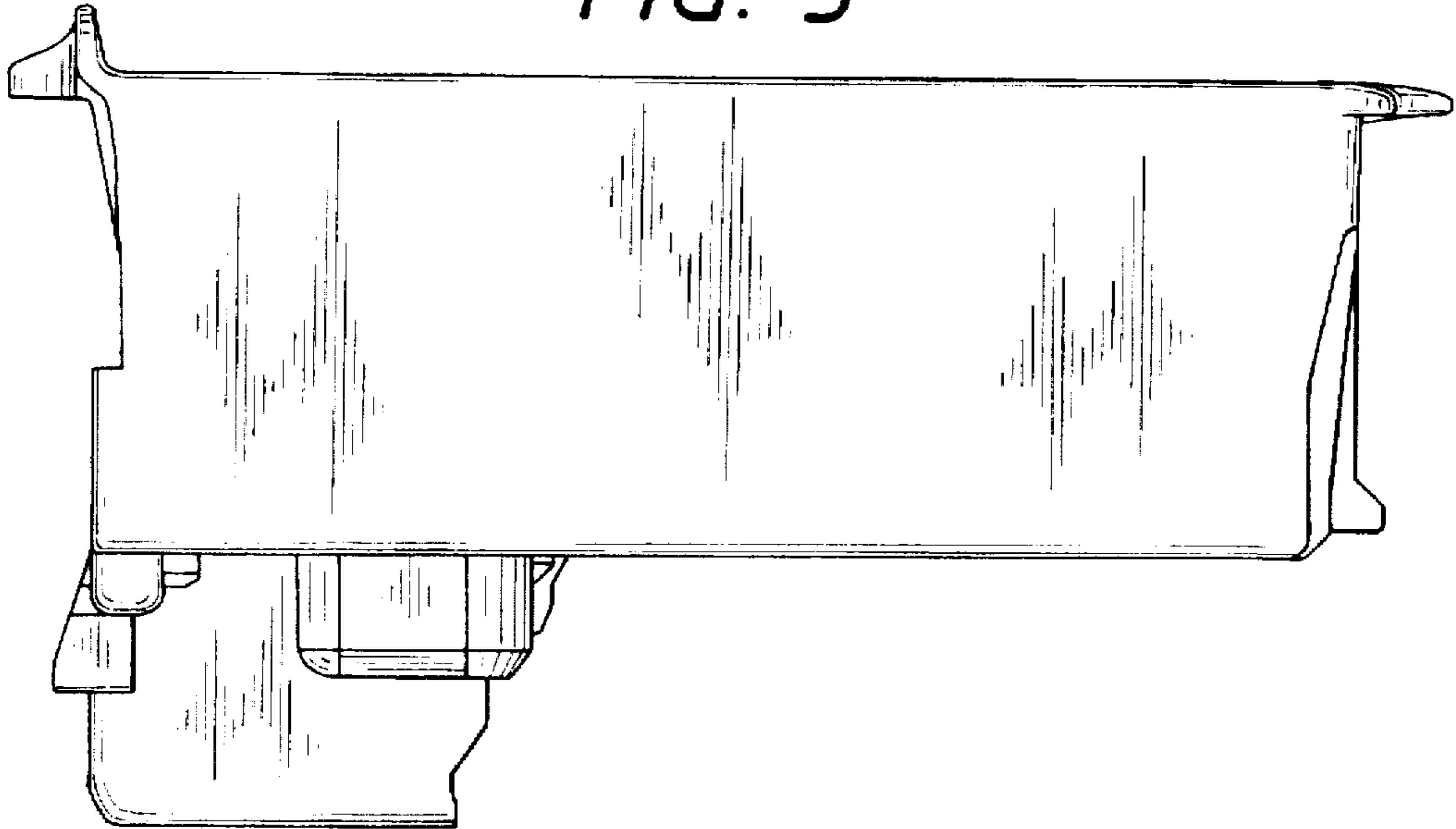

FIG. 6

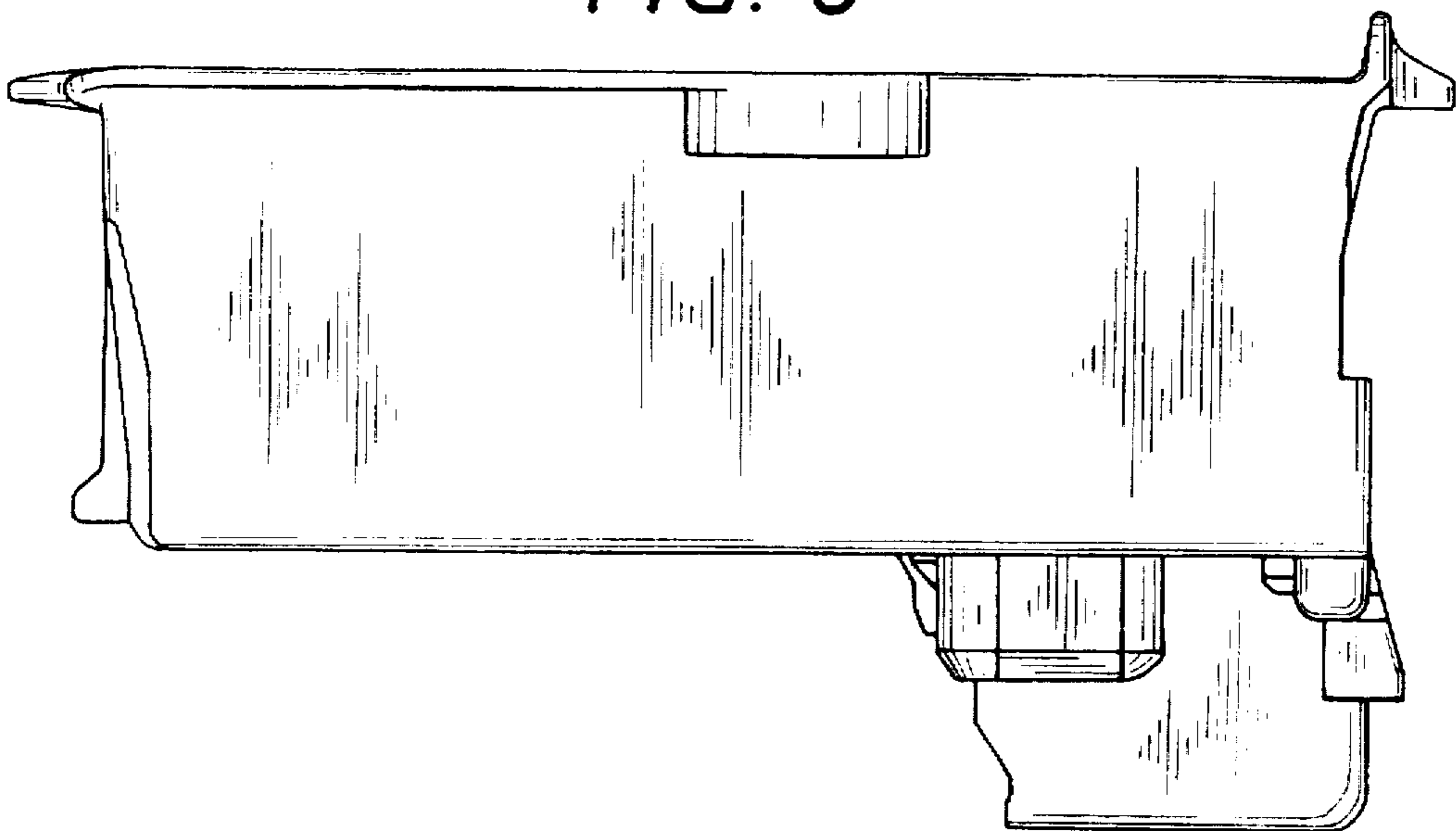
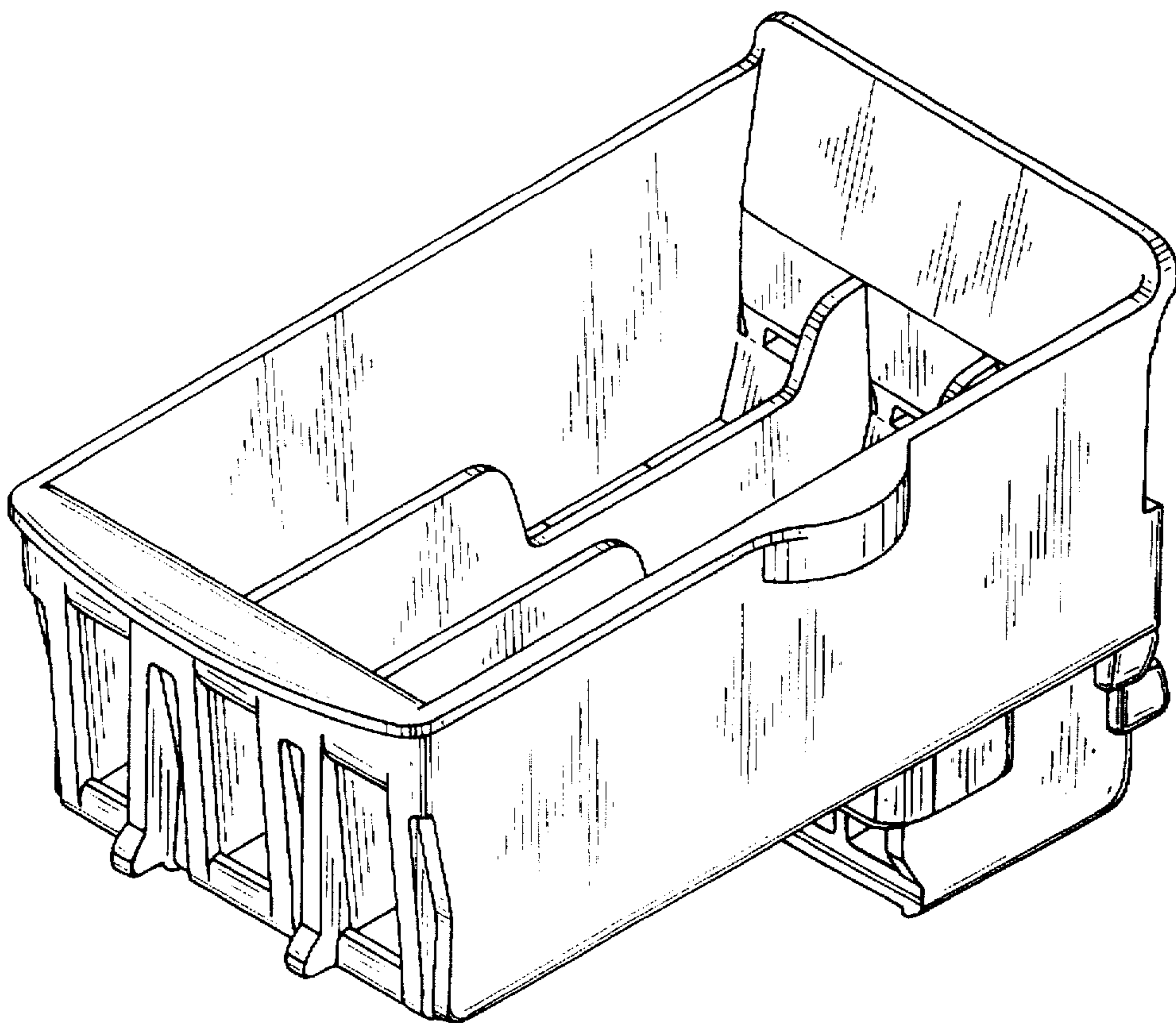

FIG. 7



UNITED STATES PATENT AND TRADEMARK OFFICE
CERTIFICATE OF CORRECTION

PATENT NO. : DES. 395,916

DATED : July 7, 1998

INVENTOR(S) : MANABU INOUE ET AL.

Page 1 of 2

It is certified that error appears in the above-identified patent and that said Letters Patent is hereby corrected as shown below:

TITLE PAGE:

[56] REFERENCES CITED

"1141560" should read --61-141560--.

"2261451" should read --62-261451--.

"2187349" should read --2-187349--.

"402204052" should read --2-204052--.

"3101945" should read --3-101945--.

"3234653" should read --3-234653--.

"4247960" should read --4-247960--.

"404363254" should read --4-363254--.

"404369559" should read --4-369559--.

"4347653" should read --4-347653--.

"5162329" should read --5-162329--.

"405201020" should read --5-201020--.

"5278227" should read --5-278227--.

UNITED STATES PATENT AND TRADEMARK OFFICE
CERTIFICATE OF CORRECTION

PATENT NO. : DES. 395,916
DATED : July 7, 1998
INVENTOR(S) : MANABU INOUE ET AL.

Page 2 of 2

It is certified that error appears in the above-identified patent and that said Letters Patent is hereby corrected as shown below:

[57] CLAIM

"an" should read --a--.

[57] DESCRIPTION

Line 1, "an" should read --a--.

Signed and Sealed this
Twenty-fourth Day of November, 1998

Attest:



BRUCE LEHMAN

Attesting Officer

Commissioner of Patents and Trademarks