



US00D395812S

# United States Patent [19]

Doughty et al.

[11] Patent Number: **Des. 395,812**

[45] Date of Patent: **\*\*\*Jul. 7, 1998**

## [54] HANDLE HUB

[75] Inventors: **Frederic C. Doughty**, South Pasadena;  
**Darren M. Mark**, Valencia, both of  
Calif.

[73] Assignee: **Emhart Inc.**, Newark, Del.

[\*] Notice: The portion of the term of this patent  
subsequent to Mar. 10, 2012, has been  
disclaimed.

[\*\*] Term: **14 Years**

[21] Appl. No.: **72,405**

[22] Filed: **Jun. 16, 1997**

[51] LOC (6) Cl. .... **08-06**

[52] U.S. Cl. .... **D8/321; D8/308; D23/250**

[58] Field of Search ..... **D8/307, 308, 321,**  
**D8/352; D23/249-254; 16/110 R, 121;**  
**4/675, 676, 678**

## [56] References Cited

### U.S. PATENT DOCUMENTS

D. 117,172	10/1939	Fraser .	
D. 175,819	10/1955	Young .....	D23/252
D. 254,147	2/1980	Colani .	
D. 268,515	4/1983	Thompson .	
D. 268,516	4/1983	Thompson .	
D. 268,517	4/1983	Thompson .	
D. 305,863	2/1990	Gresens .....	D8/352
D. 318,717	7/1991	Spangler .	
D. 327,532	6/1992	Ko .	
D. 339,190	9/1993	Dieramico .....	D8/308
D. 349,228	8/1994	Jans .....	D8/308
D. 357,525	4/1995	Fabian .....	D23/252
D. 364,216	11/1995	Hill et al. .	
D. 365,384	12/1995	Robbins .	
D. 372,300	7/1996	Fabian .	
D. 372,764	8/1996	Dubin .	
1,562,980	11/1925	Muend .	

## OTHER PUBLICATIONS

Harden Industries, Inc., "Top Brass Series". pp. 18, 19 and 81 (undated).

American Standard, Inc., 1993, "Amarilis" faucets, pp. 10 and 11.

Artistic Brass, A Division of Masco Corporation of Indiana, 1996, "Premier Collection".

Artistic Brass, A Division of Masco Corporation of Indiana, 1996, "Bath & Accessories".

Delta Faucet Company, A Division of Masco Corporation of Indiana, 1996, pp. 18 through 27.

Kohler Design Manual K-500; p. 18; "Antique Curio" handle hub.©1990.

American Standard; p. D-2; "Sottini" handle hub, Aug. 15, 1995.

*Primary Examiner*—B. J. Bullock

*Attorney, Agent, or Firm*—Harold Weinstein

## [57] CLAIM

The ornamental design for a handle hub, as shown and described.

## DESCRIPTION

FIG. 1 is a perspective view of our new design of a handle hub;

FIG. 2 is a top plan view of our new design of the handle hub;

FIG. 3 is a bottom plan view of our new design of the handle hub;

FIG. 4 is a front elevational view of our new design of the handle hub, a rear elevational view thereof being a mirror image of the front elevational view;

FIG. 5 is a right side elevational view of our new design of the handle hub; and,

FIG. 6 is a left side elevational view of our new design of the handle hub.

The broken line representation of a lever handle shown in FIG. 1 is for illustrative purposes only and forms no part of the claimed design.

**1 Claim, 2 Drawing Sheets**

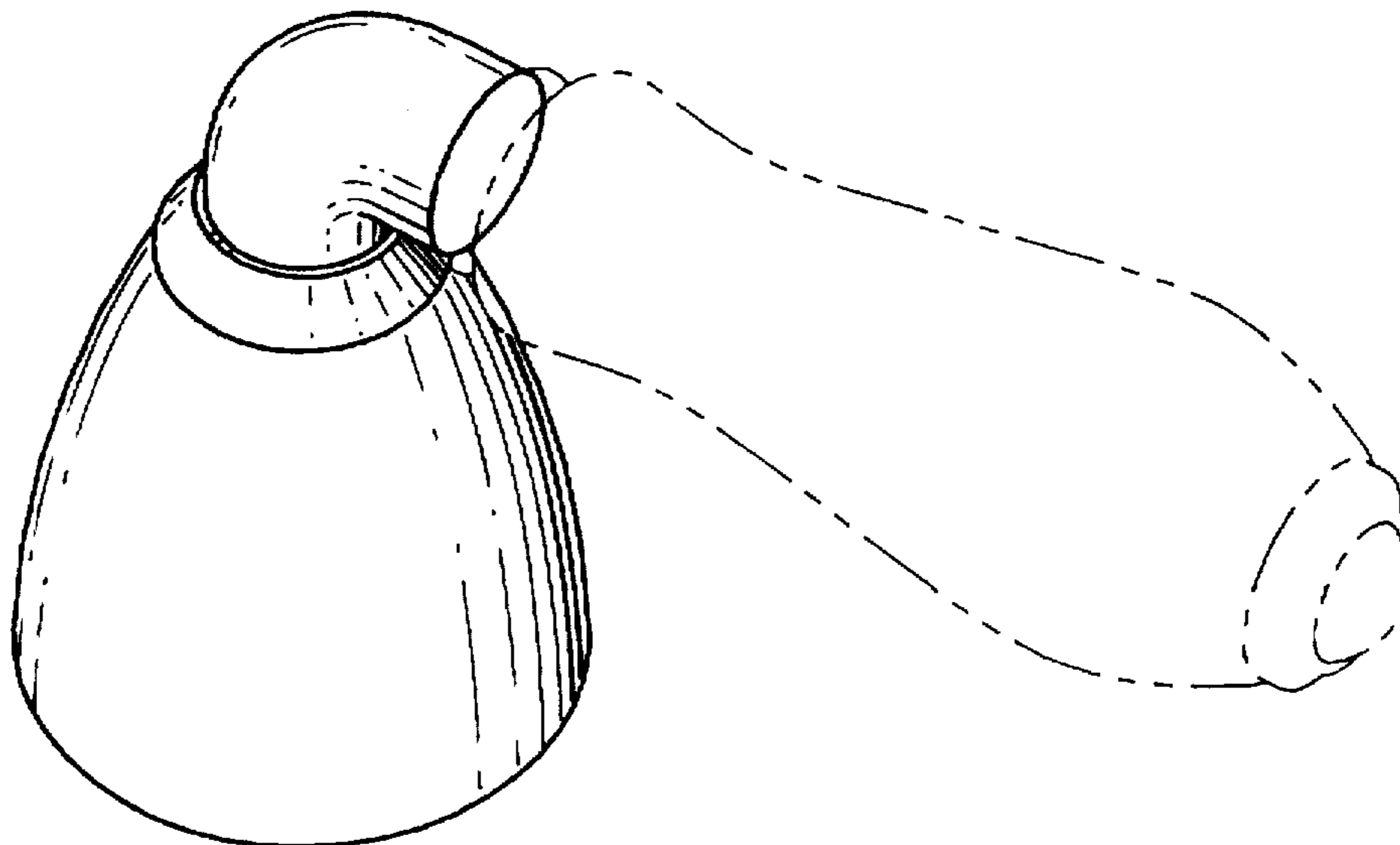

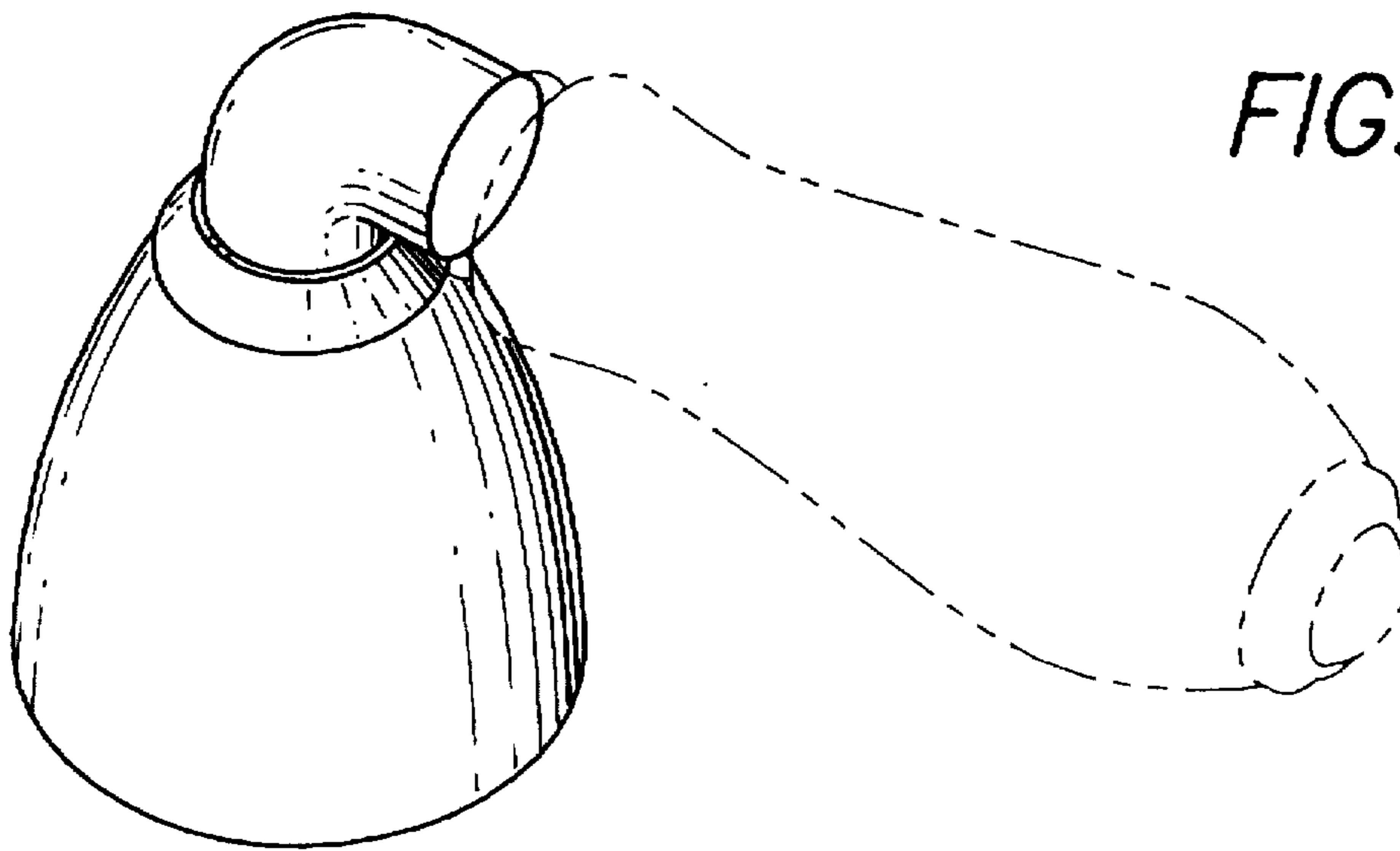

FIG. 1

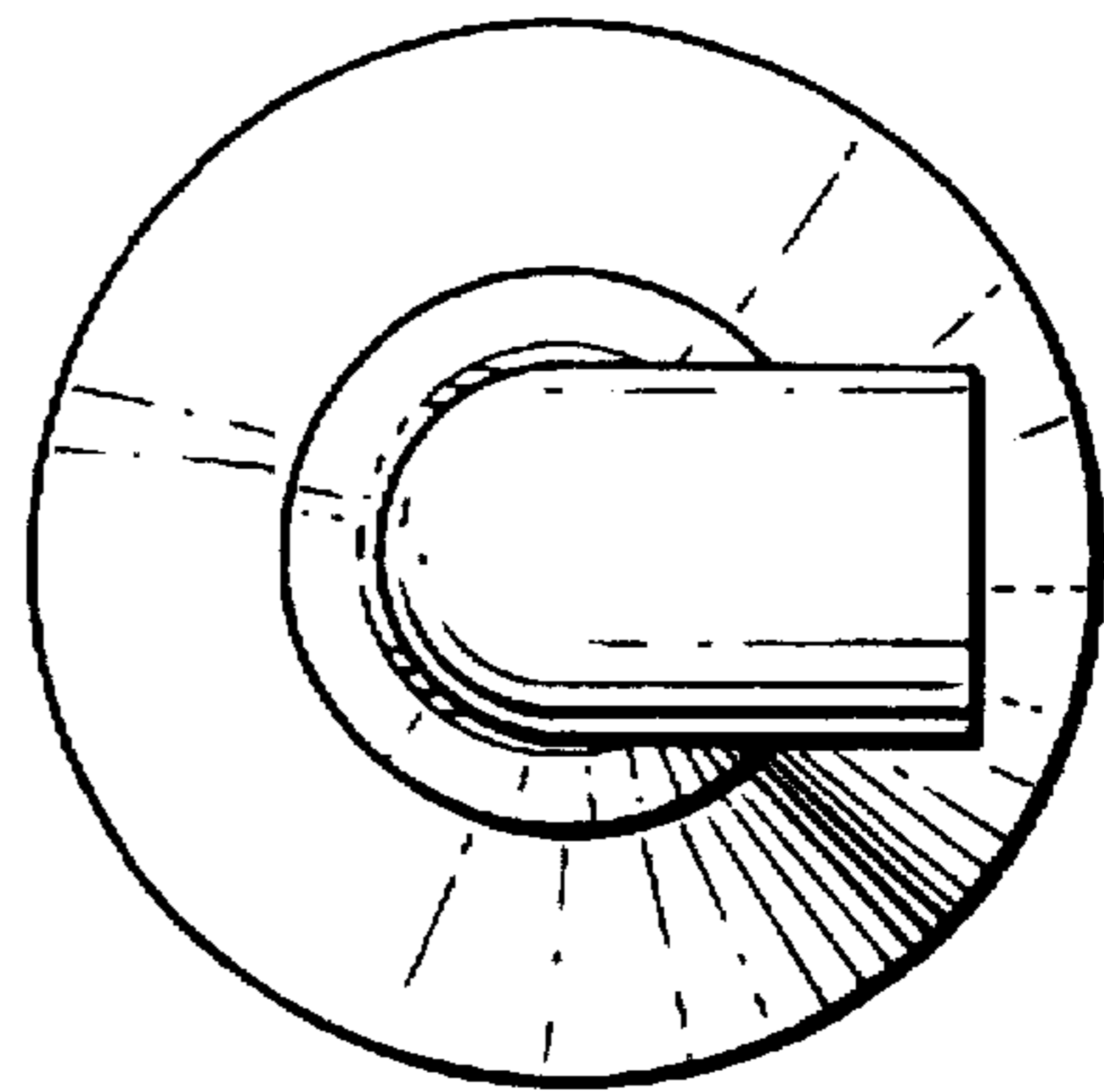

FIG. 2

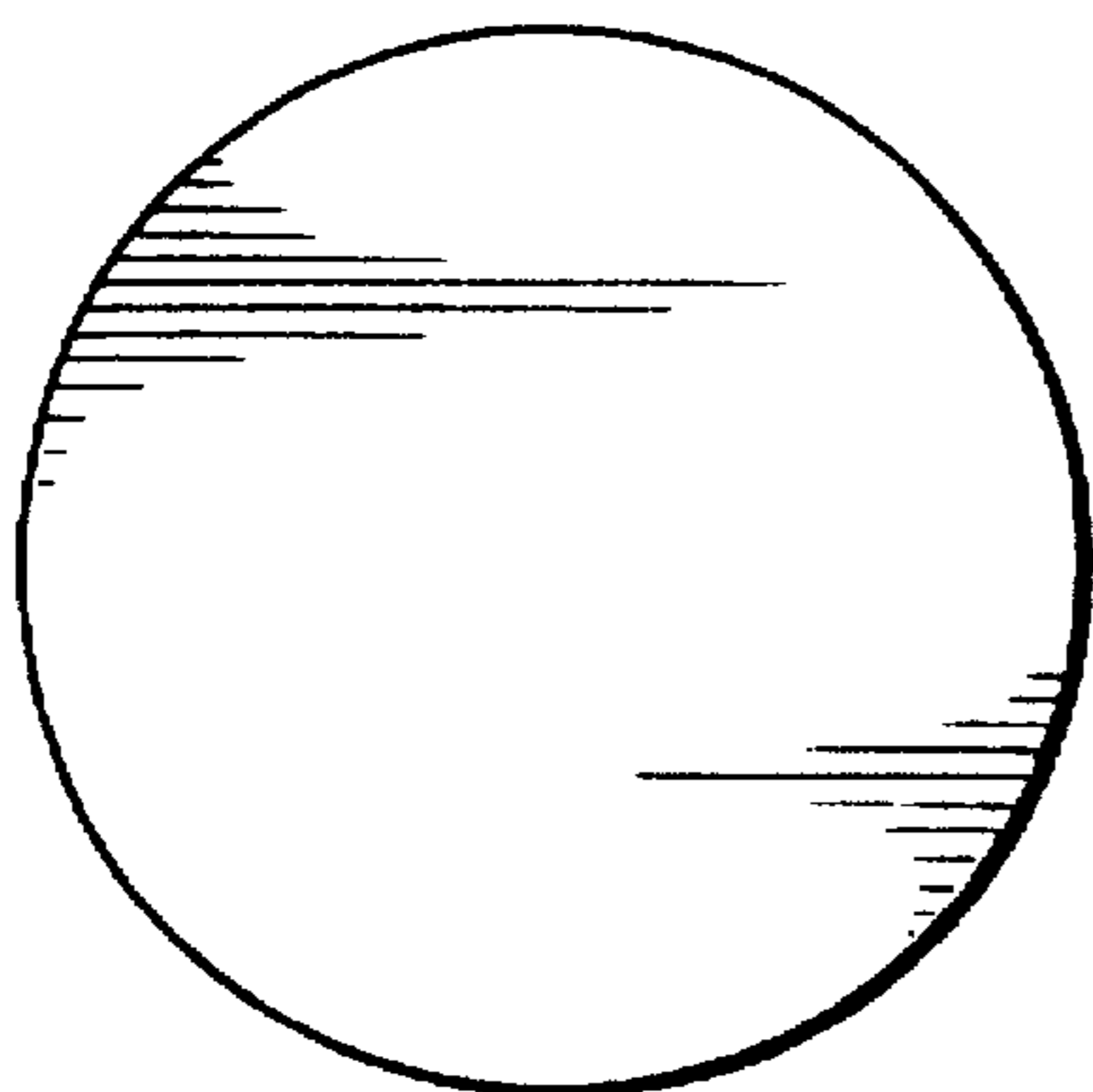

FIG. 3

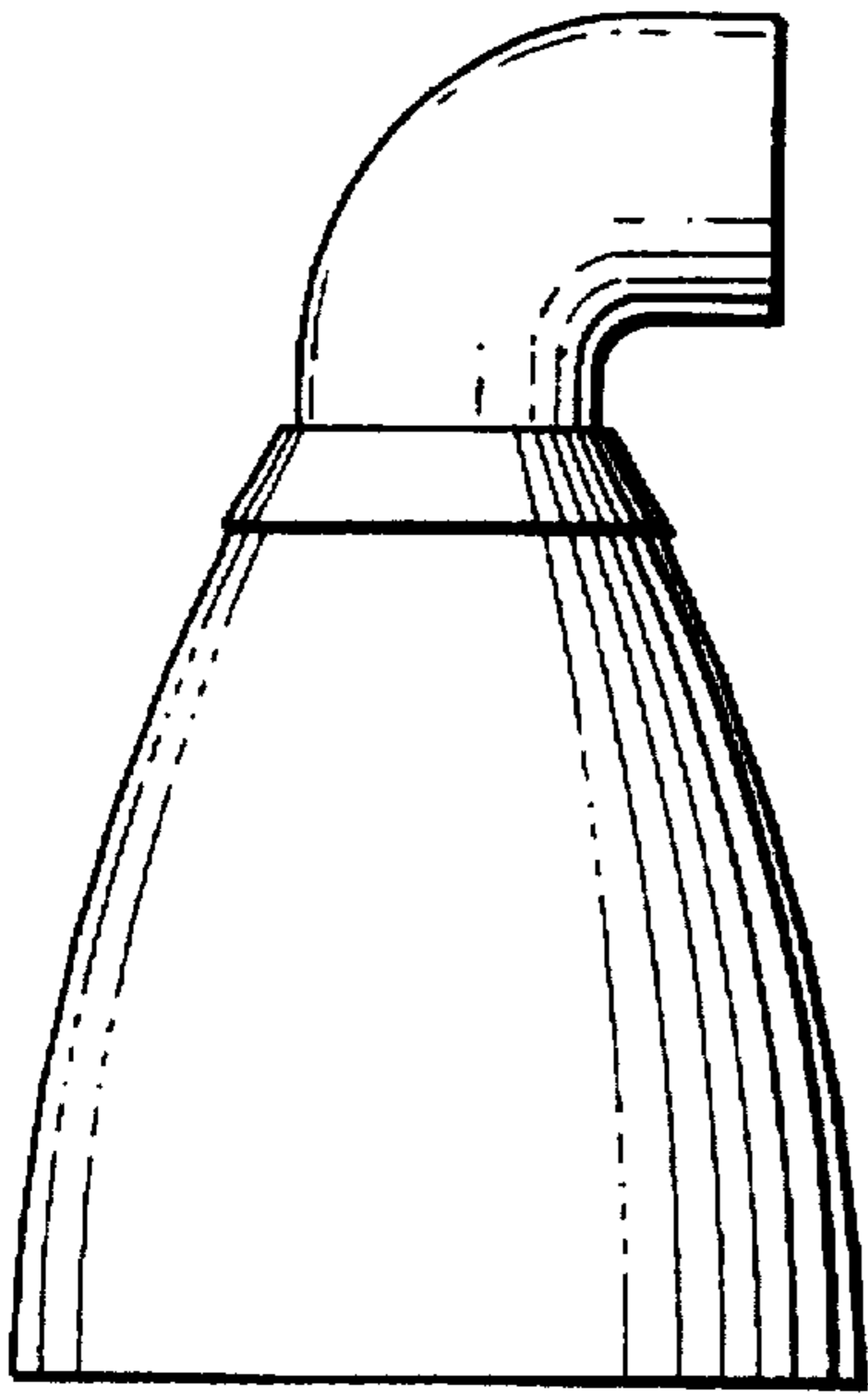

FIG. 4

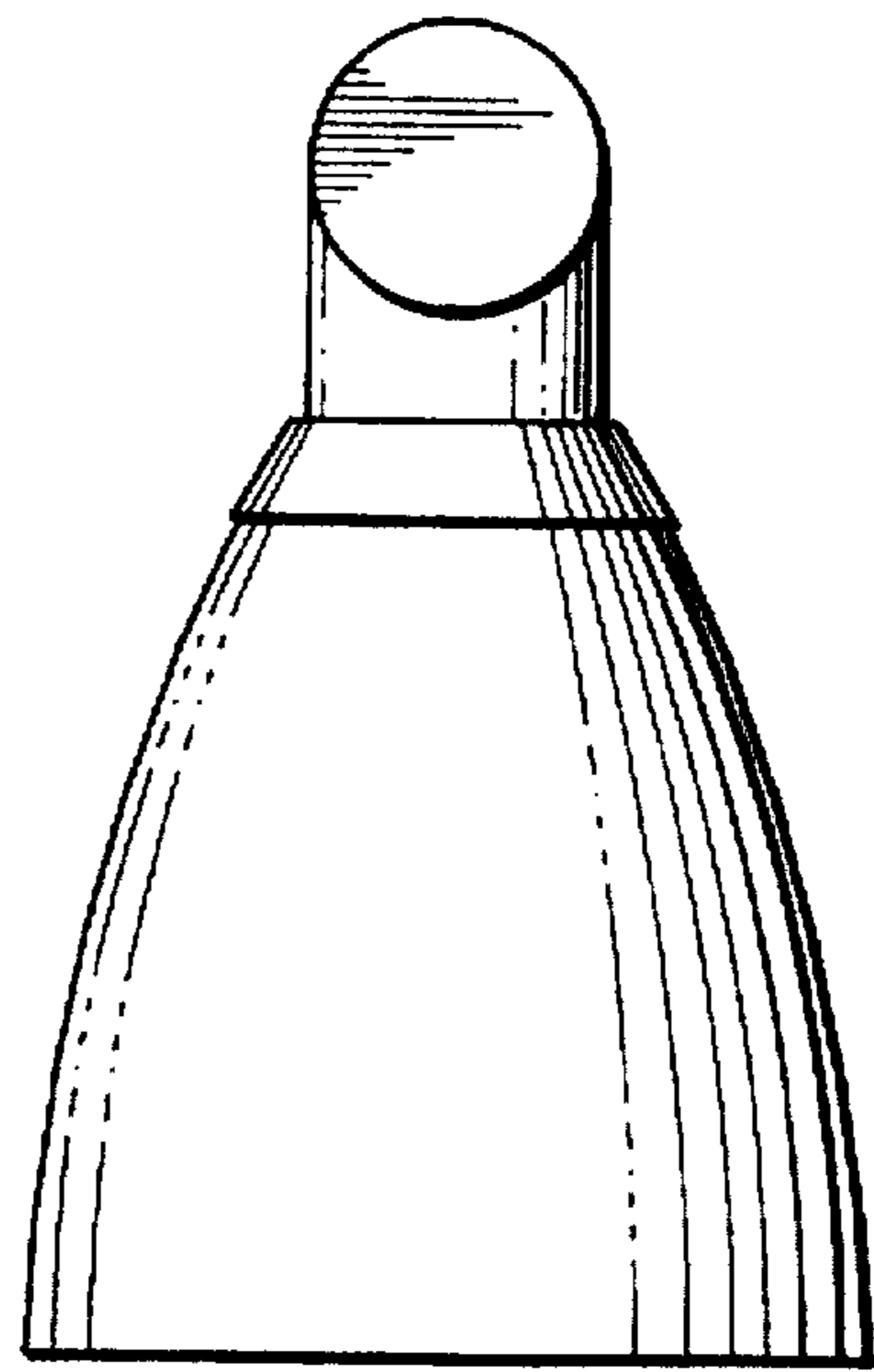

FIG. 5

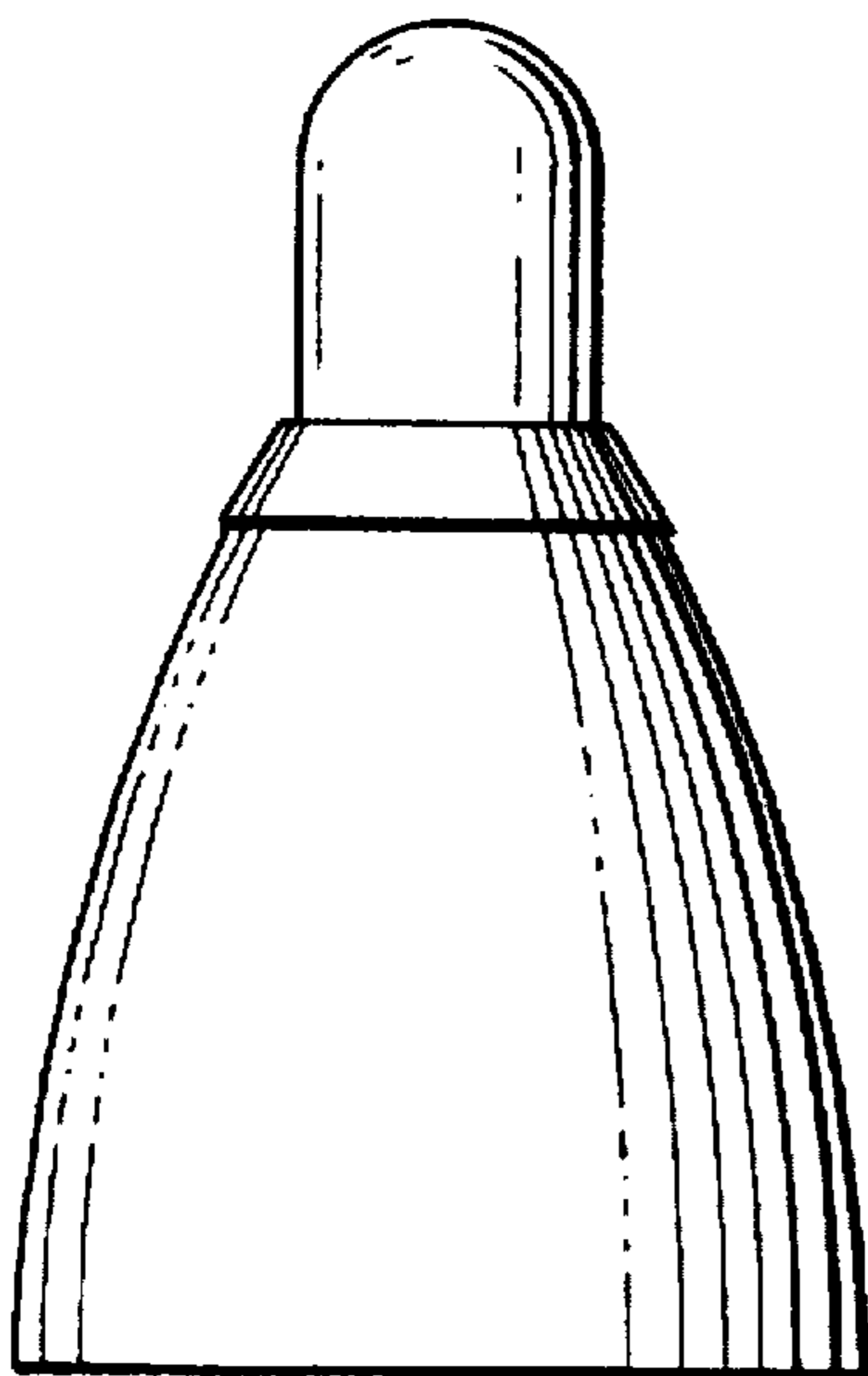

FIG. 6