



US00D395777S

United States Patent [19]

Belokin et al.

[11] Patent Number: **Des. 395,777**

[45] Date of Patent: ****Jul. 7, 1998**

[54] **COSMETICS RACK**

1,069,411 8/1913 Greene 211/87 X
2,568,405 9/1951 O'Malley 211/87 X

[76] Inventors: **Paul Belokin; Martin P. Belokin**, both of 7801 I-35 North, Denton, Tex. 76202; **Norman P. Belokin**, 3341 Evers Pkwy., Denton, Tex. 76207

Primary Examiner—Brian N. Vinson
Attorney, Agent, or Firm—Jack A. Kanz

[**] Term: **14 Years**

[57] **CLAIM**

The ornamental design for a cosmetics rack, as shown and described.

[21] Appl. No.: **78,172**

[22] Filed: **Oct. 20, 1997**

DESCRIPTION

[51] **LOC (6) Cl.** **08-08**

[52] **U.S. Cl.** **D6/567**

[58] **Field of Search** D6/552, 553, 567, D6/569; 211/60.1, 69.1, 69.5, 71, 86, 87

FIG. 1 is a front perspective view of a cosmetics rack showing our new design;

FIG. 2 is a side elevational view thereof, the opposite side view being a mirror image of the view of FIG. 2;

FIG. 3 is a top plan view thereof;

FIG. 4 is a rear elevation view thereof; and,

FIG. 5 is a bottom plan view of our cosmetics rack.

[56] **References Cited**

U.S. PATENT DOCUMENTS

347,866 9/1886 Jones et al. 211/87 X

1 Claim, 3 Drawing Sheets

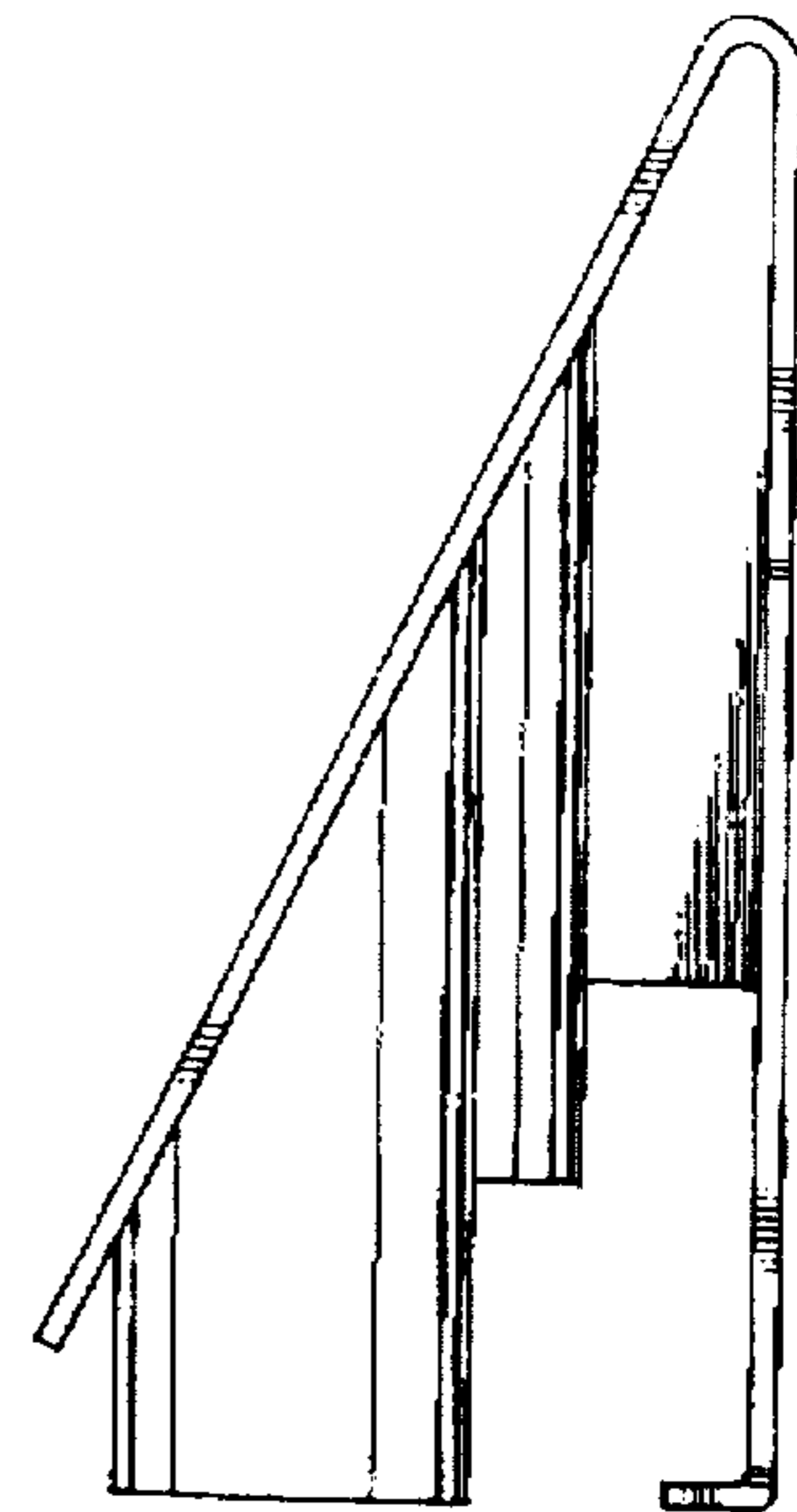
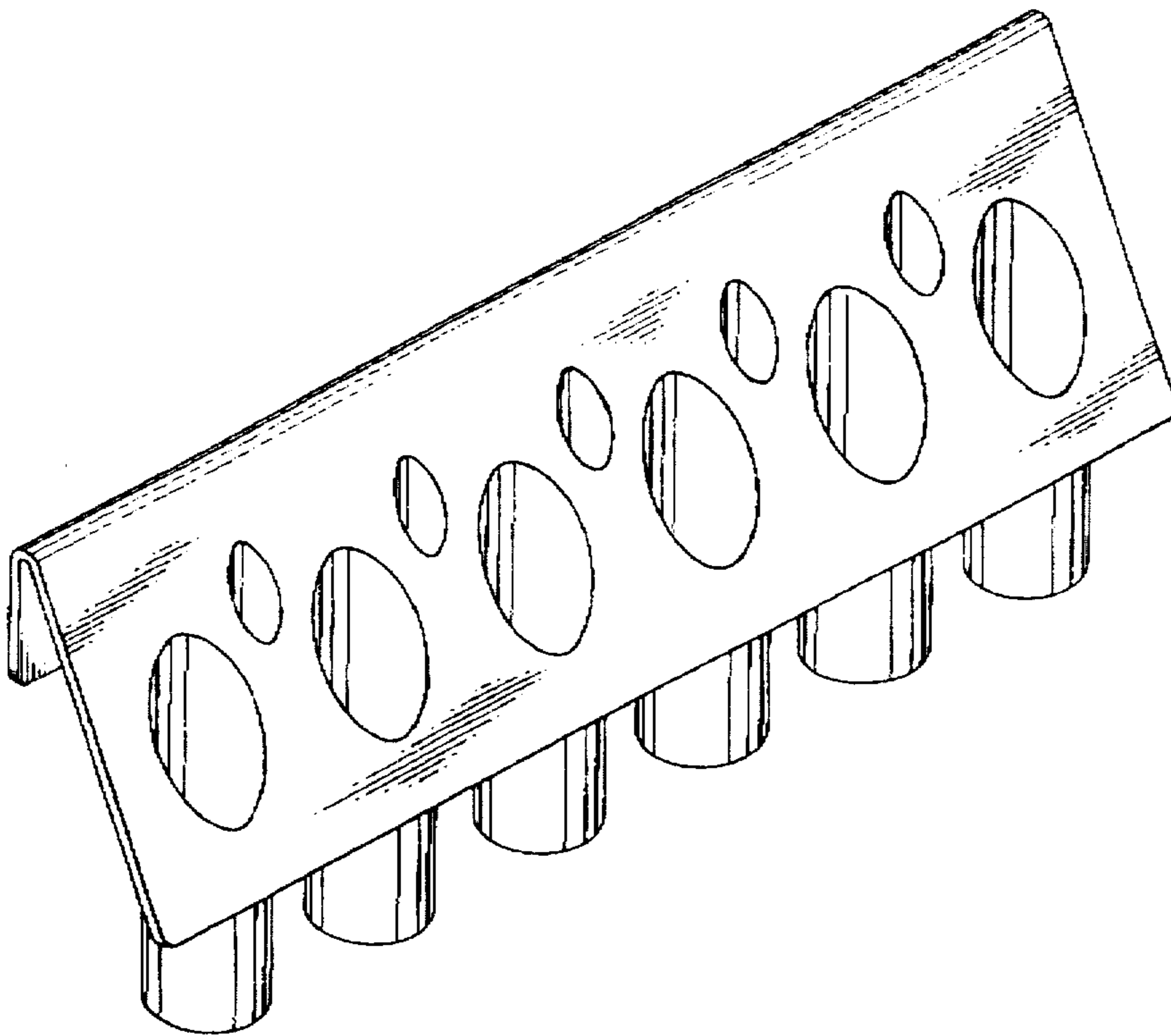

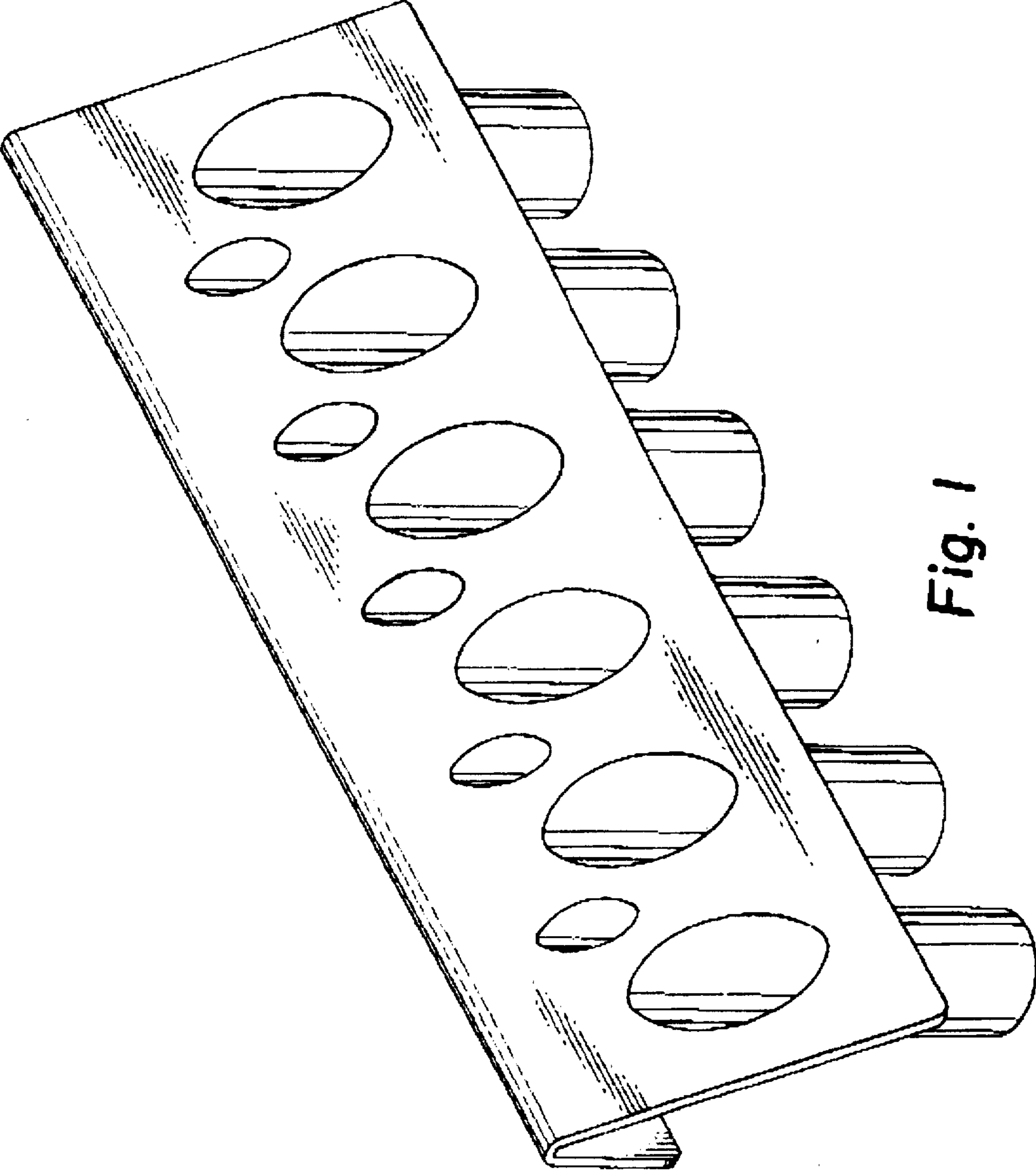

Fig. 1

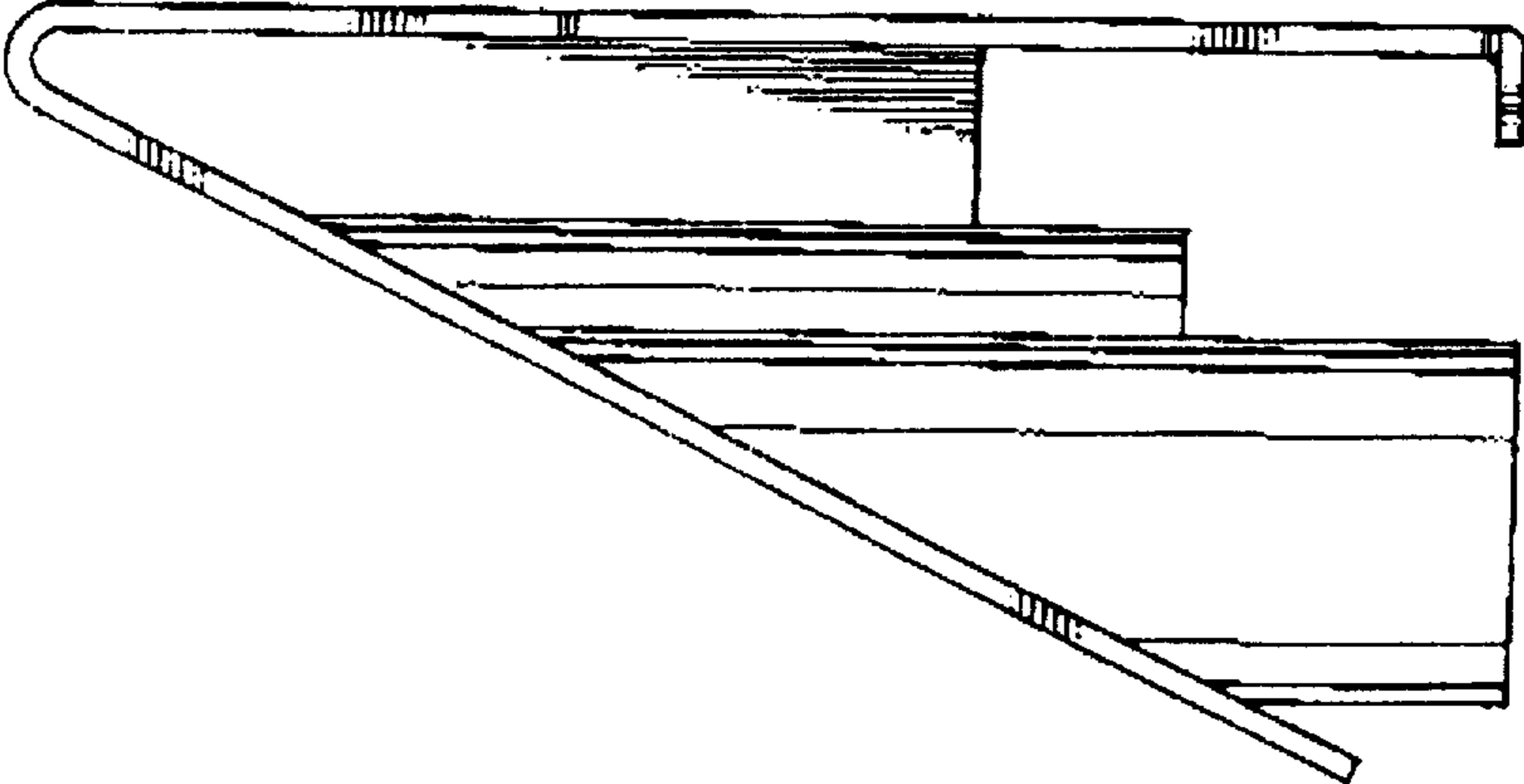

Fig. 2

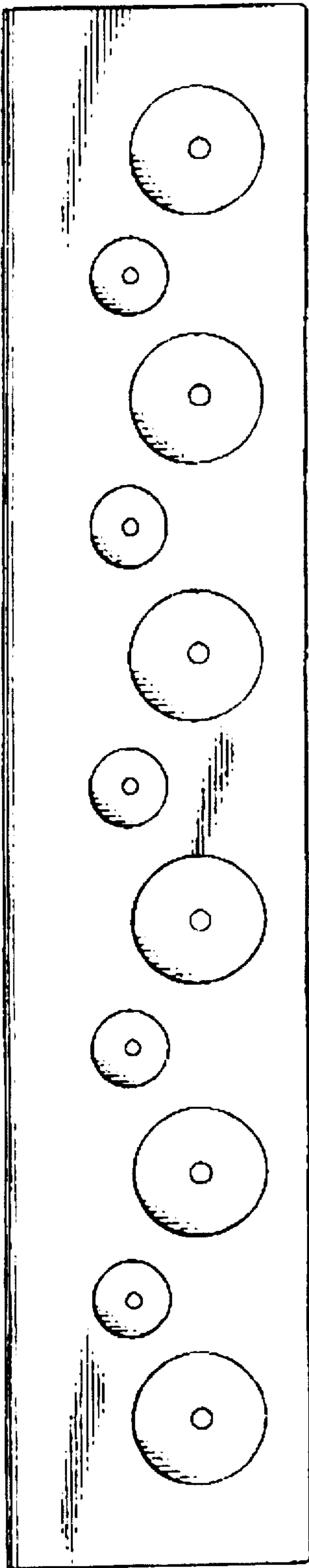

Fig. 3

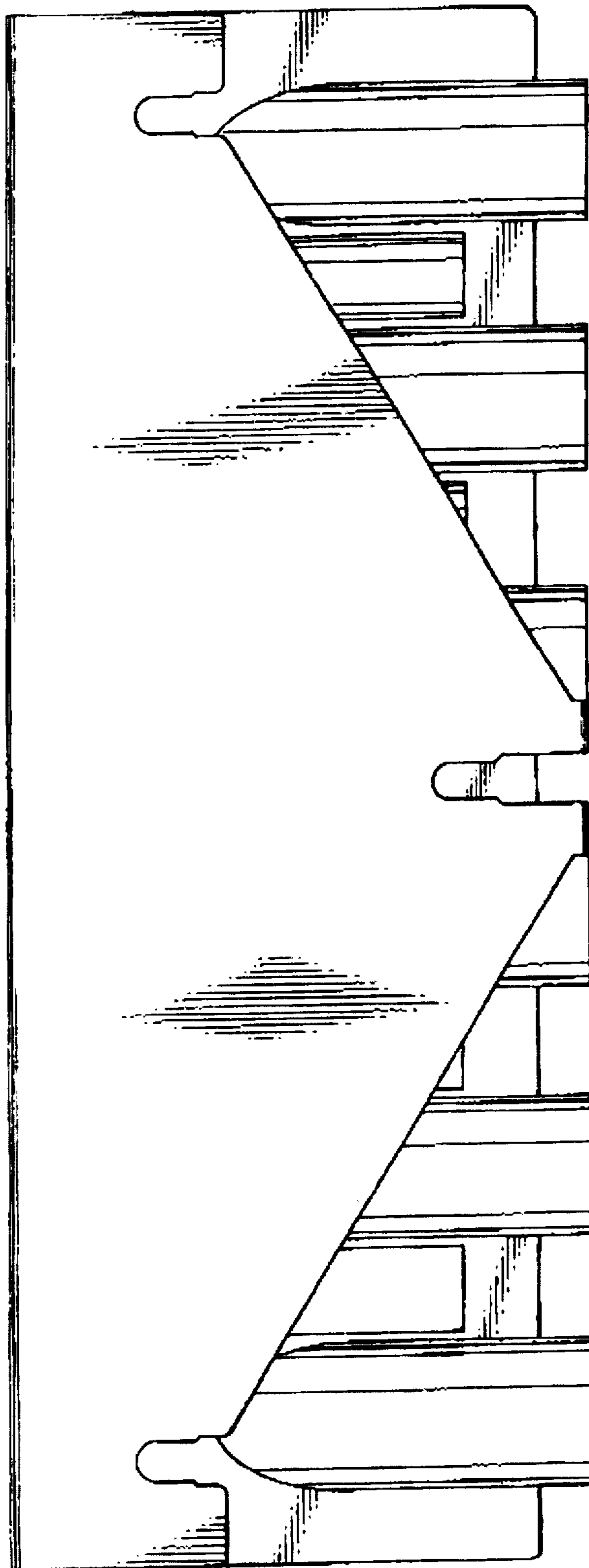

Fig. 4

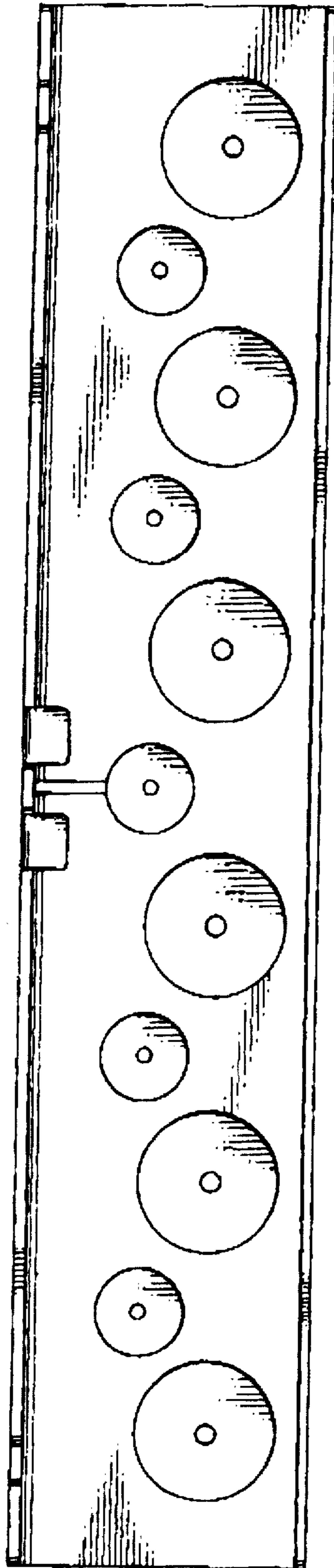

Fig. 5