



US00D395686S

United States Patent [19]
Eckmann

[11] **Patent Number: Des. 395,686**

[45] **Date of Patent: **Jun. 30, 1998**

[54] **HAND AND WRIST WEIGHT**

[75] Inventor: **James A. Eckmann**, Libertyville, Ill.

[73] Assignee: **Sportworks Ltd.**, Vernon Hills, Ill.

[**] Term: **14 Years**

[21] Appl. No.: **62,508**

[22] Filed: **Nov. 18, 1996**

[51] **LOC (6) Cl.** **21-02**

[52] **U.S. Cl.** **D21/196**

[58] **Field of Search** D21/196, 191,
D21/197, 198; 482/105, 106, 108, 109;
D29/120

[56] **References Cited**

U.S. PATENT DOCUMENTS

D. 200,415	2/1965	Tarbox	D21/196
D. 348,090	6/1994	Riley, Jr.	D21/196
D. 370,510	6/1996	Kissin et al.	D21/196
4,330,120	5/1982	Netti	482/105
4,556,215	12/1985	Tarbox et al.	482/105
4,575,075	3/1986	Tarbox et al.	482/105
4,585,228	4/1986	Olson	482/105
4,813,079	3/1989	Reitzel	482/105
4,923,418	5/1990	Hoffman	482/105
5,004,227	4/1991	Hoffman	482/105
5,300,000	4/1994	Schwartz	482/105

Primary Examiner—Philip S. Hyder
Attorney, Agent, or Firm—Polster, Lieder, Woodruff & Lucchesi, LC.

[57] **CLAIM**

The ornamental design for a hand and wrist weight, as shown and described.

DESCRIPTION

FIG. 1 is view in perspective of one embodiment of weight of this invention, as worn;

FIG. 2 is another view in perspective of the weight of FIG. 1;

FIG. 3 is a third view in perspective of the weight shown in FIGS. 1 and 2;

FIG. 4 is a fourth view in perspective of the device shown in FIGS. 1-3;

FIG. 5 is a view in perspective on the other side of the hand of a wearer, of the device shown in FIGS. 1-4;

FIG. 6 is a top plan view of a second embodiment;

FIG. 7 is a bottom plan view of the device shown in FIG. 6;

FIG. 8 is a view in end elevation in the direction from top to bottom of FIG. 6;

FIG. 9 is a view in end elevation in the direction from bottom to top of FIG. 6;

FIG. 10 is a view in end elevation view from top to bottom of FIG. 12;

FIG. 11 is a view in end elevation viewed from bottom to top of FIG. 12;

FIG. 12 is a top plan view of the first embodiment of a weight, unmounted;

FIG. 13 is a bottom plan view of the weight shown in FIG. 12;

FIG. 14 is a view in side elevation, viewed from left to right, of FIG. 6;

FIG. 15 is a view in side elevation, viewed from right to left, of FIG. 6;

FIG. 16 is a view in side elevation, viewed from right to left, of FIG. 12; and,

FIG. 17 is a view in side elevation from left to right of FIG. 12, a buckle being obscured by the raised margin of the weight, as shown in FIG. 12.

The broken line showing of the hand and wrist is for illustrative purposes only and forms no part of the claimed design.

1 Claim, 6 Drawing Sheets

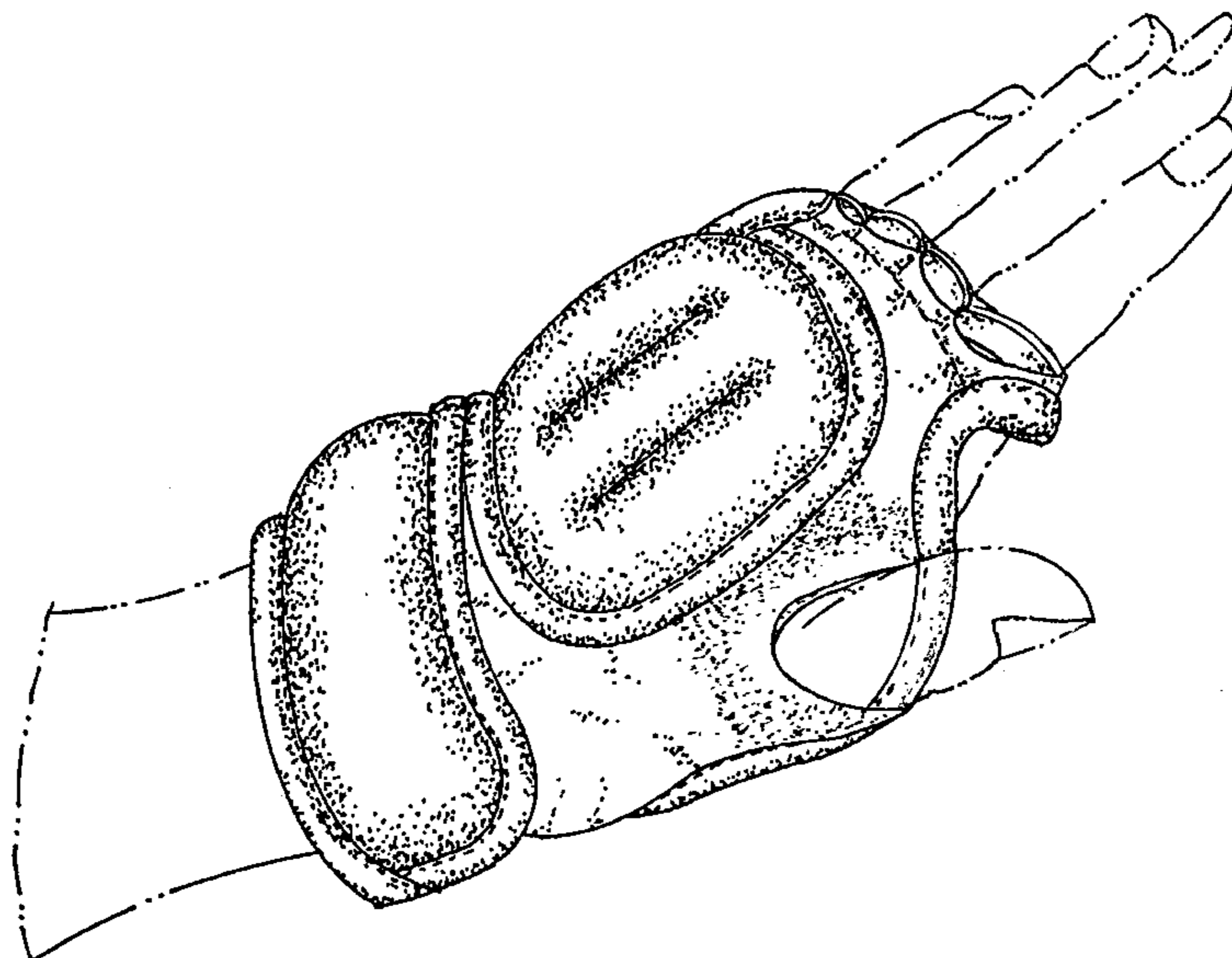

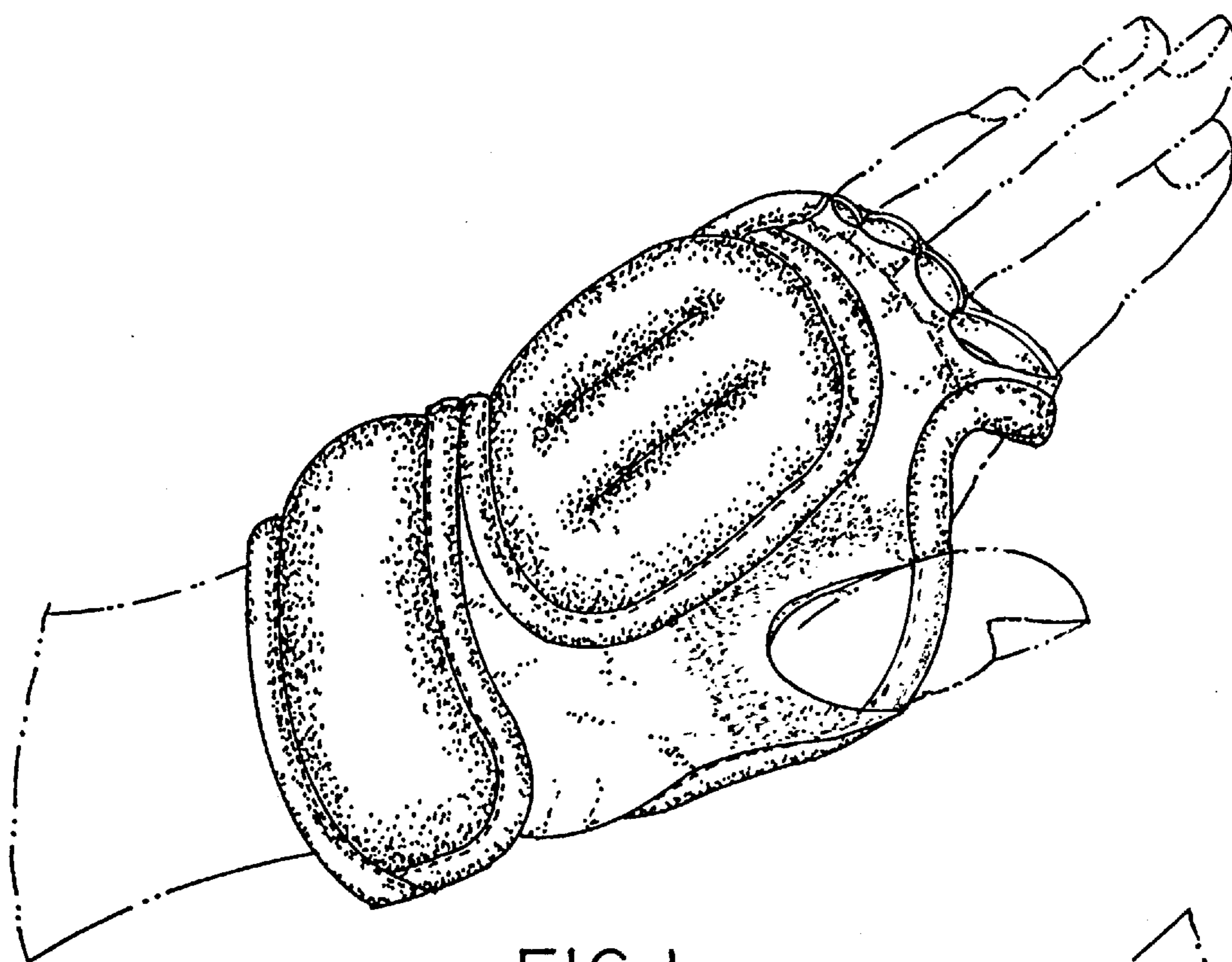

FIG. 1

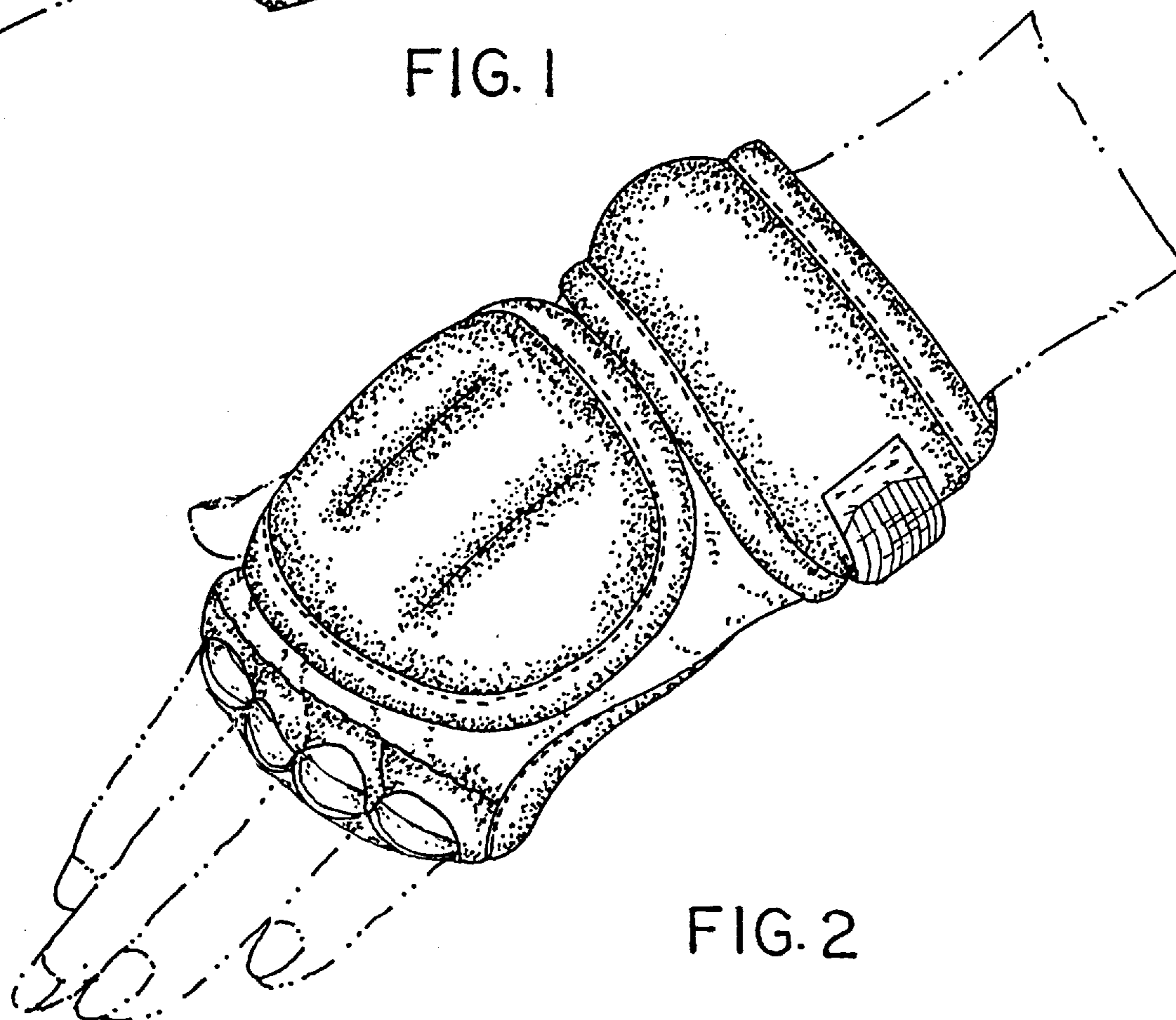

FIG. 2

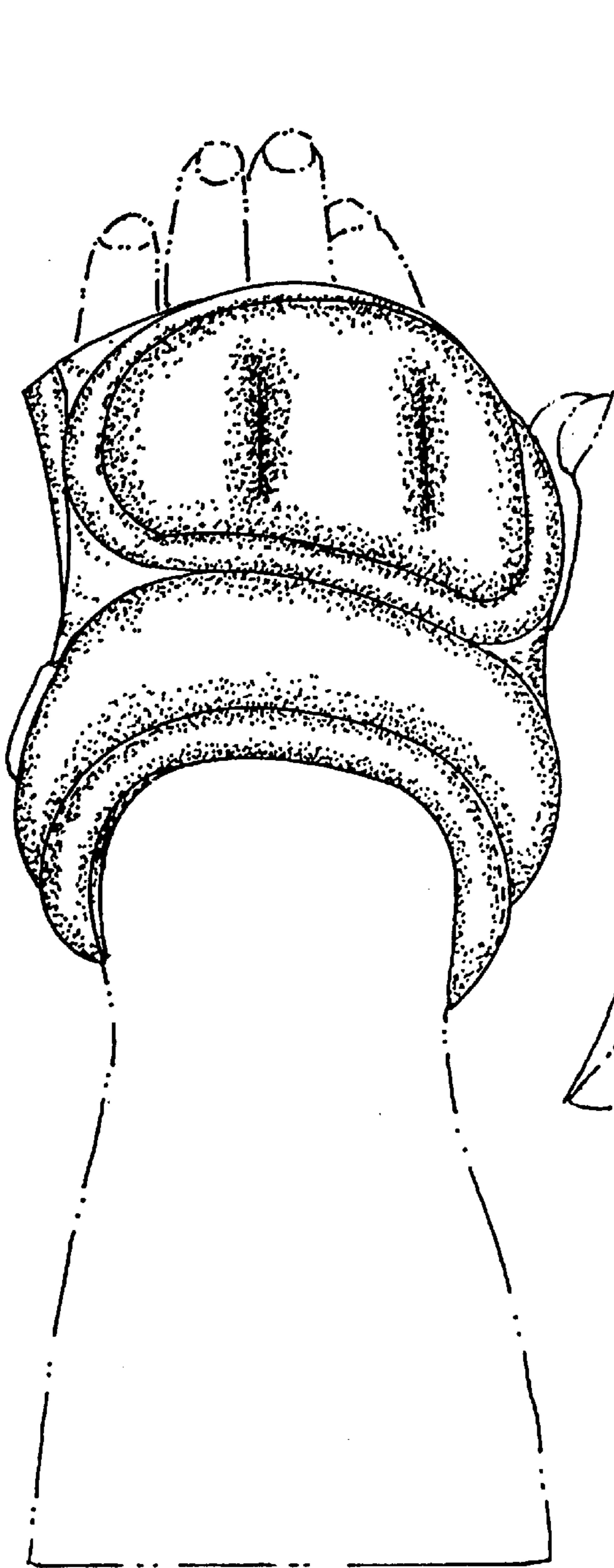

FIG. 3

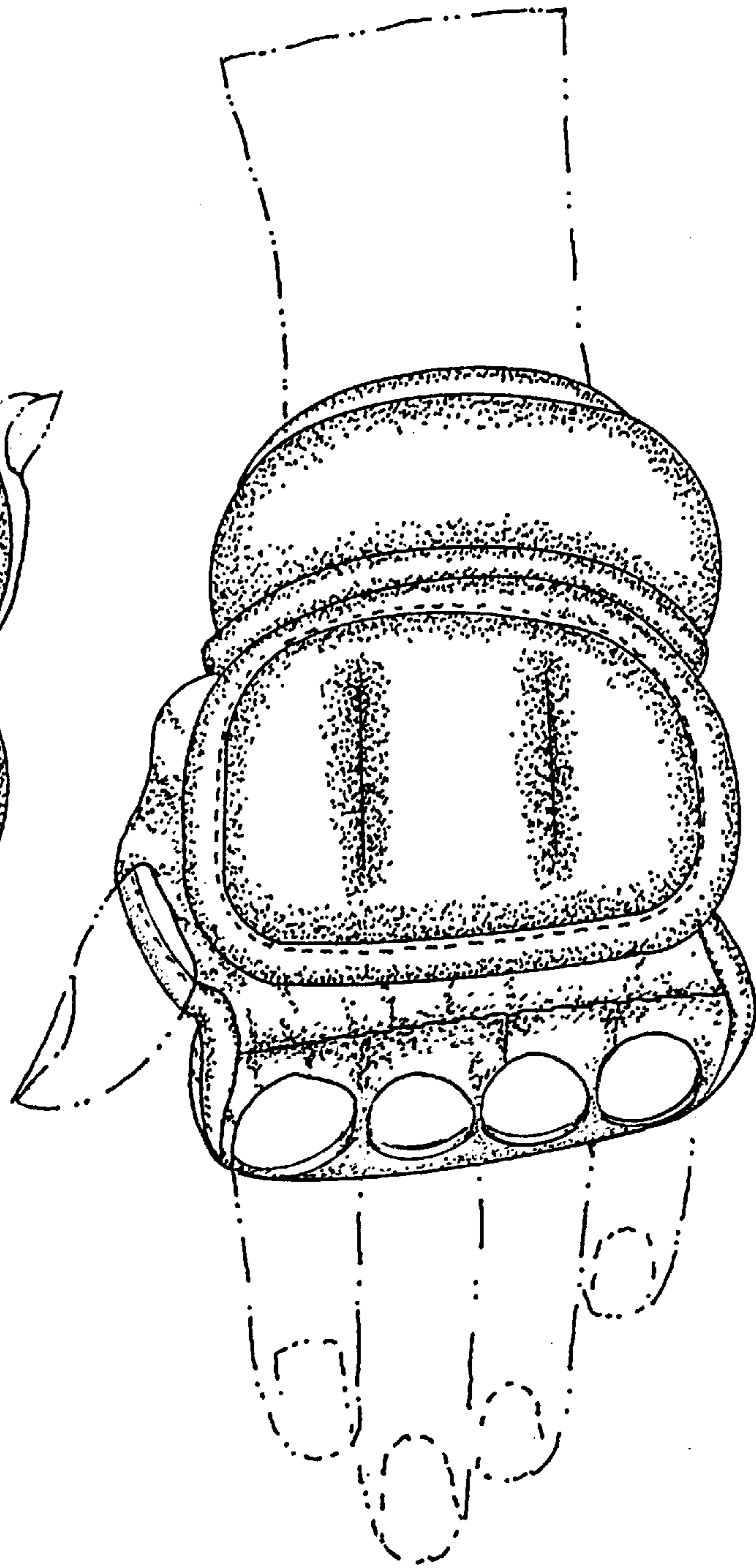

FIG. 4

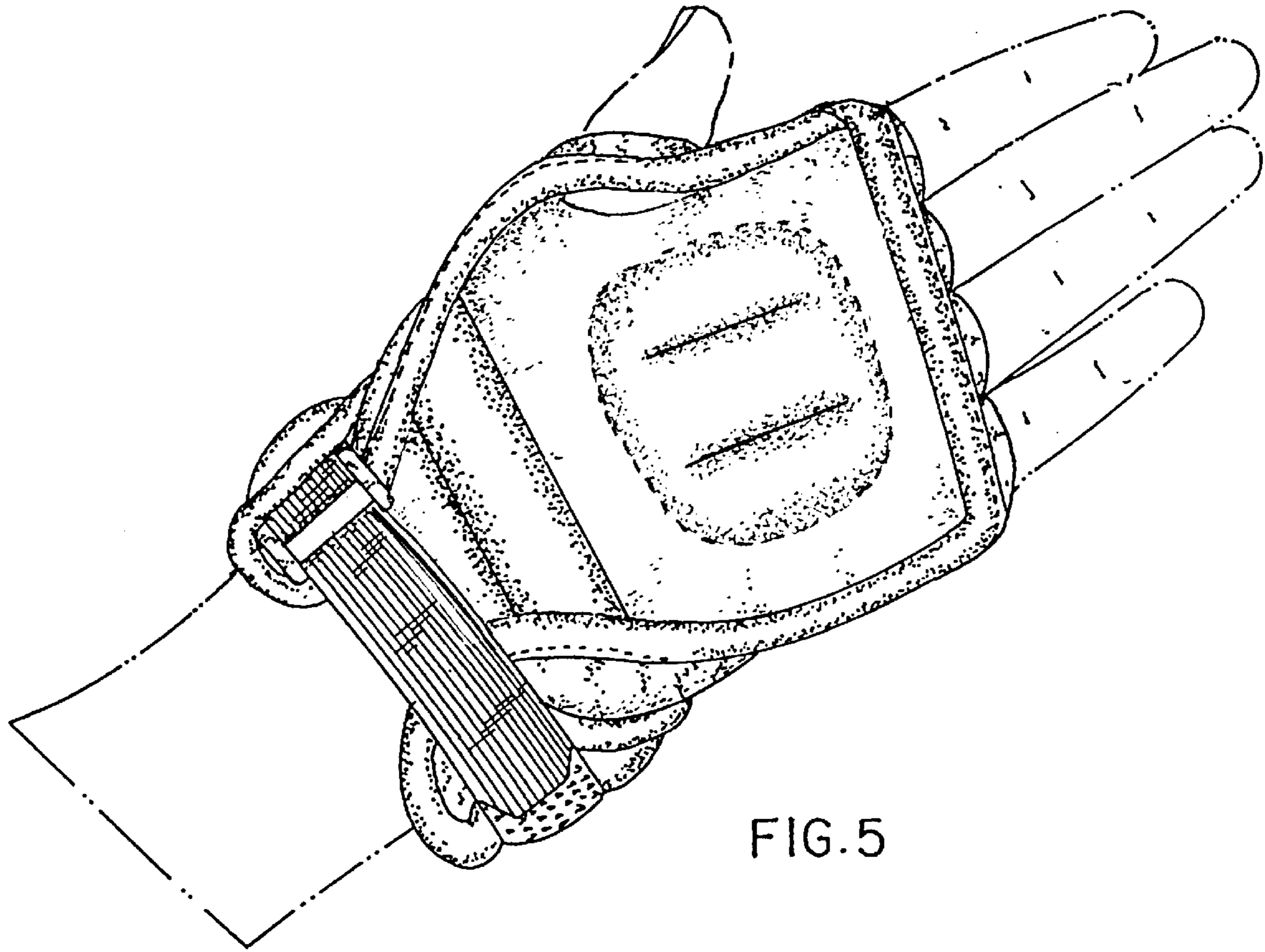

FIG. 5

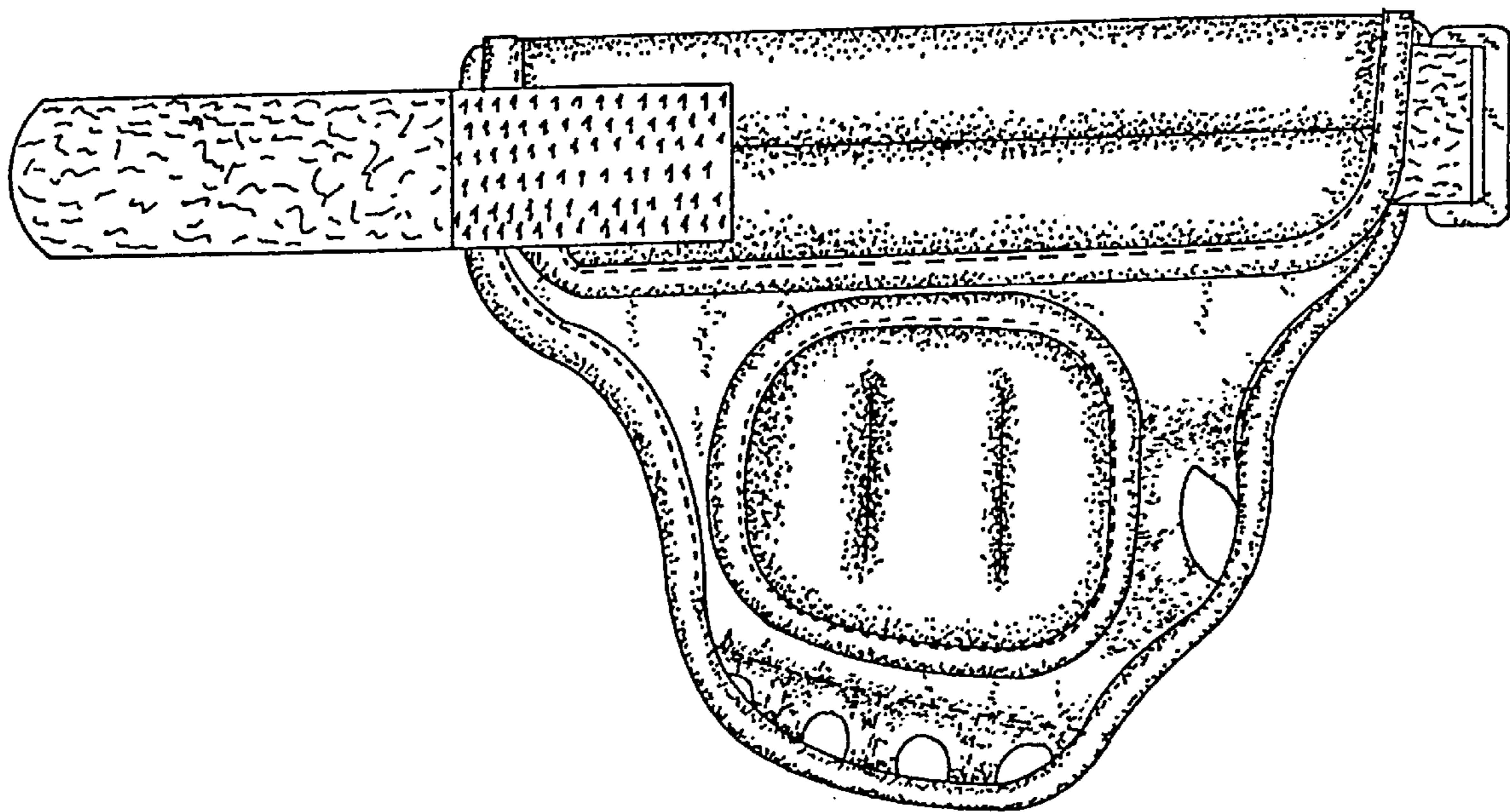

FIG. 6

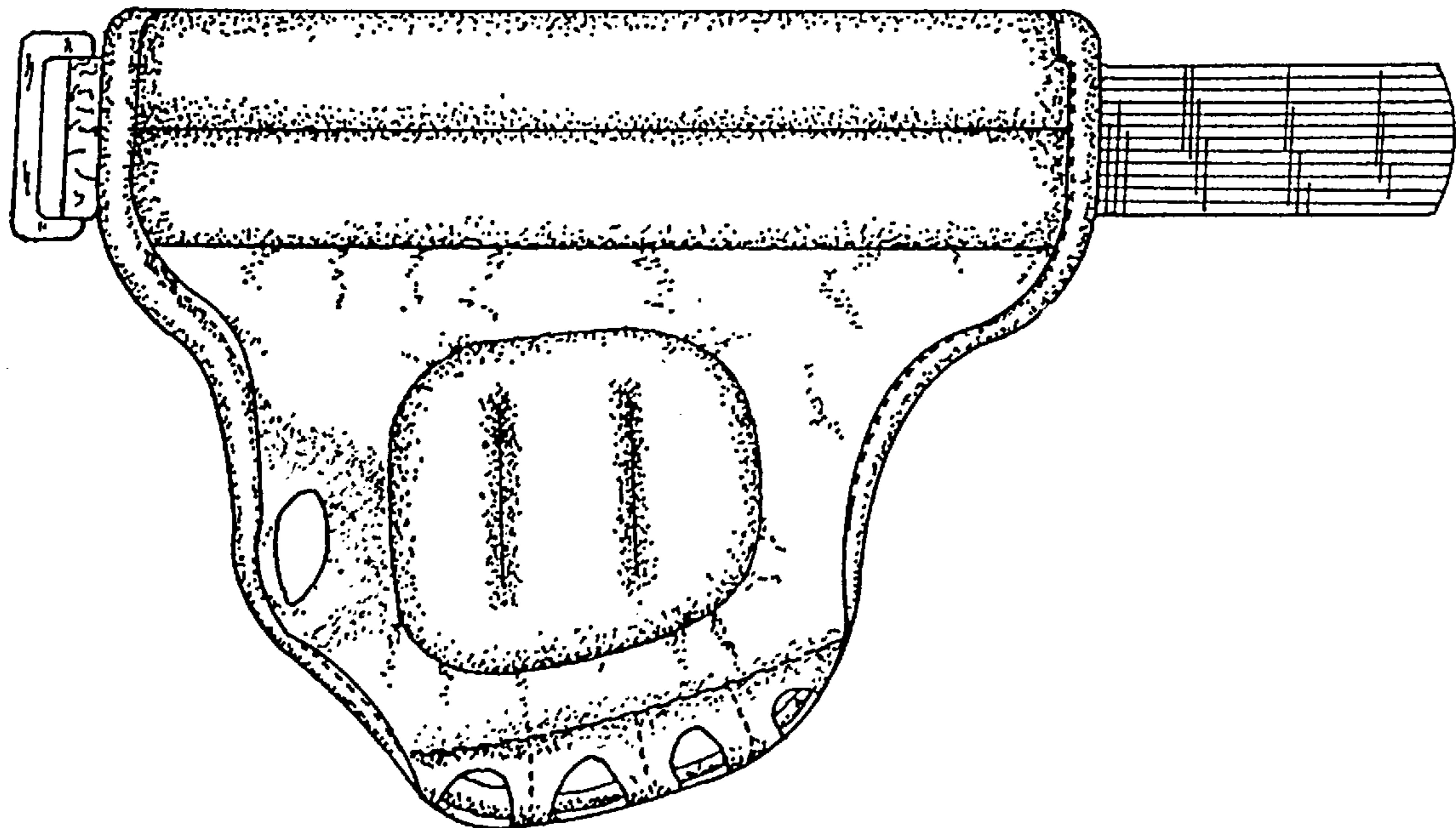

FIG. 7

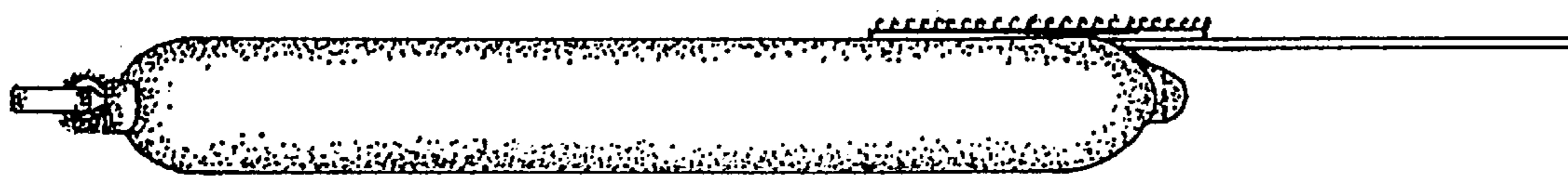

FIG. 8

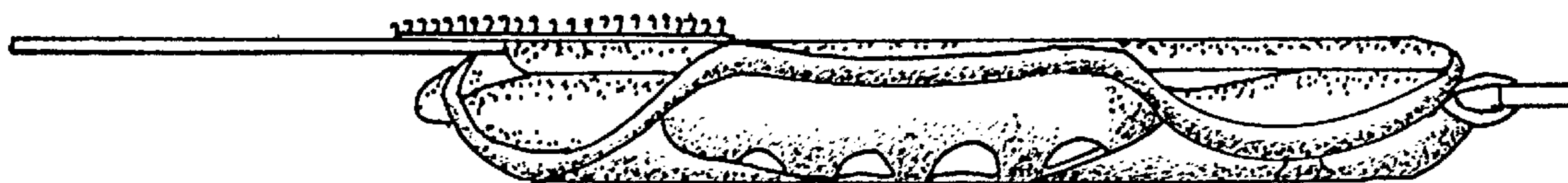

FIG. 9

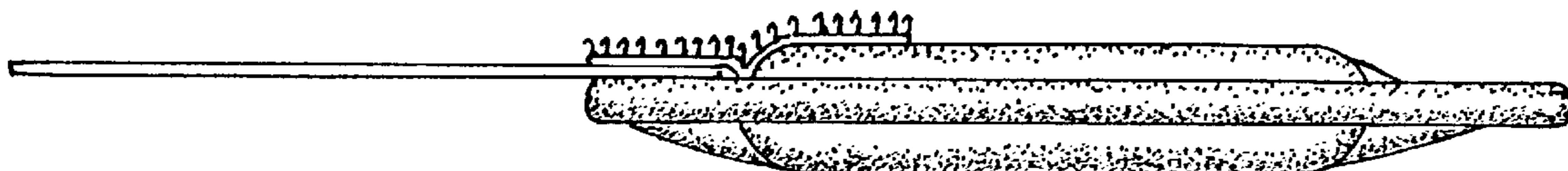

FIG. 10

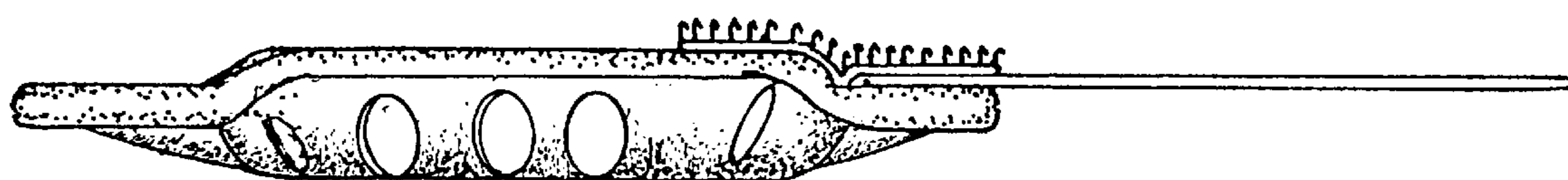

FIG. 11

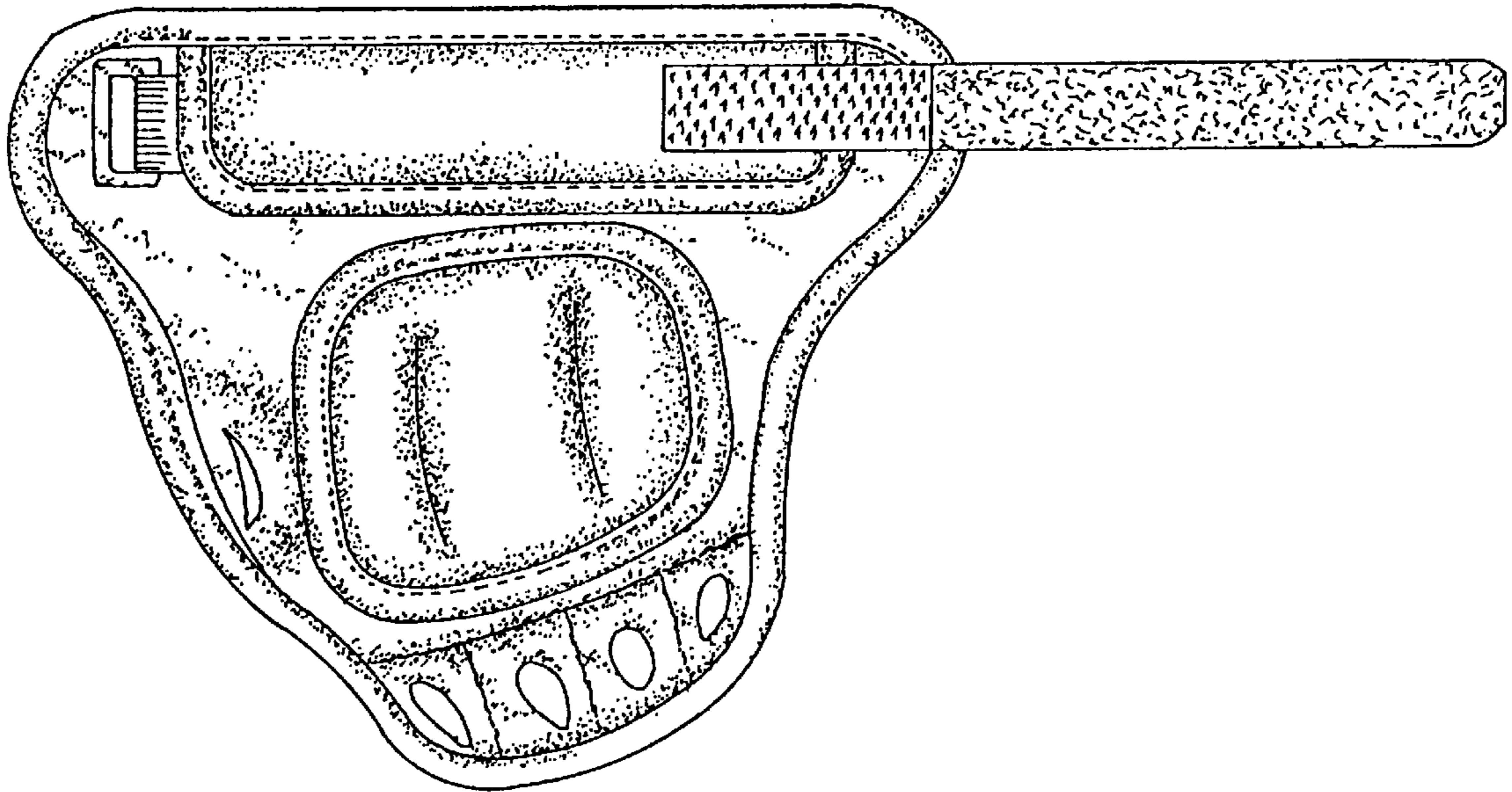

FIG. 12

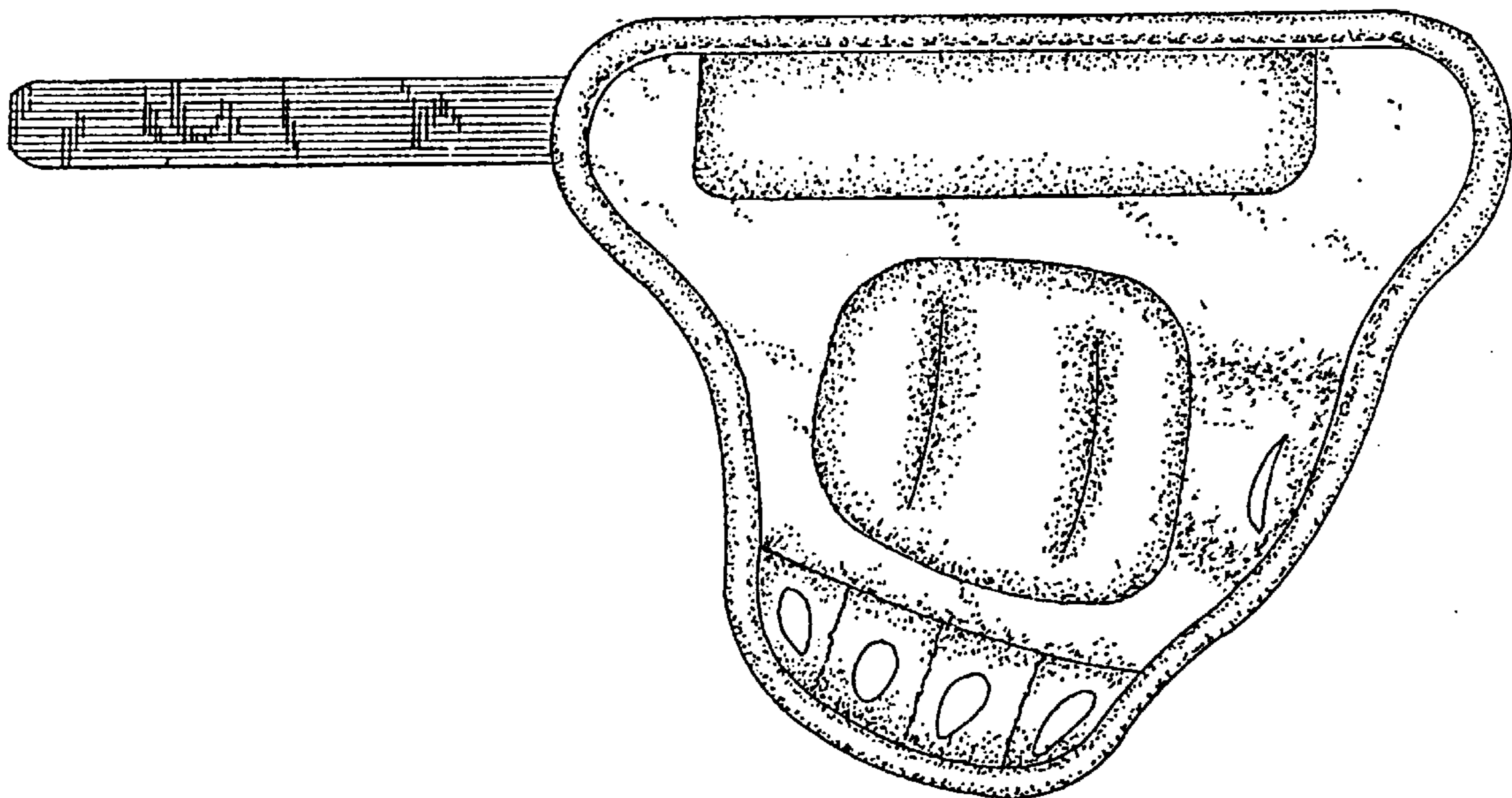

FIG. 13

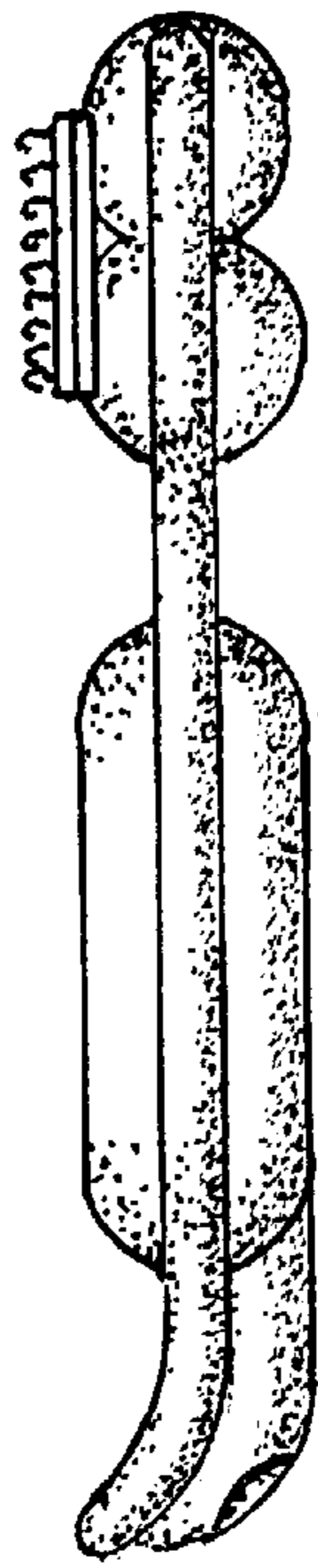

FIG. 14

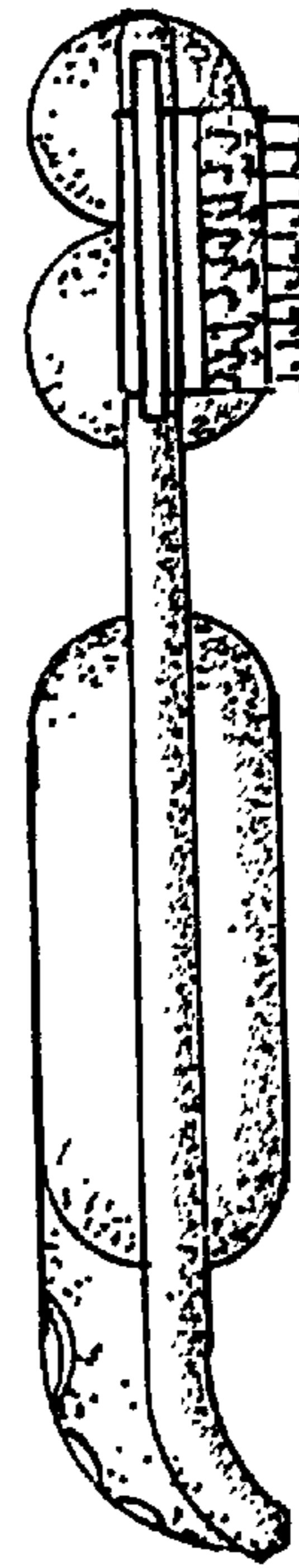

FIG. 15



FIG. 16

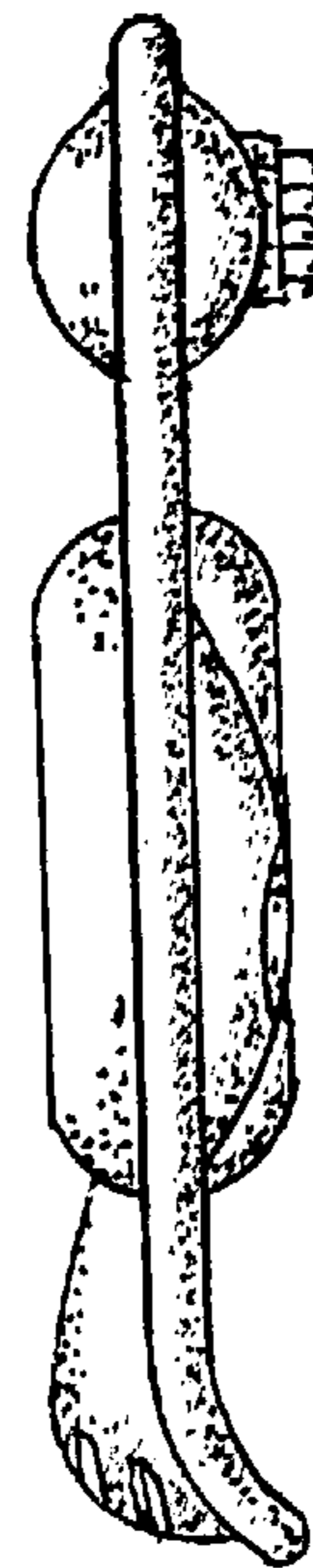

FIG. 17