

US00D395495S

United States Patent [19]

Wu

[11] Patent Number: **Des. 395,495**

[45] Date of Patent: ****Jun. 23, 1998**

[54] **SMOKE EXHAUSTER**

5,469,837 11/1995 Chiang et al. 126/299 R

[76] Inventor: **Min Wei Wu**, No. 95-10, Chang Ping Rd., Sec. 1, Taichung, Taiwan

Primary Examiner—Lisa Lichtenstein

[**] Term: **14 Years**

[57] **CLAIM**

The ornamental design for a smoke exhauster, as shown and described.

[21] Appl. No.: **63,176**

[22] Filed: **Dec. 2, 1996**

DESCRIPTION

[51] **LOC (6) Cl.** **23-04**

[52] **U.S. Cl.** **D23/372**

[58] **Field of Search** D23/371, 372, D23/370; 126/299 D, 299 R

FIG. 1 is a perspective view to my new design of a smoke exhauster;

FIG. 2 is a front side view of FIG. 1, on a reduced scale; FIG. 3 is a left side view, on a reduced scale (symmetric to its right side view);

FIG. 4 is a top view of FIG. 1, on a reduced scale;

FIG. 5 is a bottom view of FIG. 1, on a reduced scale; and,

FIG. 6 is a rear side view of FIG. 1, on a reduced scale.

[56] **References Cited**

U.S. PATENT DOCUMENTS

- D. 325,966 5/1992 Wei D23/372
- D. 327,541 6/1992 Chen D23/372

1 Claim, 3 Drawing Sheets

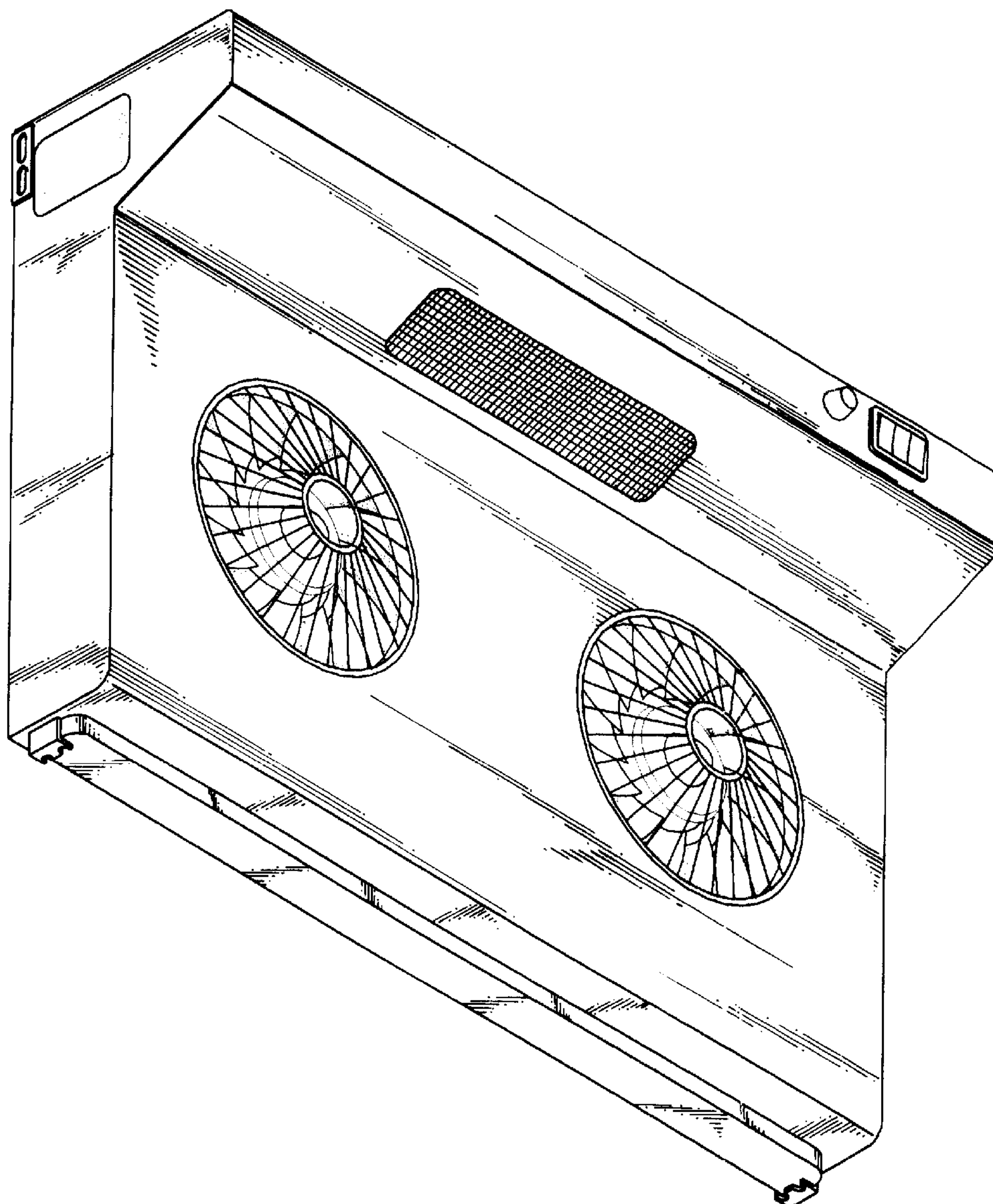

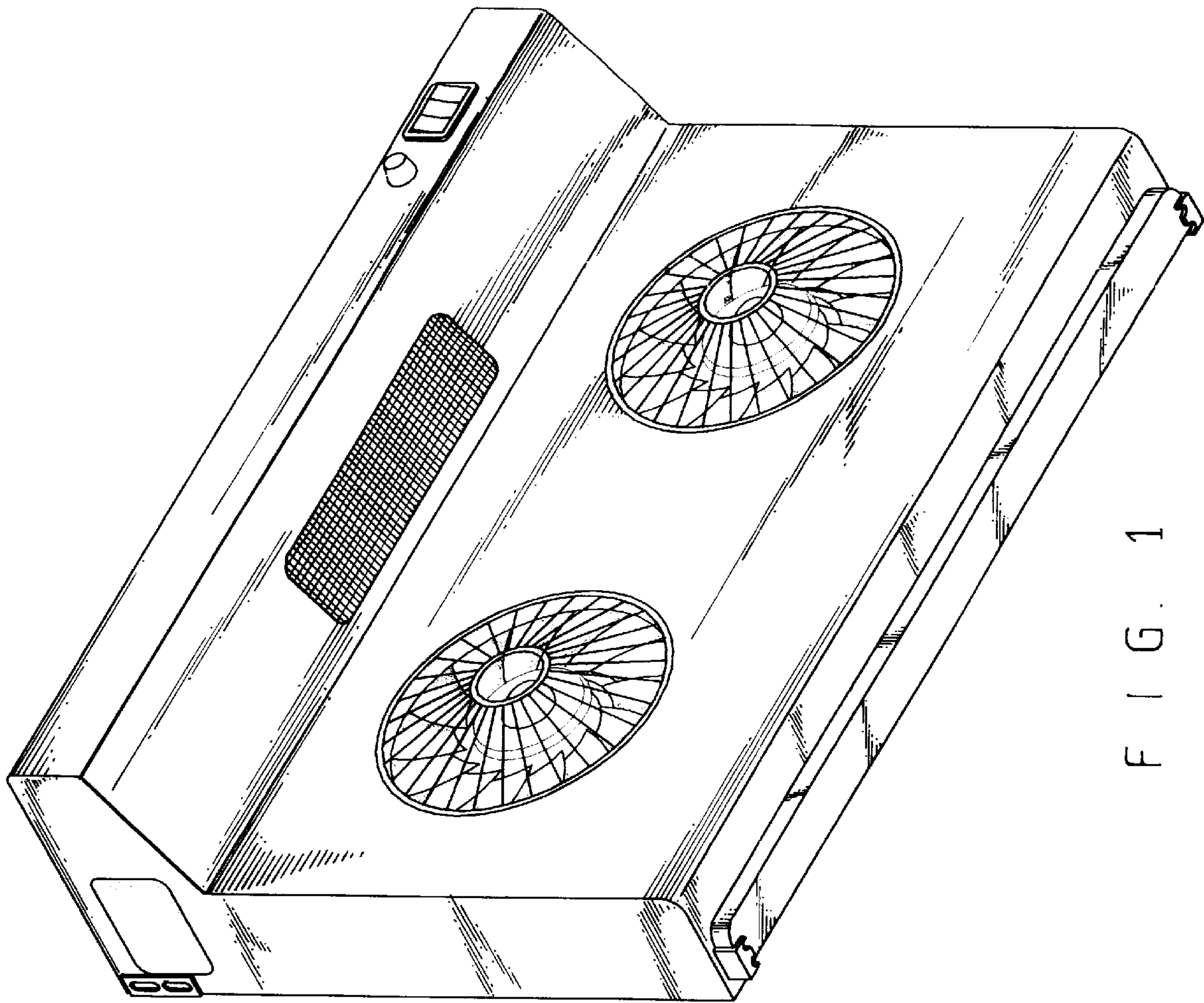

FIG. 1

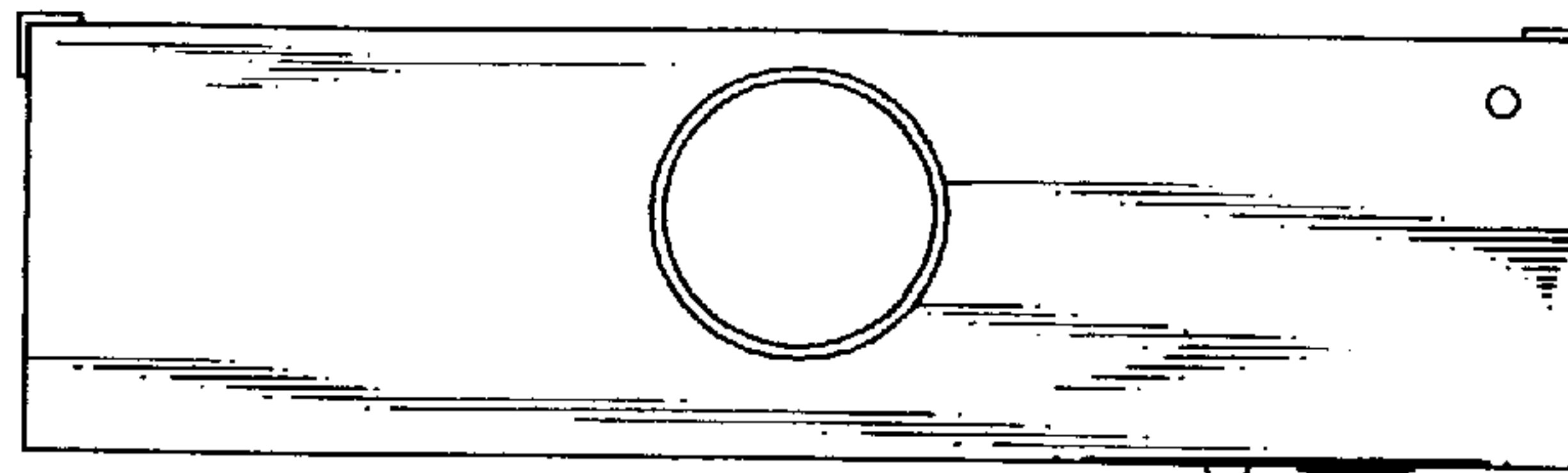

FIG. 4

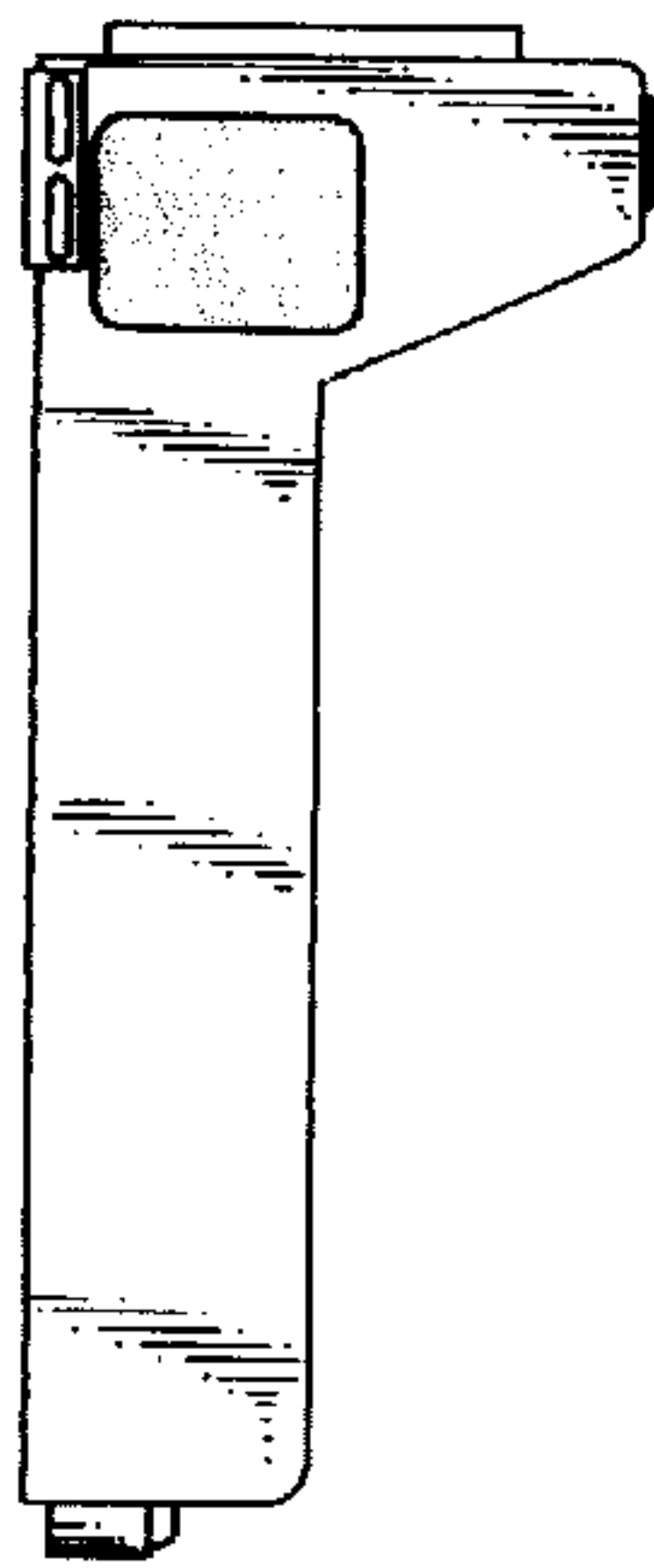

FIG. 3

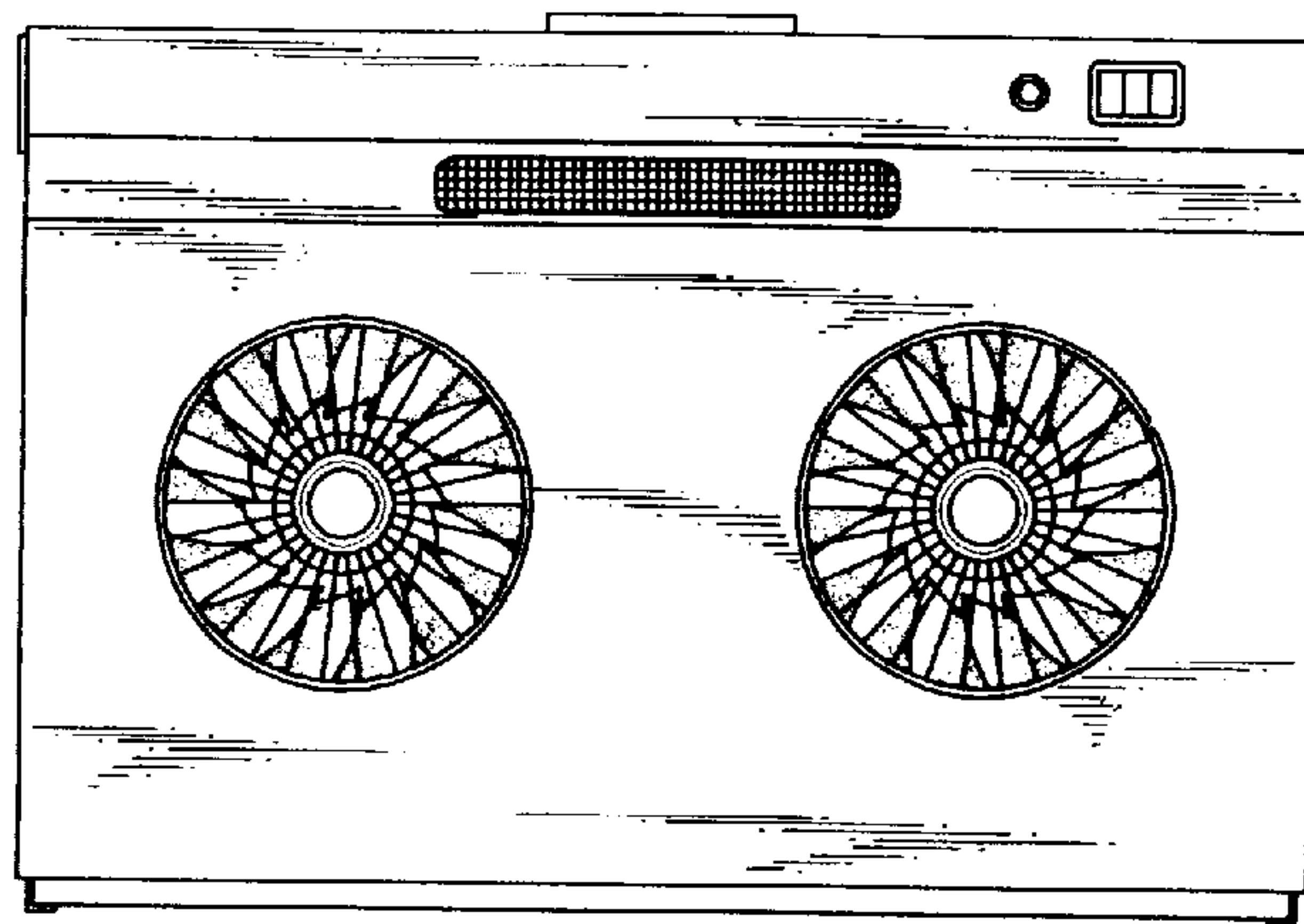

FIG. 2

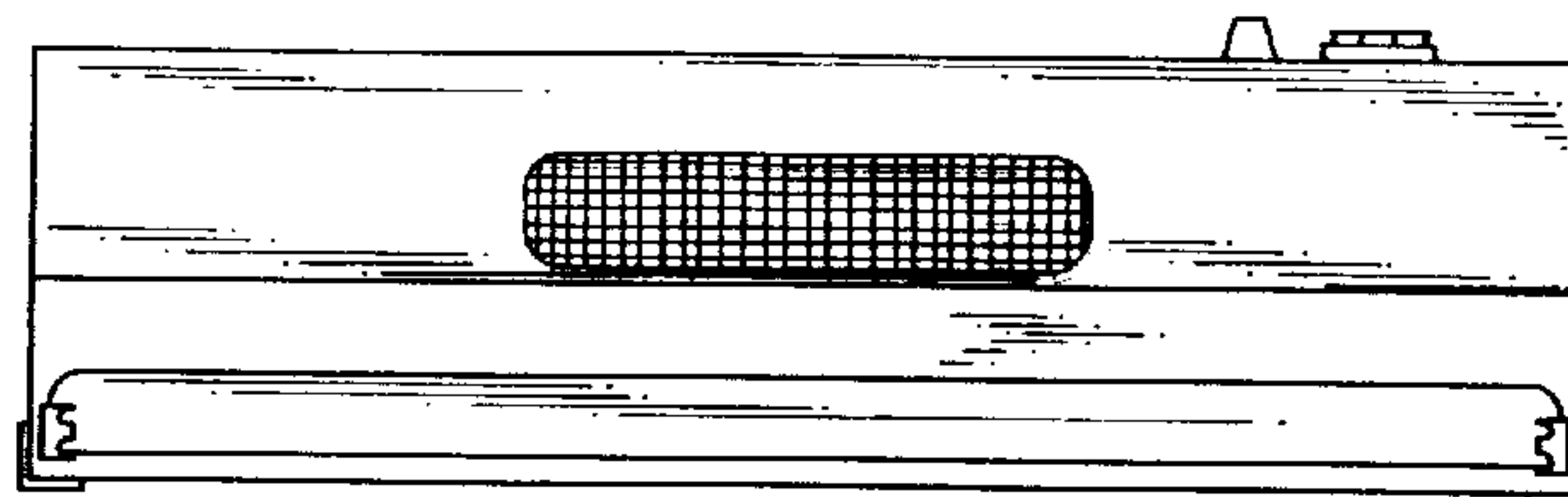
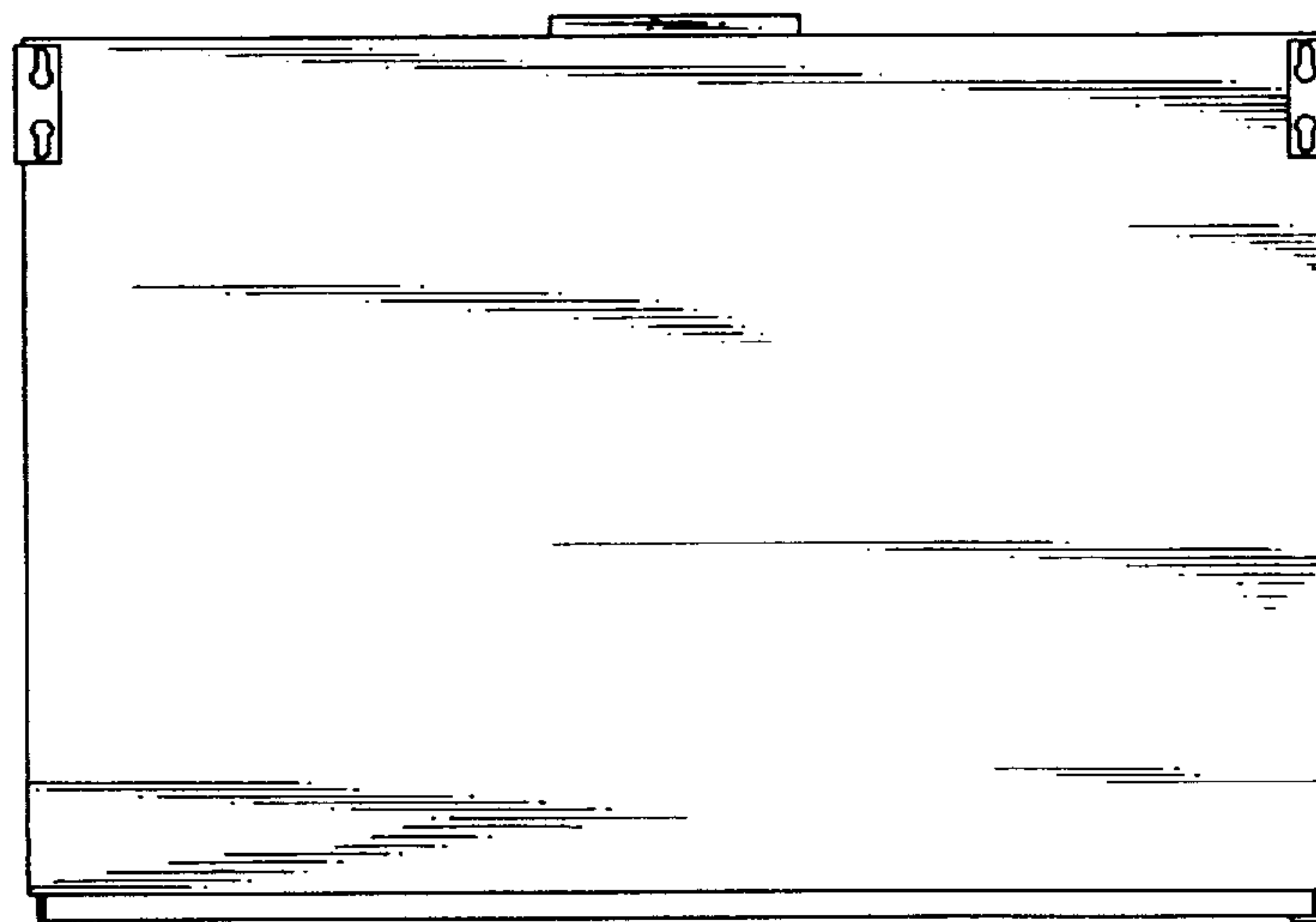

FIG. 5



F I G. 6