



US00D395452S

United States Patent [19]

[11] **Patent Number: Des. 395,452**

August

[45] **Date of Patent: **Jun. 23, 1998**

[54] **GUMBALL DISPENSER**

[76] Inventor: **Scott A. August**, 1703 Catalpa, Apt. #A, Royal Oak, Mich. 48067

[**] Term: **14 Years**

[21] Appl. No.: **67,858**

[22] Filed: **Apr. 7, 1997**

[51] **LOC (6) Cl. 20-01**

[52] **U.S. Cl. D20/7; D20/3**

[58] **Field of Search D21/240; D20/1, D20/3, 7; D11/157; D7/604, 606; D99/37; 194/350**

[56] **References Cited**

U.S. PATENT DOCUMENTS

| | | | | |
|------------|--------|---------------|-------|-----------|
| D. 218,349 | 8/1970 | Feeney | | D7/604 |
| D. 232,011 | 7/1974 | Denton | | D7/604 |
| D. 255,679 | 7/1980 | Thomas | | D21/240 X |
| D. 289,694 | 5/1987 | Pickett, Jr. | | D11/157 X |
| D. 314,492 | 2/1991 | Weller et al. | | D7/604 X |

| | | | | |
|------------|---------|--------|-------|---------|
| D. 321,845 | 11/1991 | Nys | | D11/157 |
| D. 356,427 | 3/1995 | August | | D99/37 |
| D. 379,023 | 4/1997 | August | | D99/37 |

Primary Examiner—Ted Shooman
Assistant Examiner—Mitchell I. Siegel
Attorney, Agent, or Firm—Arnold S. Weintraub

[57] **CLAIM**

The ornamental design for a gumball dispenser, as shown and described.

DESCRIPTION

FIG. 1 is a perspective view of a gumball dispenser showing my new design;
FIG. 2 is a first side elevational view thereof;
FIG. 3 is a rear elevational view thereof;
FIG. 4 is a second side elevational view hereof, as seen from the side opposite that of FIG. 2;
FIG. 5 is a front elevational view thereof;
FIG. 6 is a top plan view thereof; and,
FIG. 7 is a bottom plan view thereof.

1 Claim, 2 Drawing Sheets

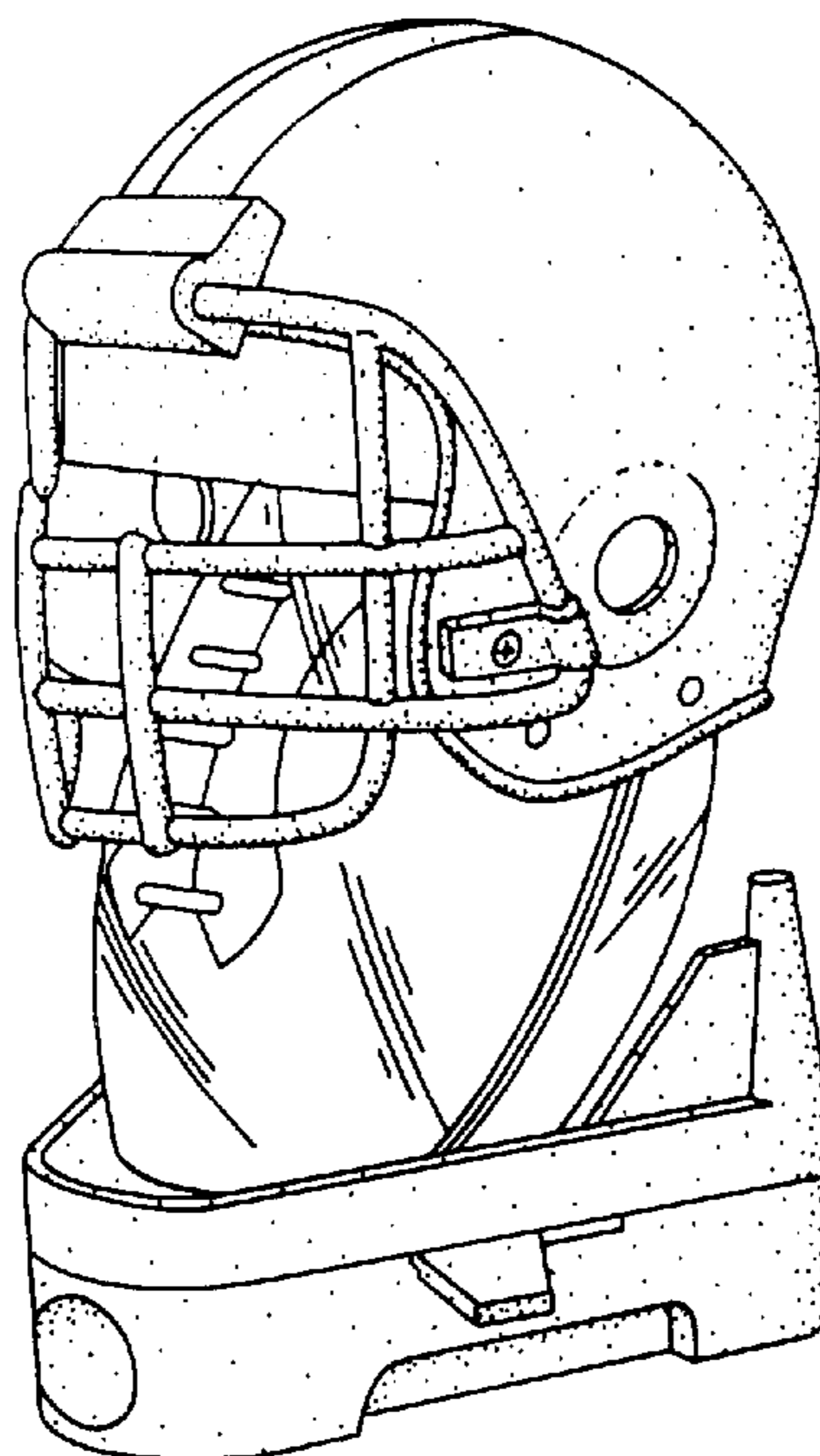

FIG 1

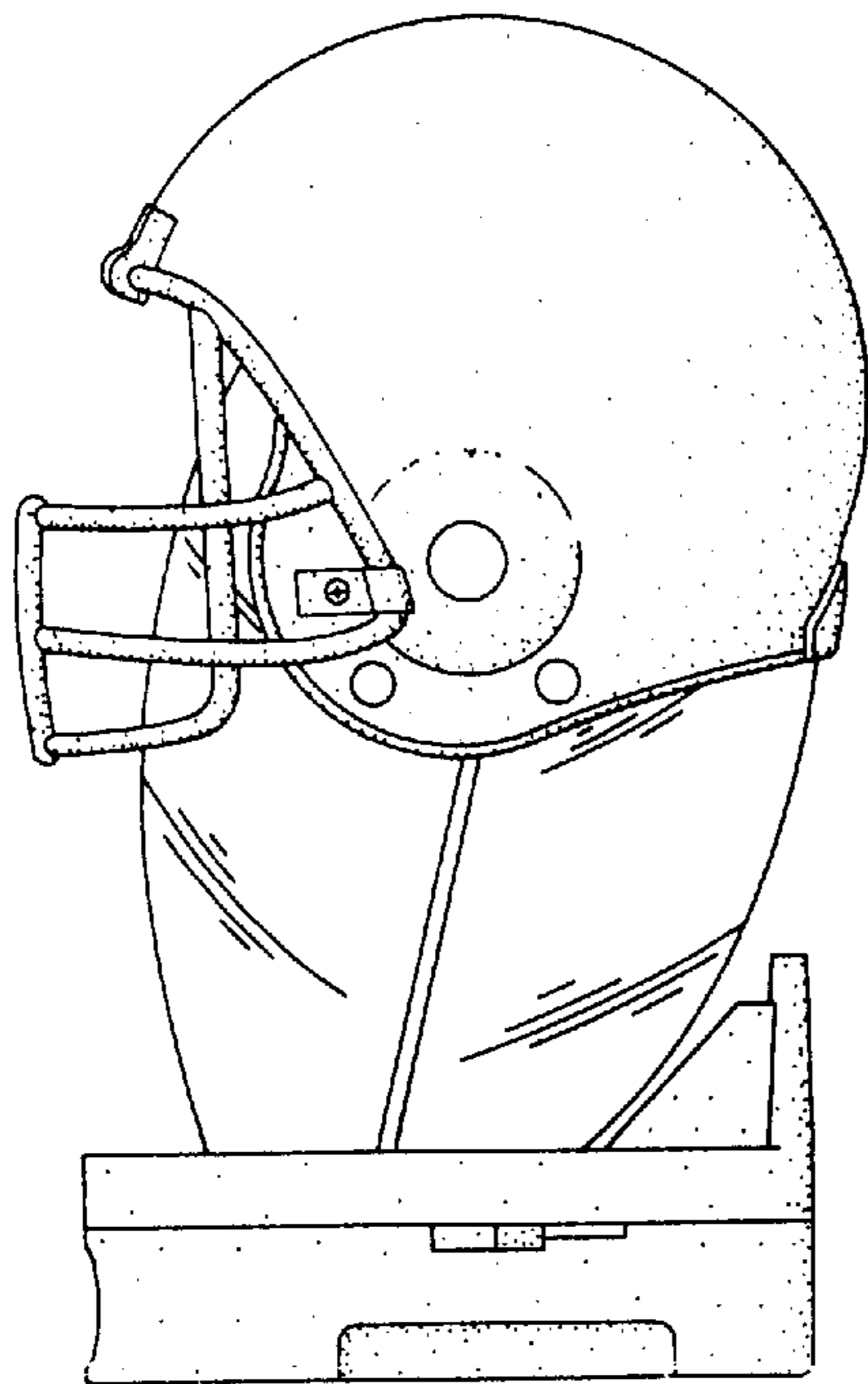
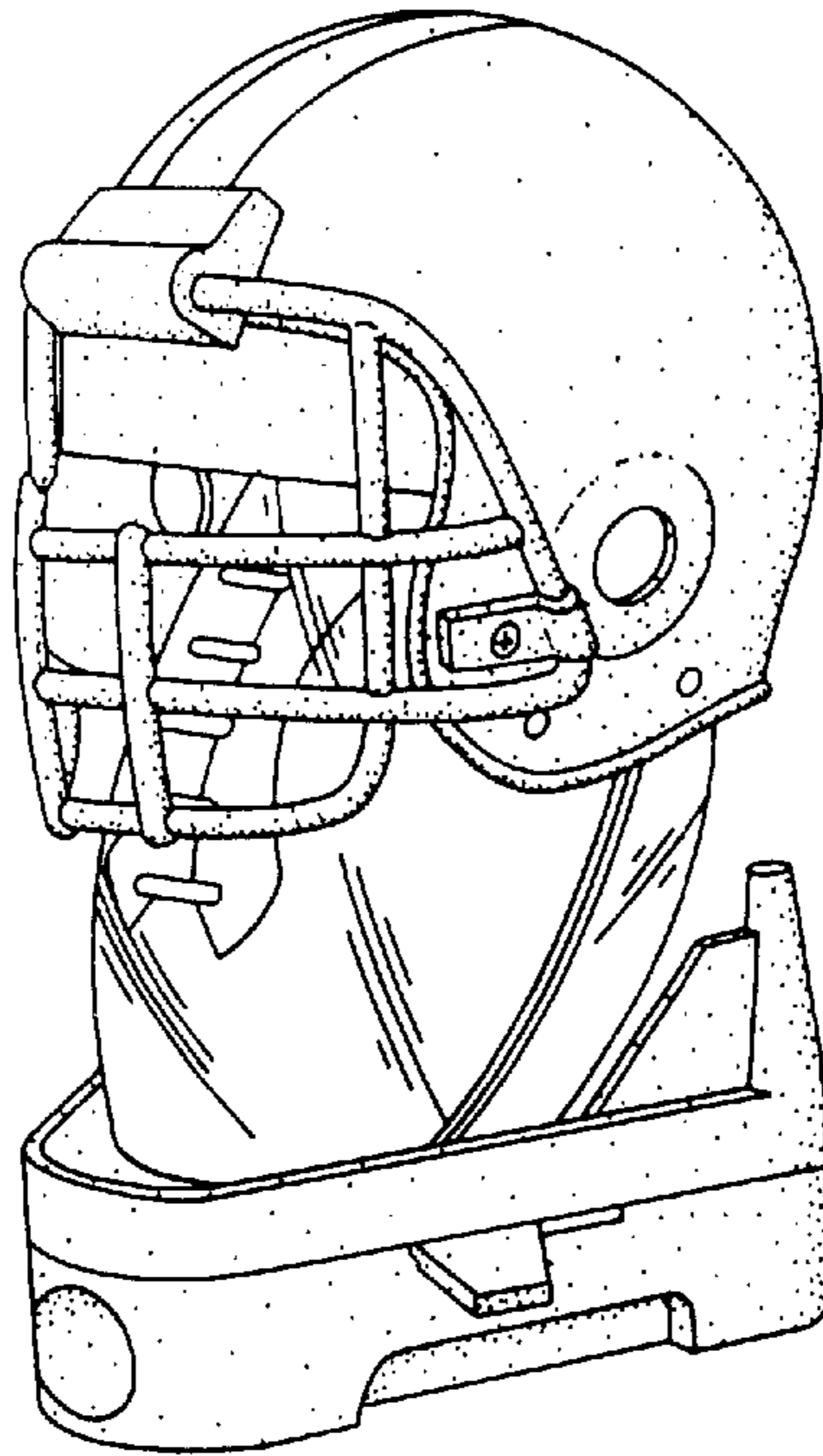

FIG 2

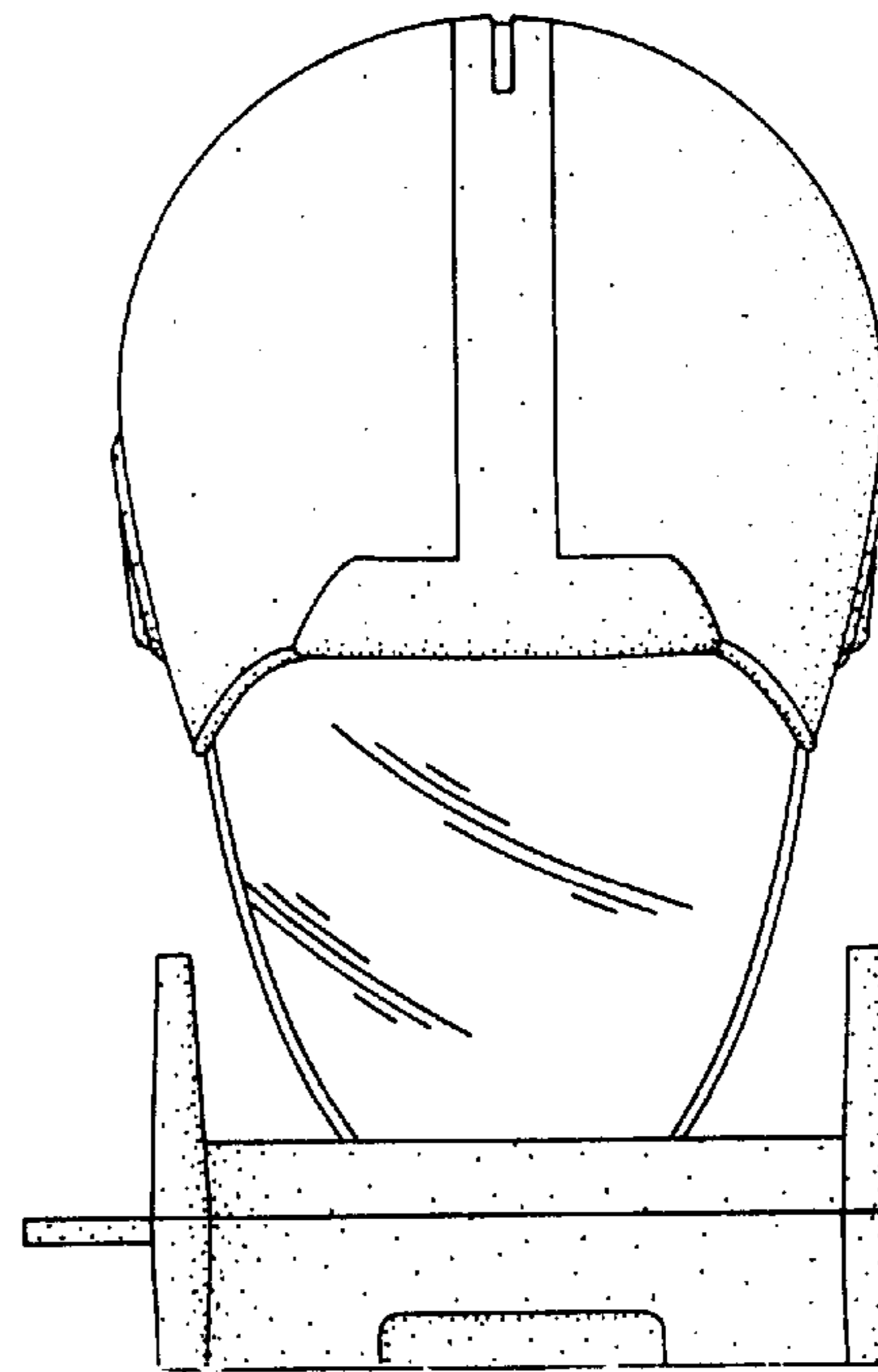

FIG 3

FIG 6

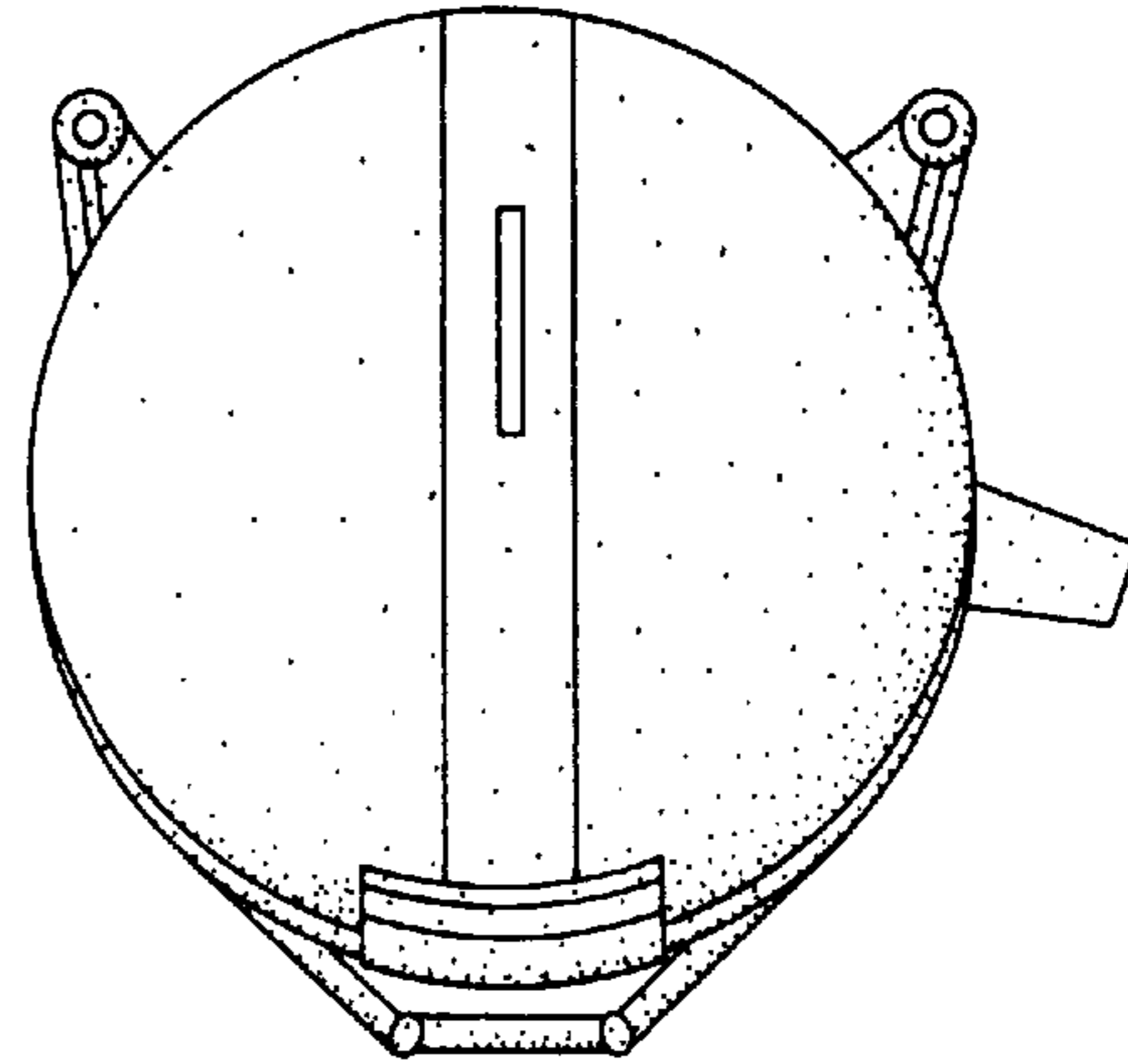

FIG 4

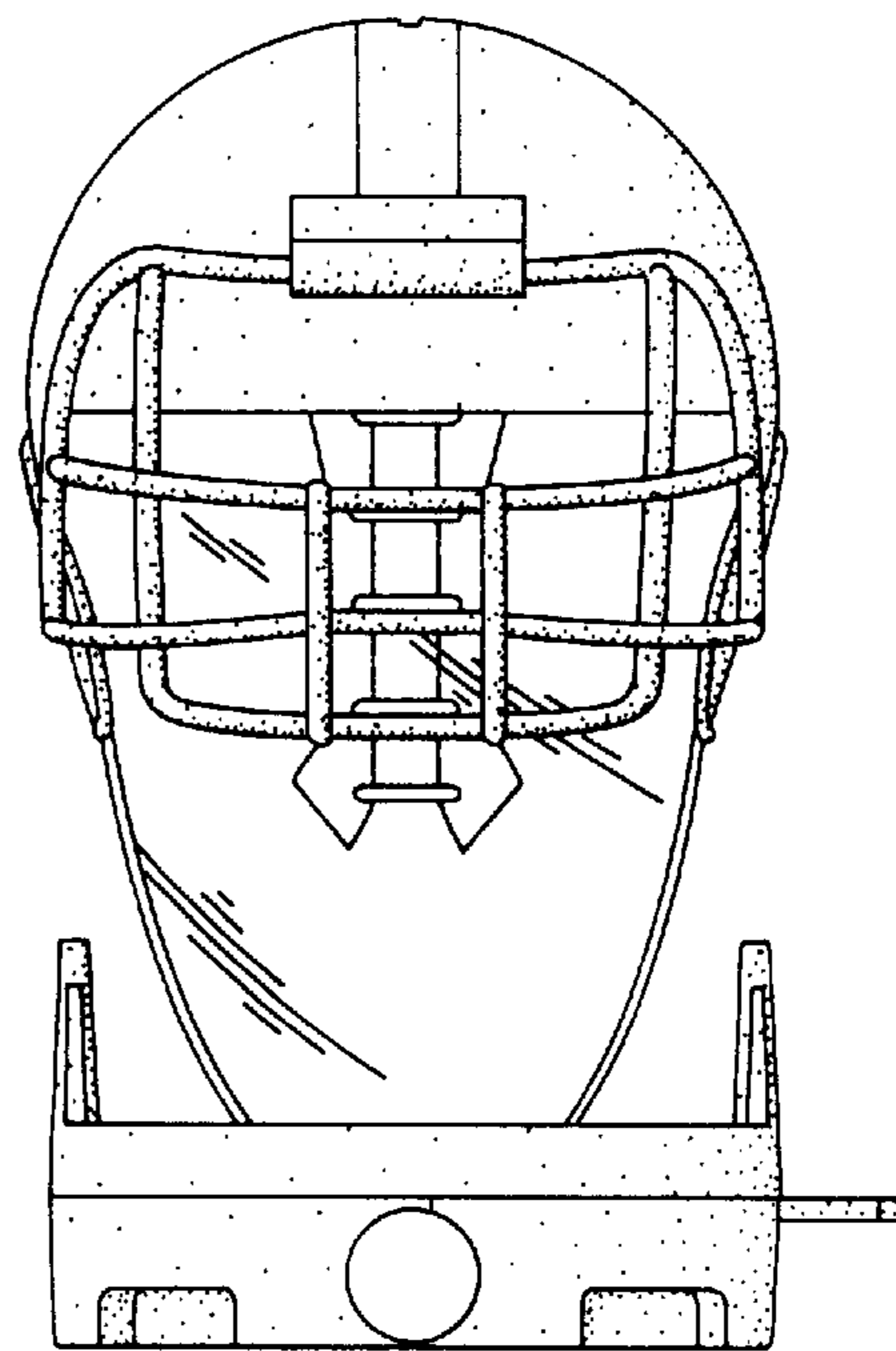
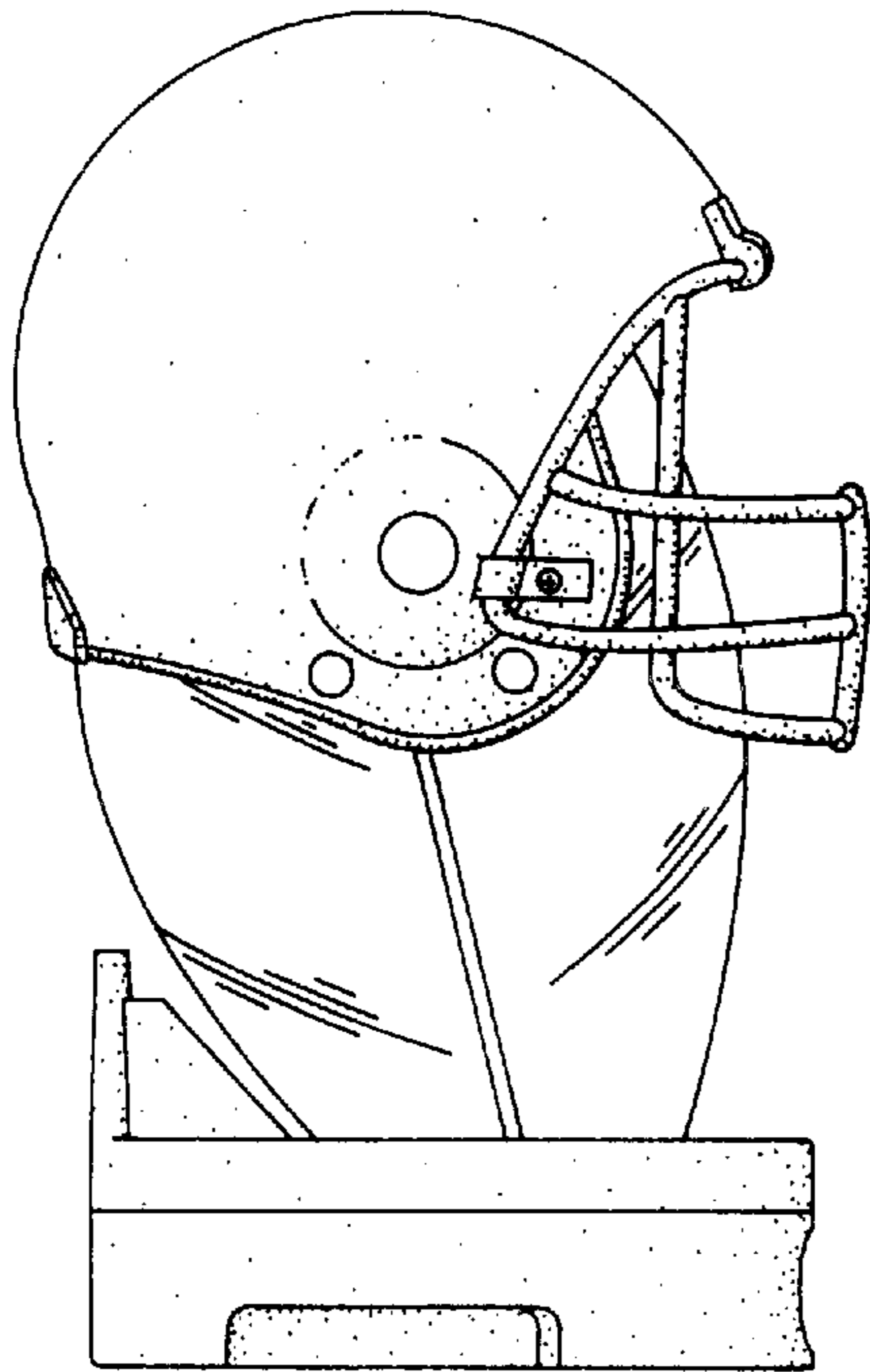

FIG 5

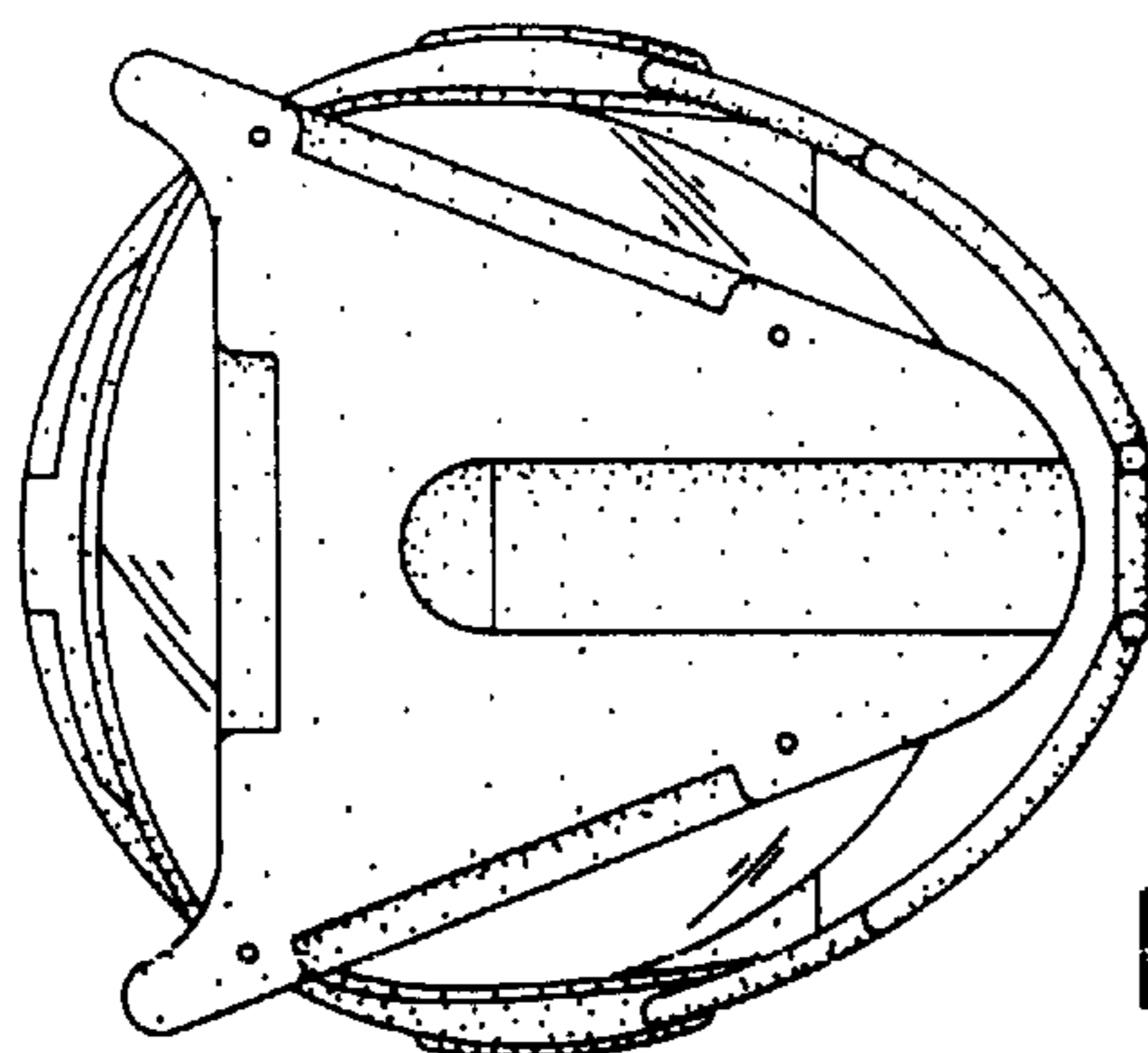

FIG 7