



US00D395081S

United States Patent [19]
Bowden

[11] **Patent Number:** **Des. 395,081**
[45] **Date of Patent:** ****Jun. 9, 1998**

[54] **STRAP ON CONDOM**

2225721 6/1990 United Kingdom 128/844
4013231 6/1994 WIPO 128/844

[76] **Inventor:** **Frederick John Bowden**, 18405 Gable,
Det., Mich. 48234

Primary Examiner—Louis S. Zarfes
Assistant Examiner—Eric Watterson

[**] **Term:** **14 Years**

[21] **Appl. No.:** **46,128**

[57] **CLAIM**

[22] **Filed:** **Mar. 21, 1996**

The ornamental design for a strap on condom, as shown and described.

[51] **LOC (6) Cl.** **24-99**

DESCRIPTION

[52] **U.S. Cl.** **D24/105**

[58] **Field of Search** D24/105; 628/844,
628/843, 842

FIG. 1 is a perspective view of a strap on condom, showing my new design;

FIG. 2 is a top view thereof;

FIG. 3 is a bottom view thereof;

FIG. 4 is a left side elevational view, the right side being a mirror image thereof;

FIG. 5 is a front elevational view thereof; and,

FIG. 6 is a rear elevational view thereof.

[56] **References Cited**

U.S. PATENT DOCUMENTS

4,354,494 10/1982 Hugin 128/844
5,121,755 6/1992 Hegedusch 128/844
5,158,556 10/1992 Starley 128/842 X

FOREIGN PATENT DOCUMENTS

3737908 5/1989 Germany 128/844

1 Claim, 1 Drawing Sheet

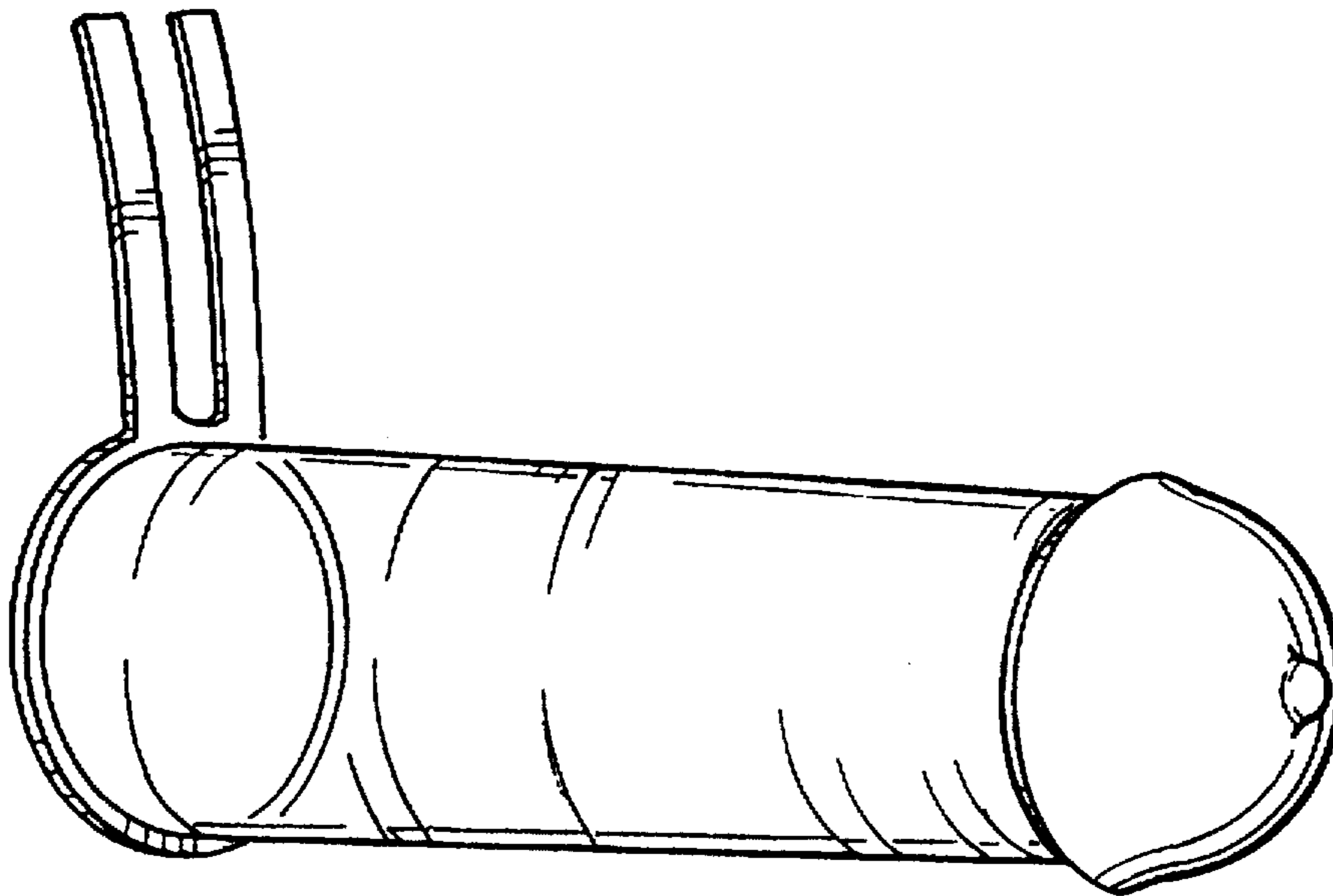

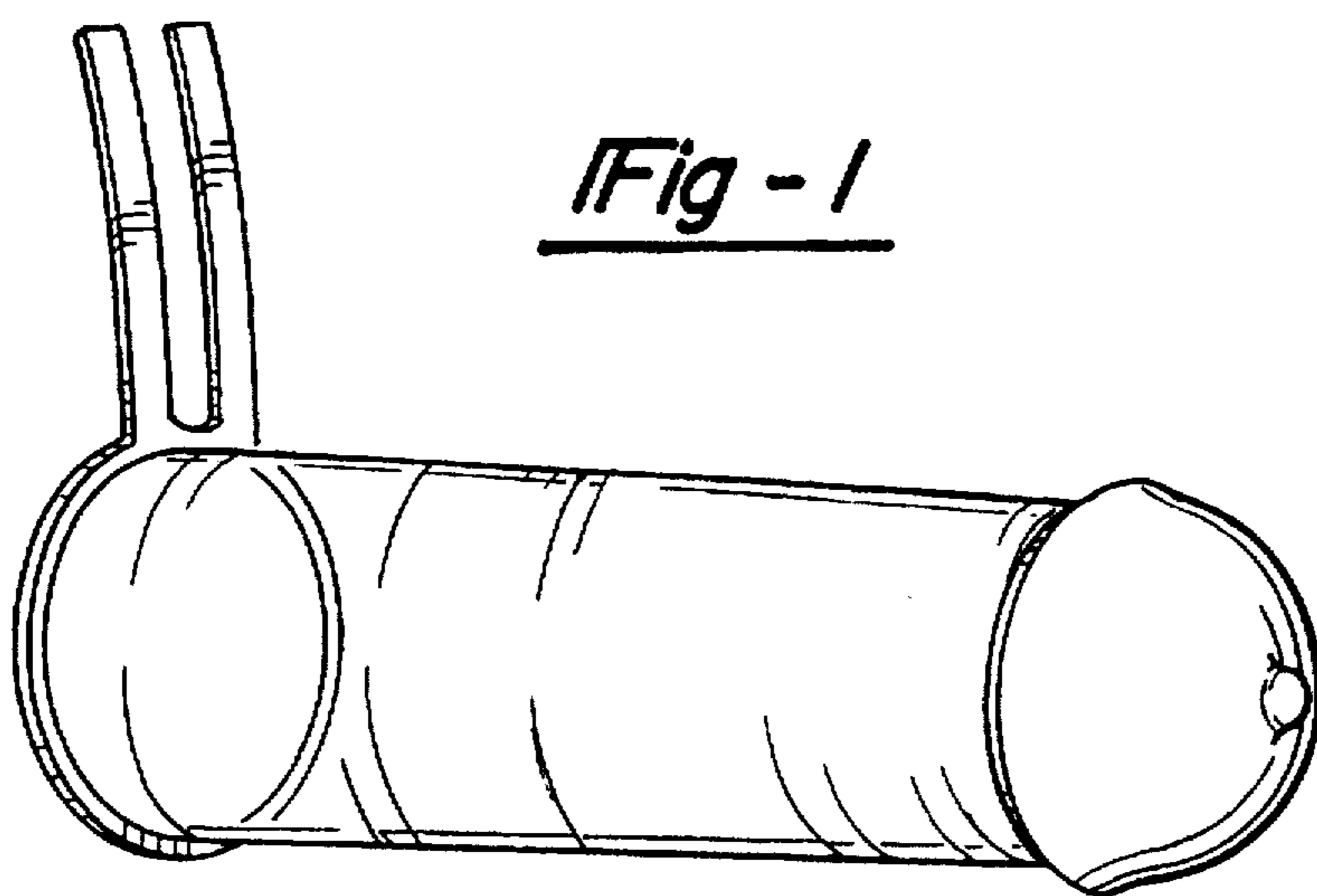

Fig - 1

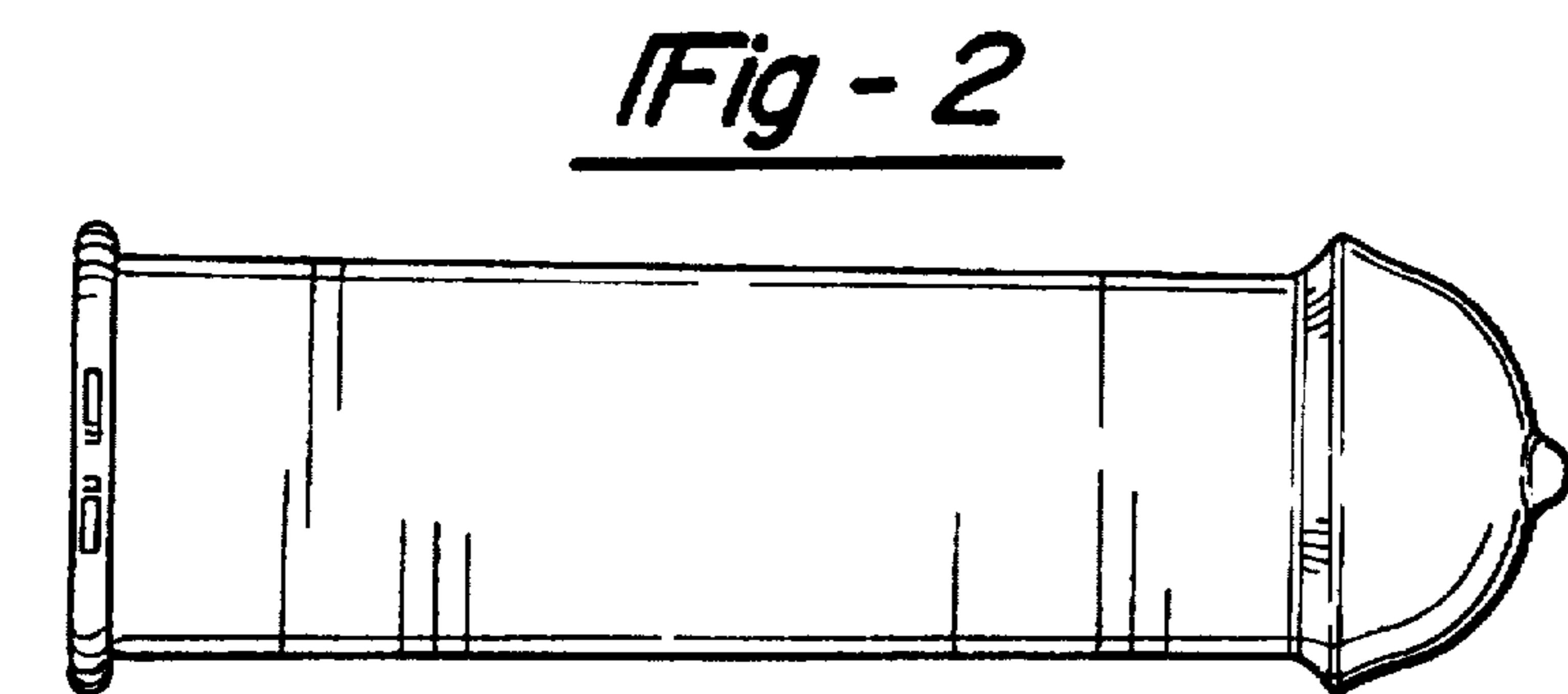

Fig - 2

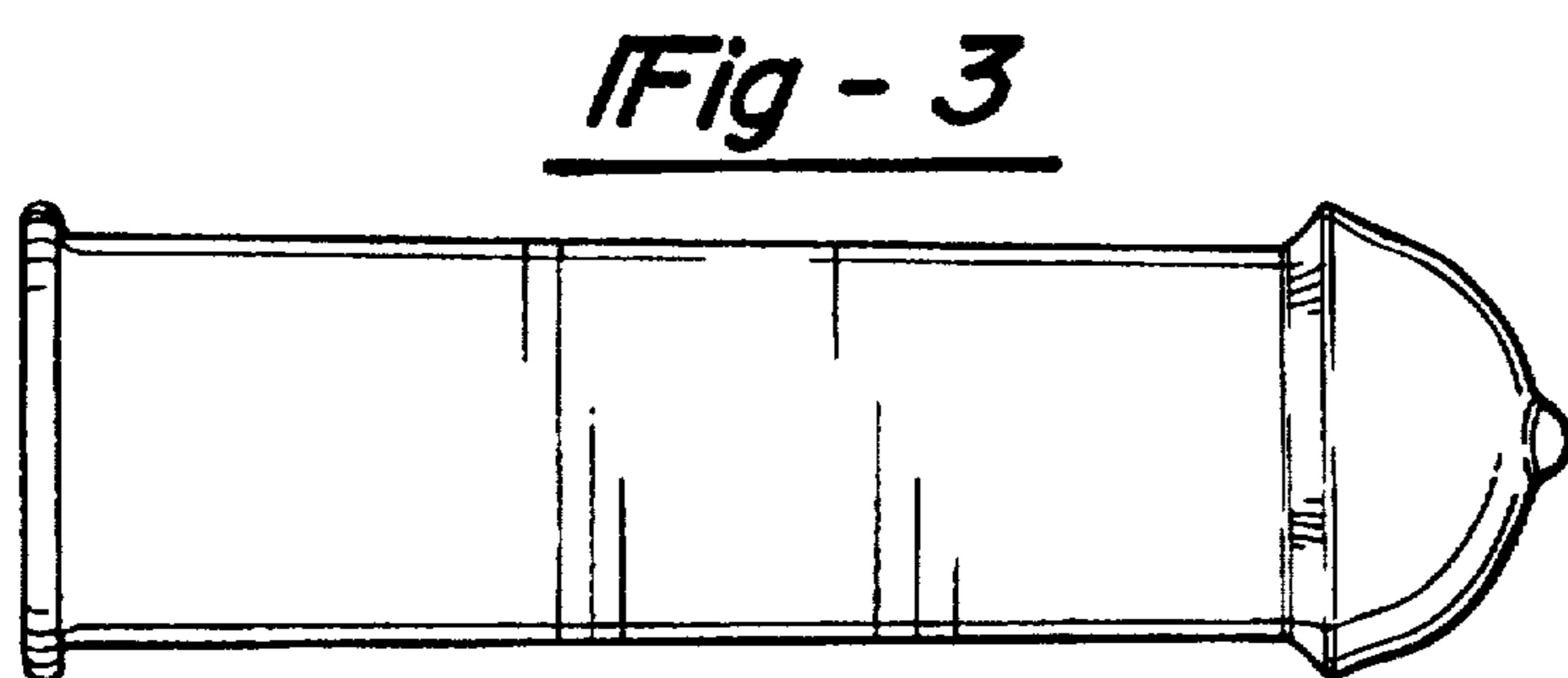

Fig - 3

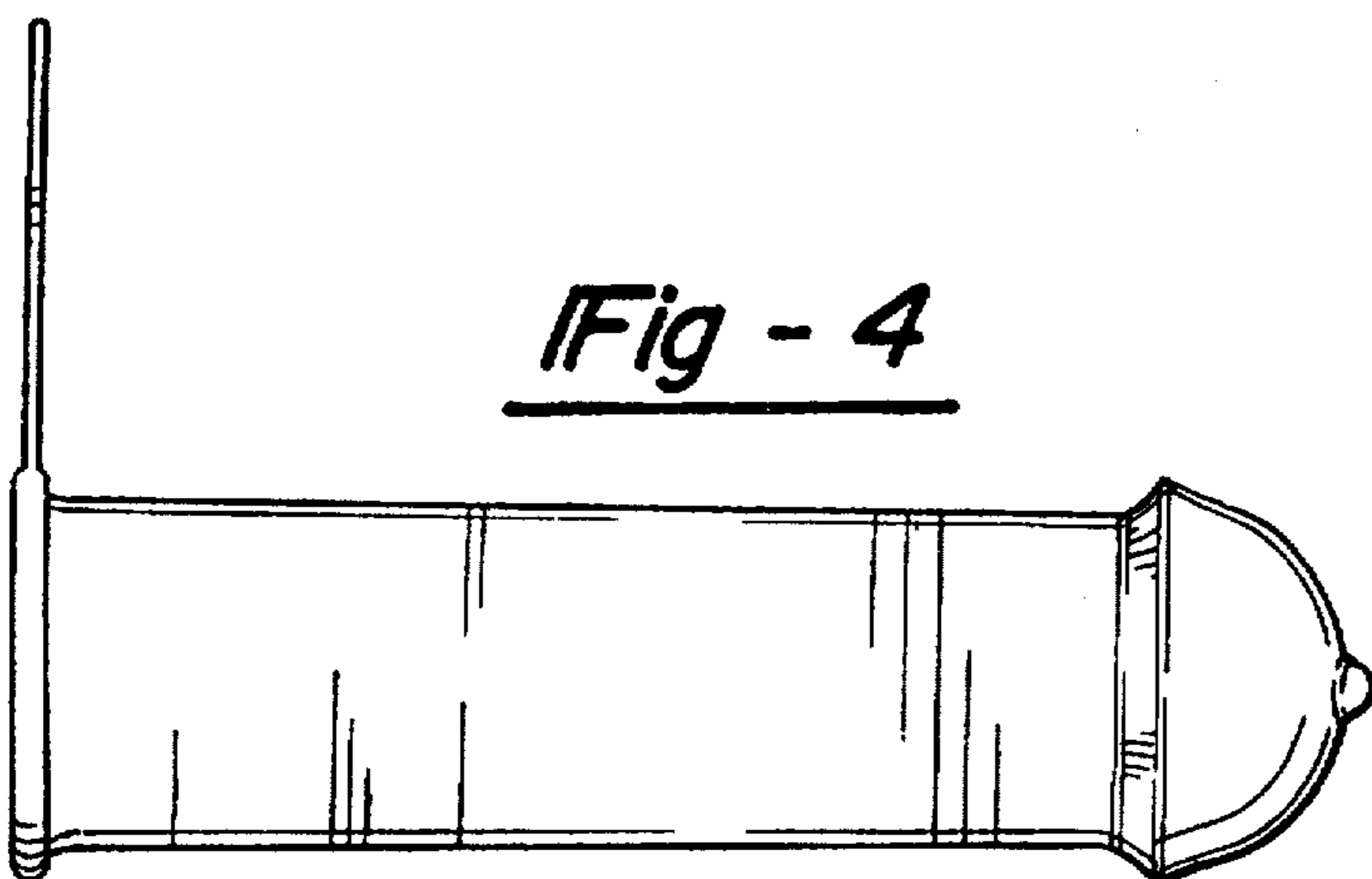

Fig - 4

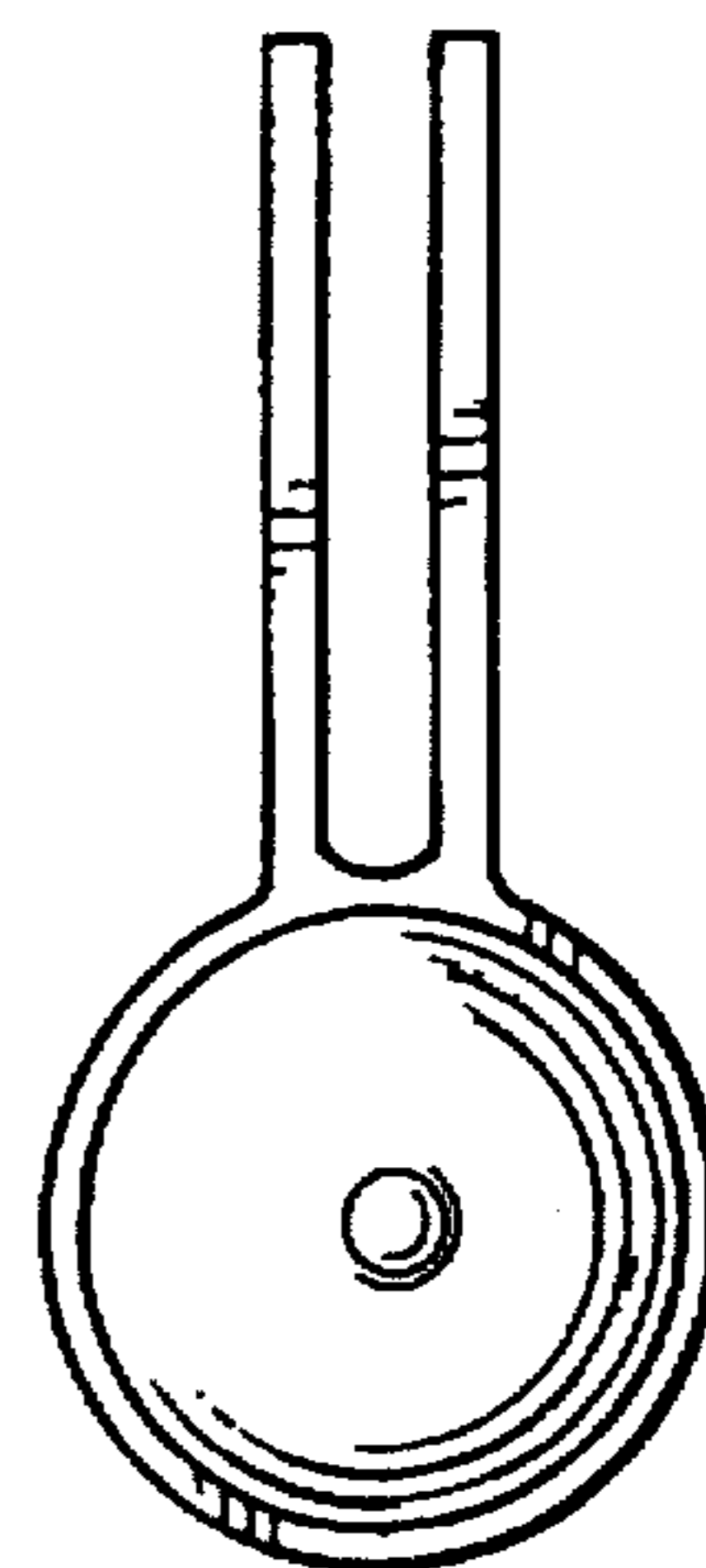

Fig - 5

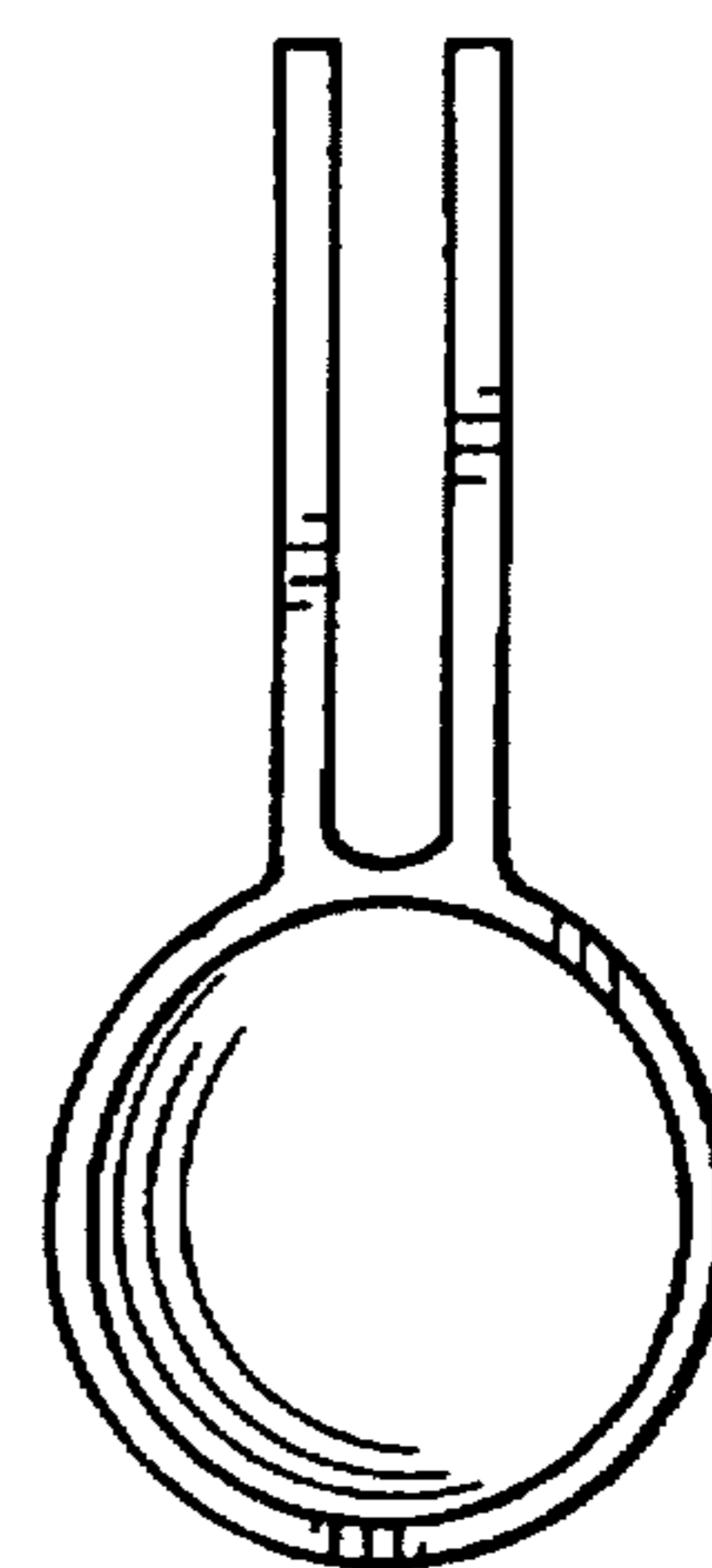

Fig - 6