



US00D395074S

# United States Patent [19]

Neibrook et al.

[11] Patent Number: **Des. 395,074**

[45] Date of Patent: **\*\*Jun. 9, 1998**

[54] **SHOWER HEAD**

D. 290,497 6/1987 Huen ..... D23/229  
D. 313,833 1/1991 Presman ..... D23/213

[75] Inventors: **Dennis W. Neibrook**, Harrisonville;  
**Bryce D. Schellhorn**, Clinton, both of  
Mo.; **Velissa M. Van Scoyoc**,  
Newtown, Pa.

### OTHER PUBLICATIONS

Craftech Collection, item #02-0003-1 shower head, 1995.

[73] Assignee: **The Rival Company**, Kansas City, Mo.

*Primary Examiner*—Alan P. Douglas  
*Assistant Examiner*—Robin V. Taylor  
*Attorney, Agent, or Firm*—Brinks Hofer Gilson & Lione

[\*\*] Term: **14 Years**

### [57] CLAIM

[21] Appl. No.: **49,068**

The ornamental design for a shower head, as shown and described.

[22] Filed: **Jan. 16, 1996**

### DESCRIPTION

[51] LOC (6) Cl. .... **23-01**

[52] U.S. Cl. .... **D23/229**

[58] Field of Search ..... D23/213, 223-226,  
D23/229, 230; 239/525, 526, 548, 550,  
556, 559

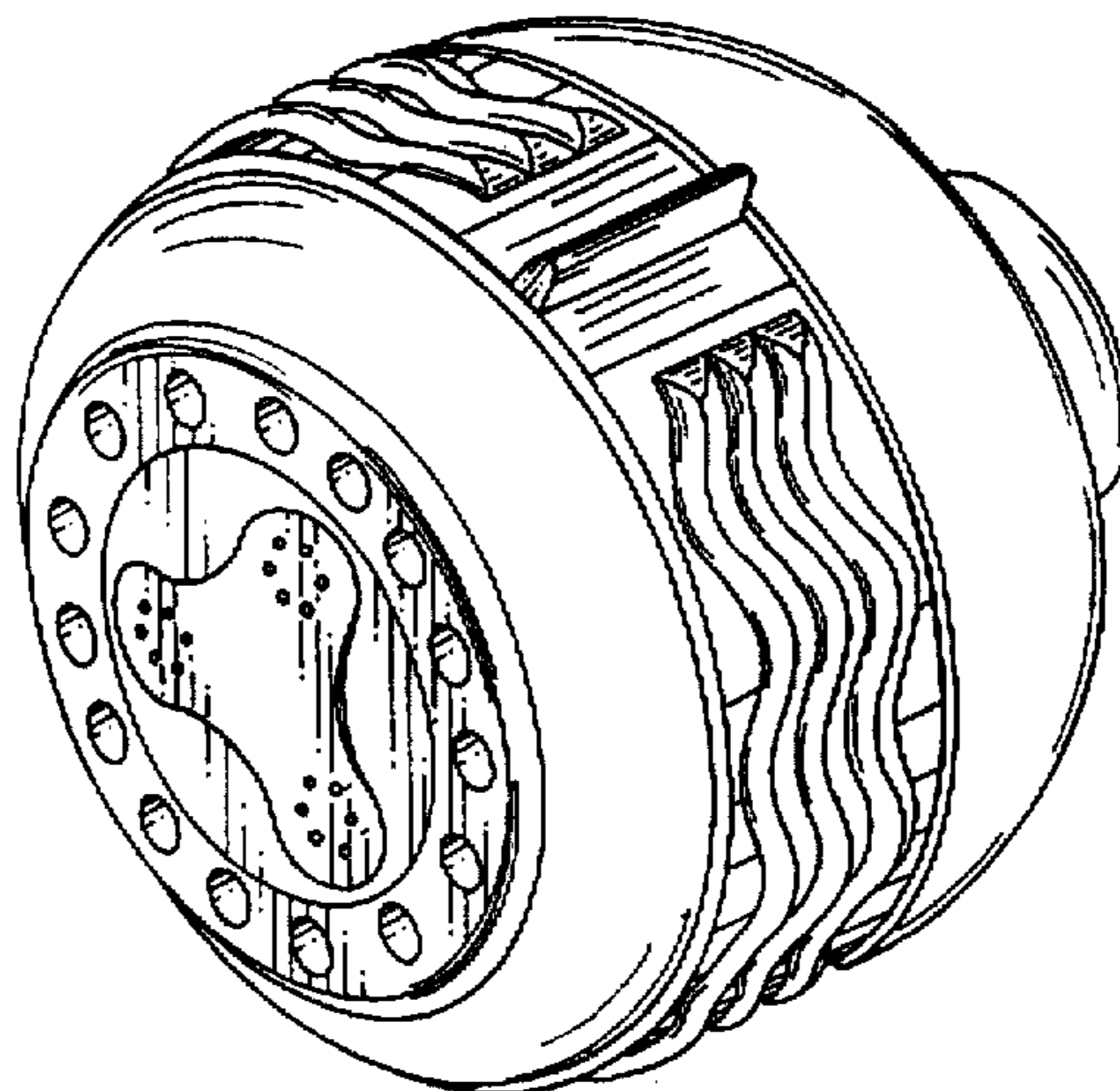
FIG. 1 is a perspective view of a shower head showing our new design;  
FIG. 2 is a right side view thereof;  
FIG. 3 is a front view thereof;  
FIG. 4 is a left side view thereof;  
FIG. 5 is a rear view thereof;  
FIG. 6 is a top view thereof; and,  
FIG. 7 is a bottom view thereof.

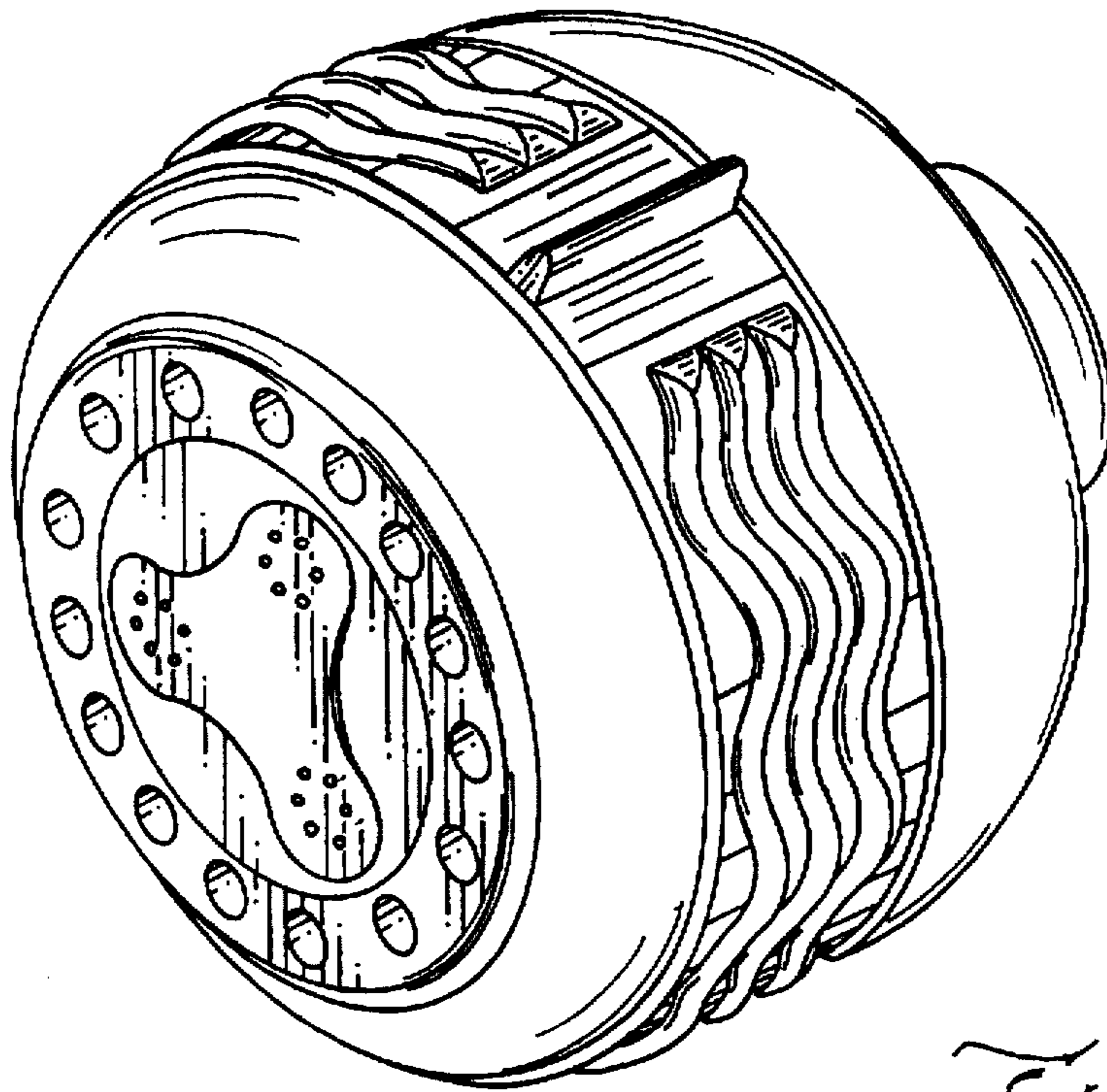
### [56] References Cited

#### U.S. PATENT DOCUMENTS

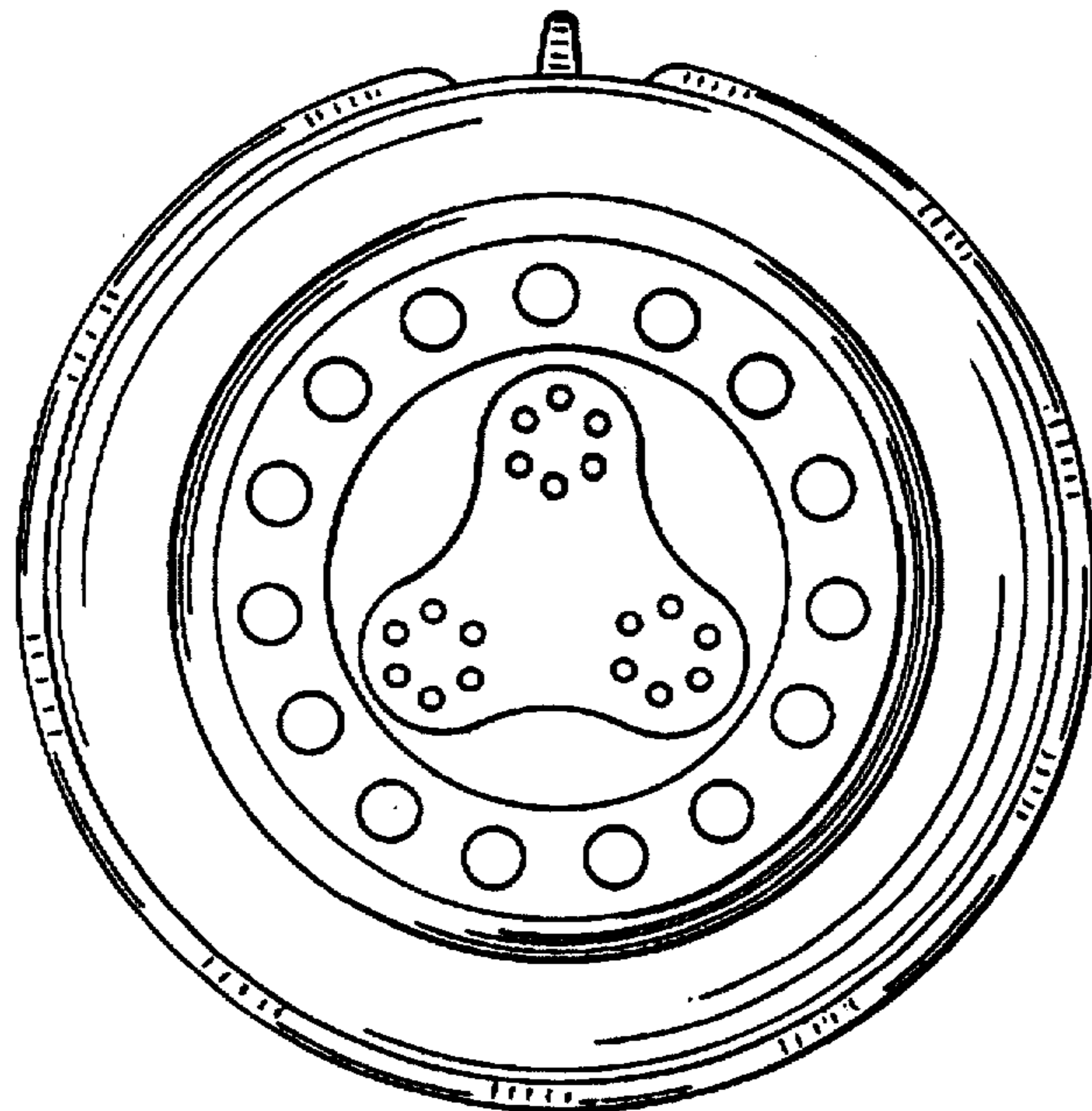
D. 115,795 7/1939 Reinecke ..... D23/230  
D. 145,538 9/1946 Richards ..... D23/213  
D. 267,581 1/1983 Mackay et al. .... D23/229

**1 Claim, 3 Drawing Sheets**



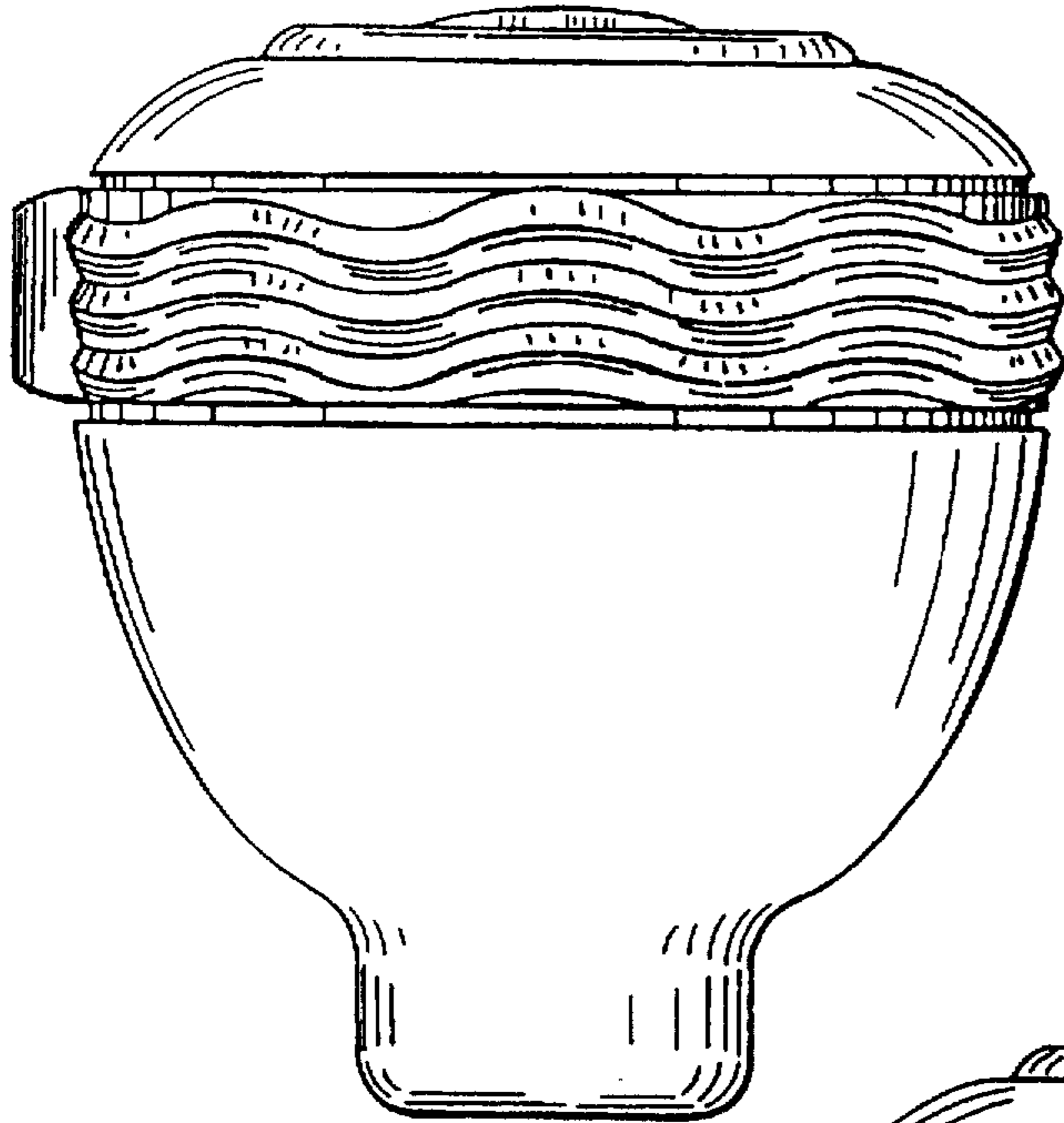


*Fig. 1*

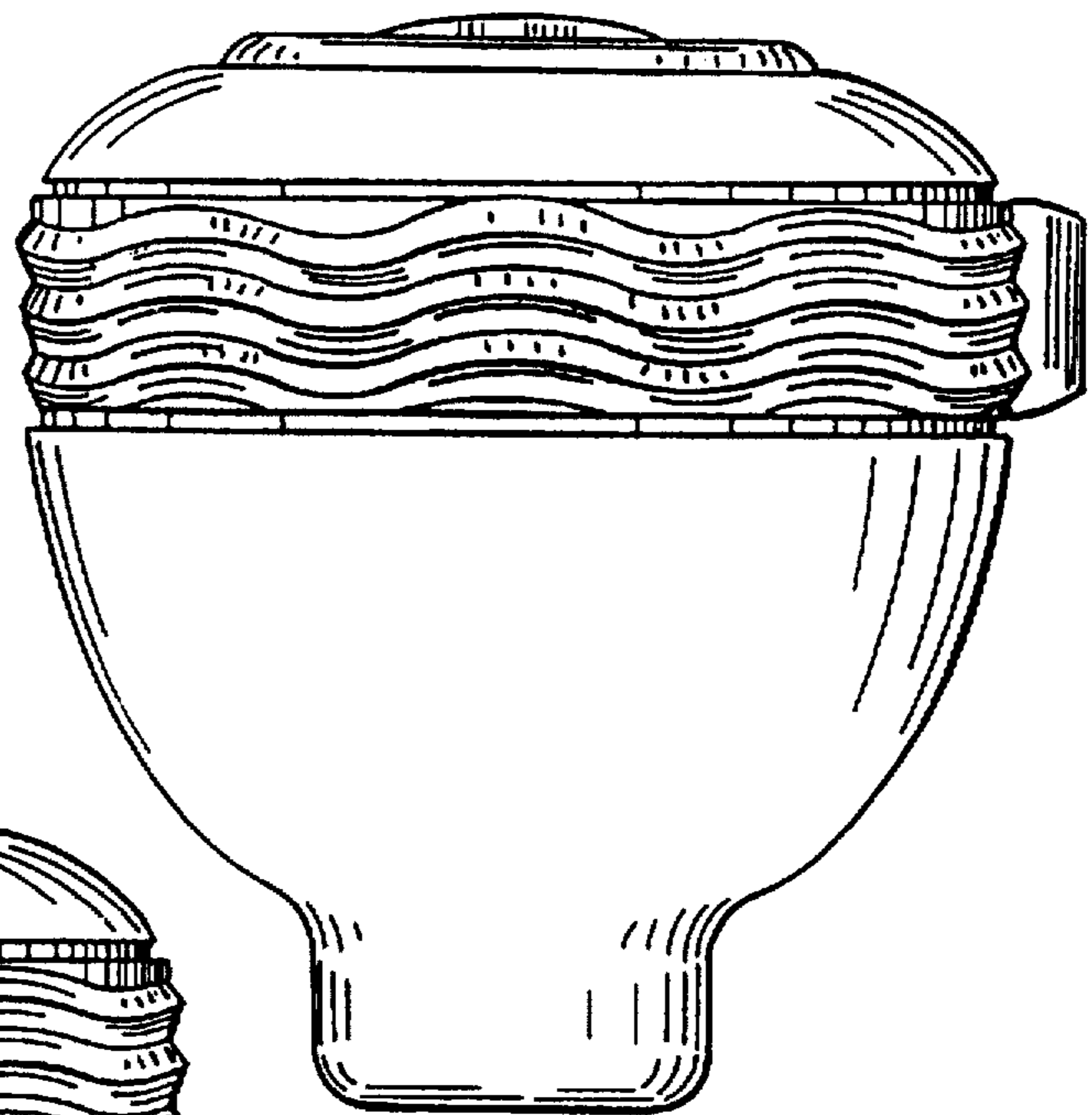


*Fig. 3*

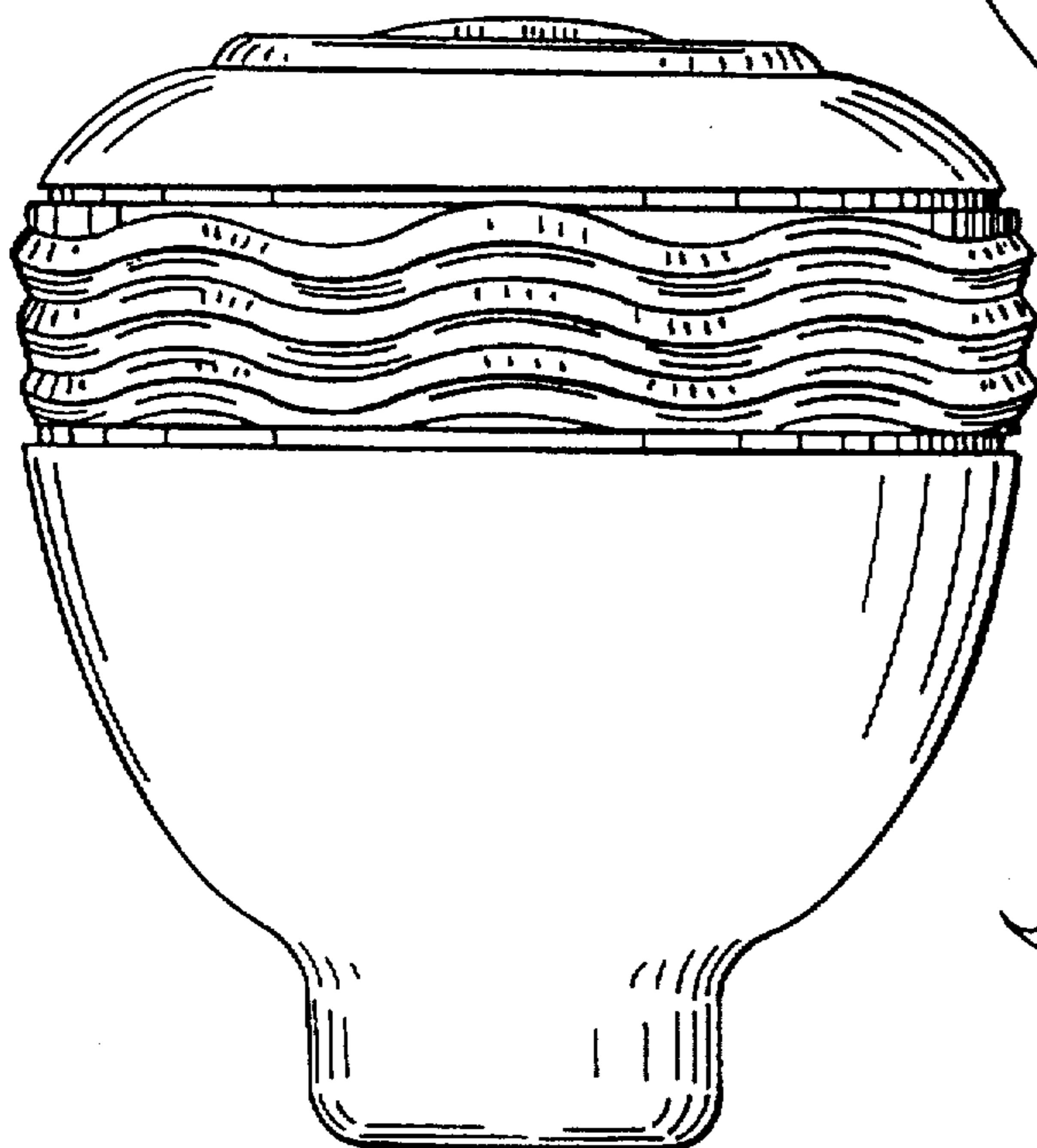
*Fig. 2*

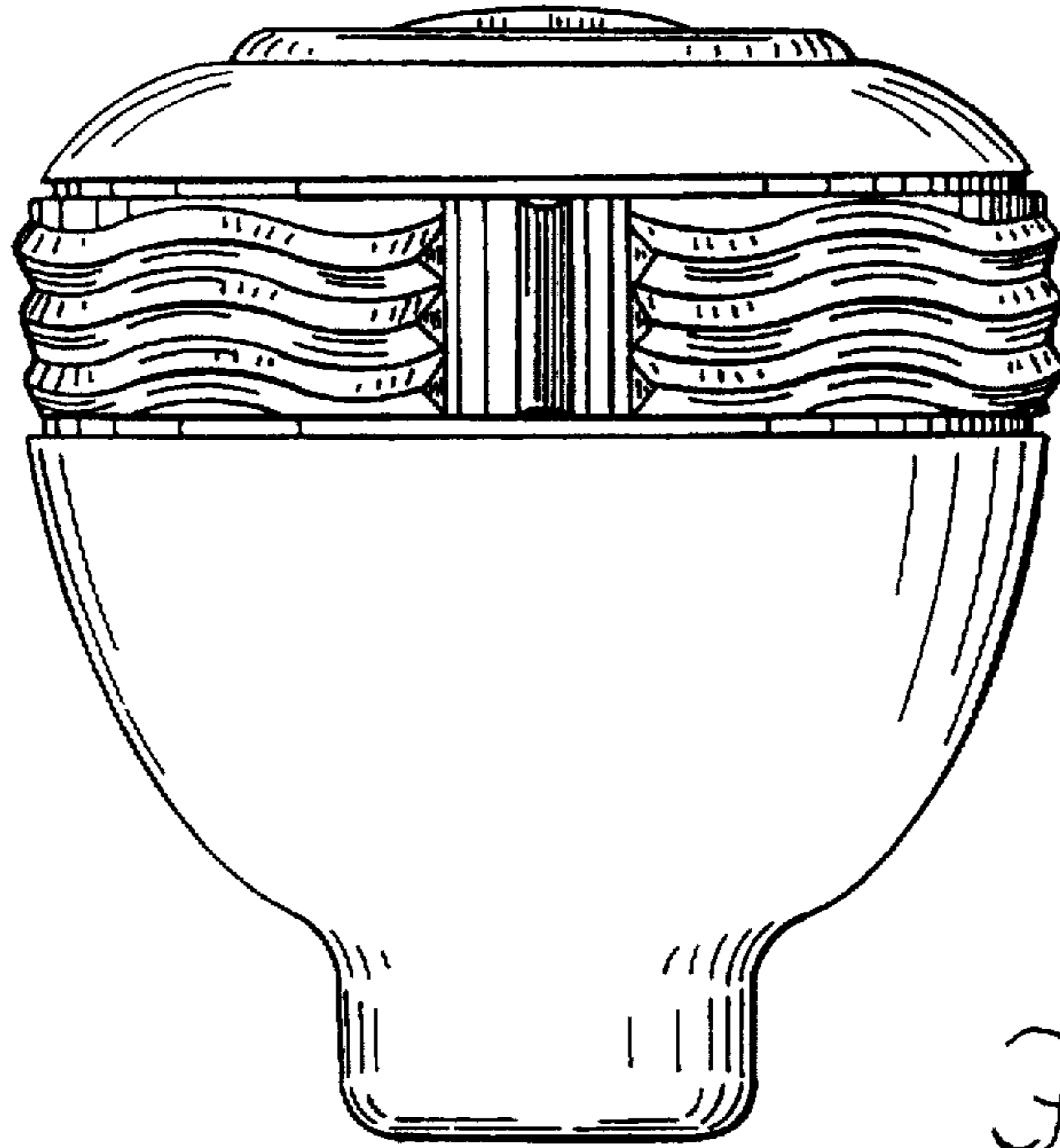


*Fig. 4*

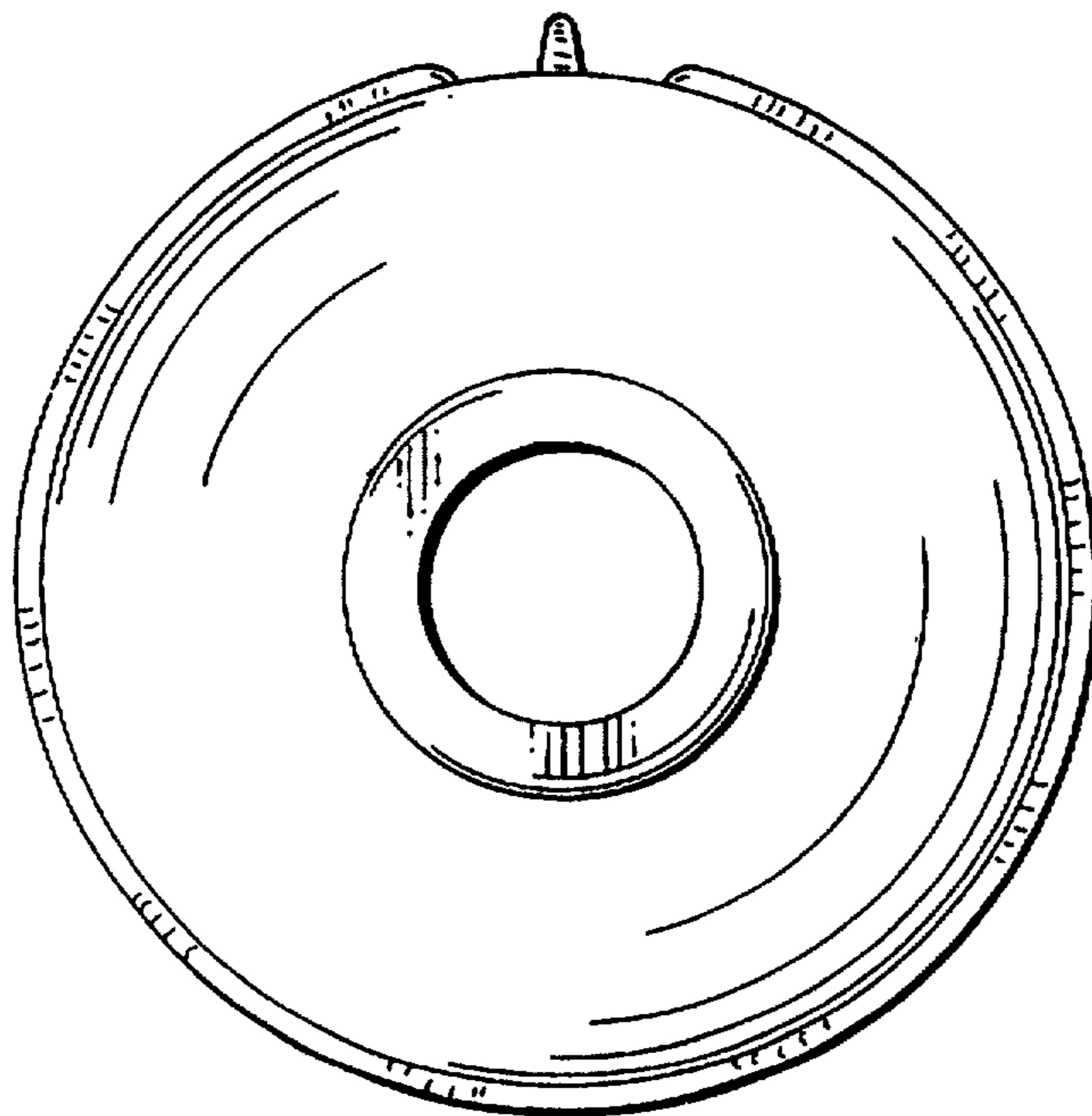


*Fig. 7*





*Fig. 6*



*Fig. 5*