



US00D395051S

**United States Patent** [19]  
**Bonzer**

[11] **Patent Number:** **Des. 395,051**

[45] **Date of Patent:** **\*\*Jun. 9, 1998**

[54] **INFLATION STATION**

[76] **Inventor:** **Robert L. Bonzer**, 905 W. Amity Rd.,  
Boise, Id. 83705

[\*\*] **Term:** **14 Years**

[21] **Appl. No.:** **74,287**

[22] **Filed:** **Jul. 23, 1997**

[51] **LOC (6) Cl.** ..... **15-02**

[52] **U.S. Cl.** ..... **D15/9**

[58] **Field of Search** ..... D15/7-9; 417/234-235,  
417/360, 415; D26/38; 248/645

[56] **References Cited**

**U.S. PATENT DOCUMENTS**

D. 293,447	12/1994	Hefling	.....	D15/9
D. 339,356	9/1993	Tsai	.....	D15/8
D. 340,458	10/1993	Wang	.....	D15/7
D. 375,962	11/1996	Wong	.....	D15/9

*Primary Examiner*—Ralf Seifert  
*Attorney, Agent, or Firm*—Frank J. Dykas

[57] **CLAIM**

The ornamental design for an inflation station, as shown and described.

**DESCRIPTION**

FIG. 1 is a perspective view of an inflation station showing my new design;

FIG. 2 is a perspective view of the inflation station showing internal parts;

FIG. 3 is a top view of the inflation station;

FIG. 4 is a bottom view of the inflation station;

FIG. 5 is a right side view of the inflation station;

FIG. 6 is a left side view of the inflation station;

FIG. 7 is a front view of the inflation station; and,

FIG. 8 is a back view of the inflation station.

**1 Claim, 5 Drawing Sheets**

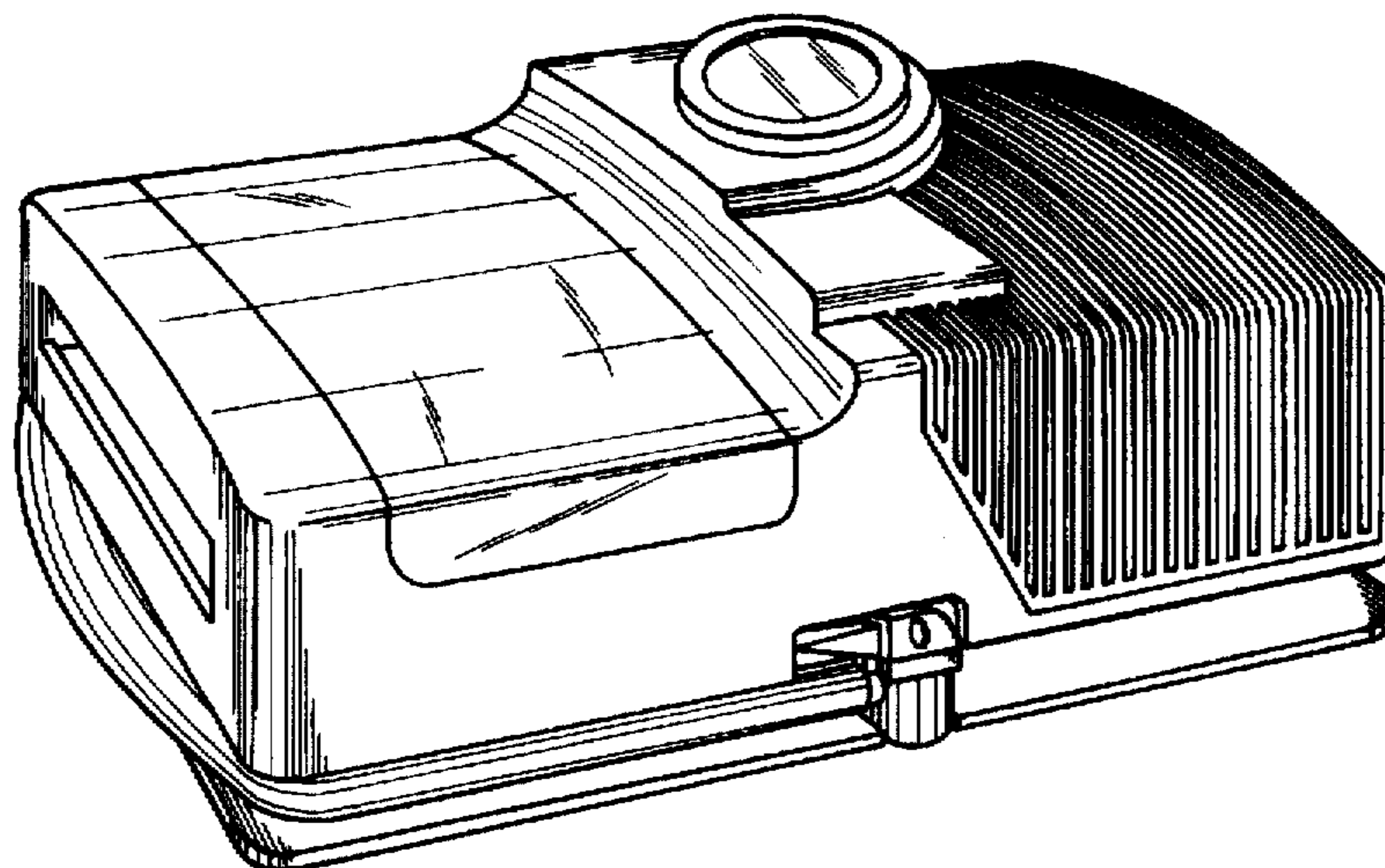

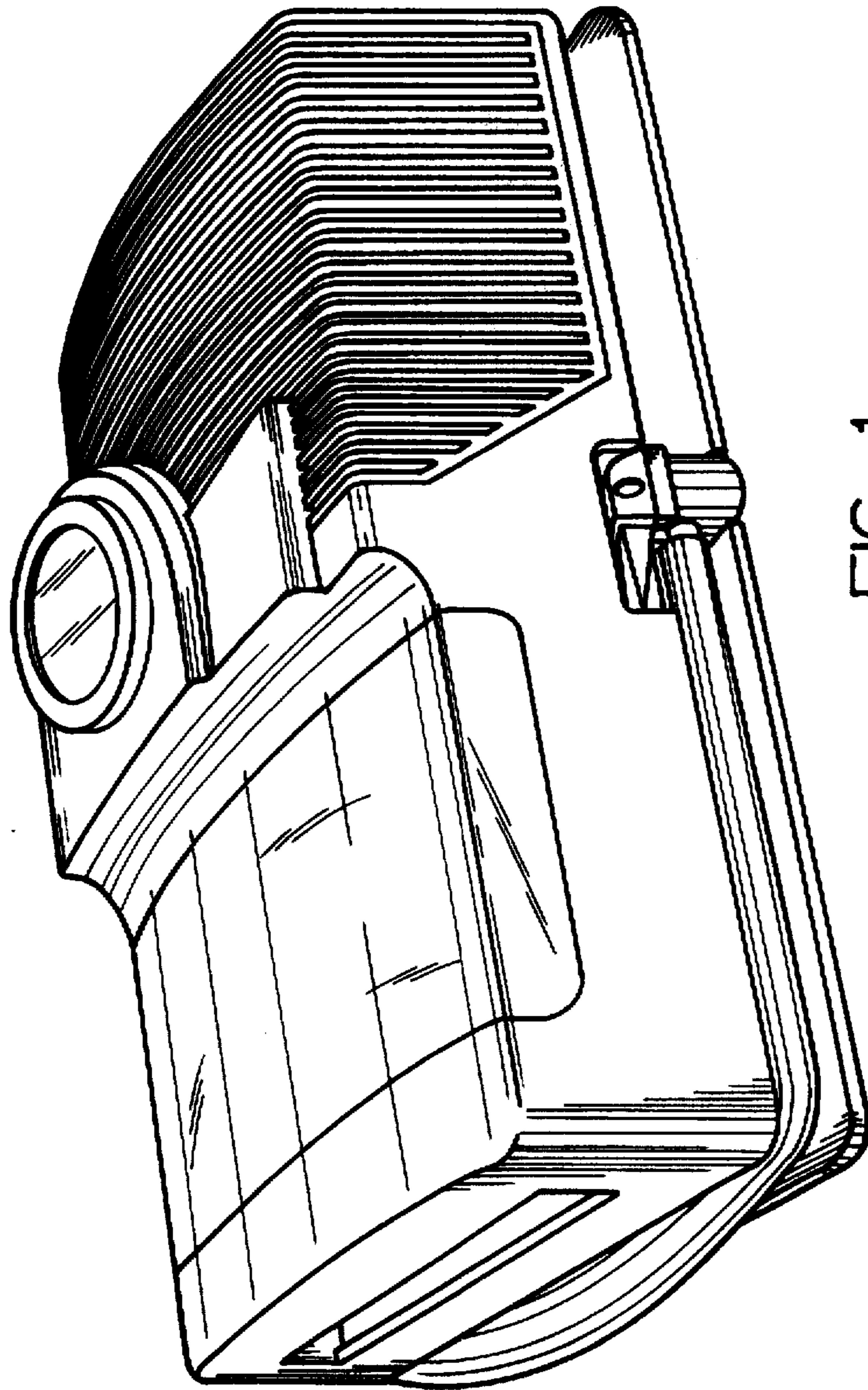

FIG. 1

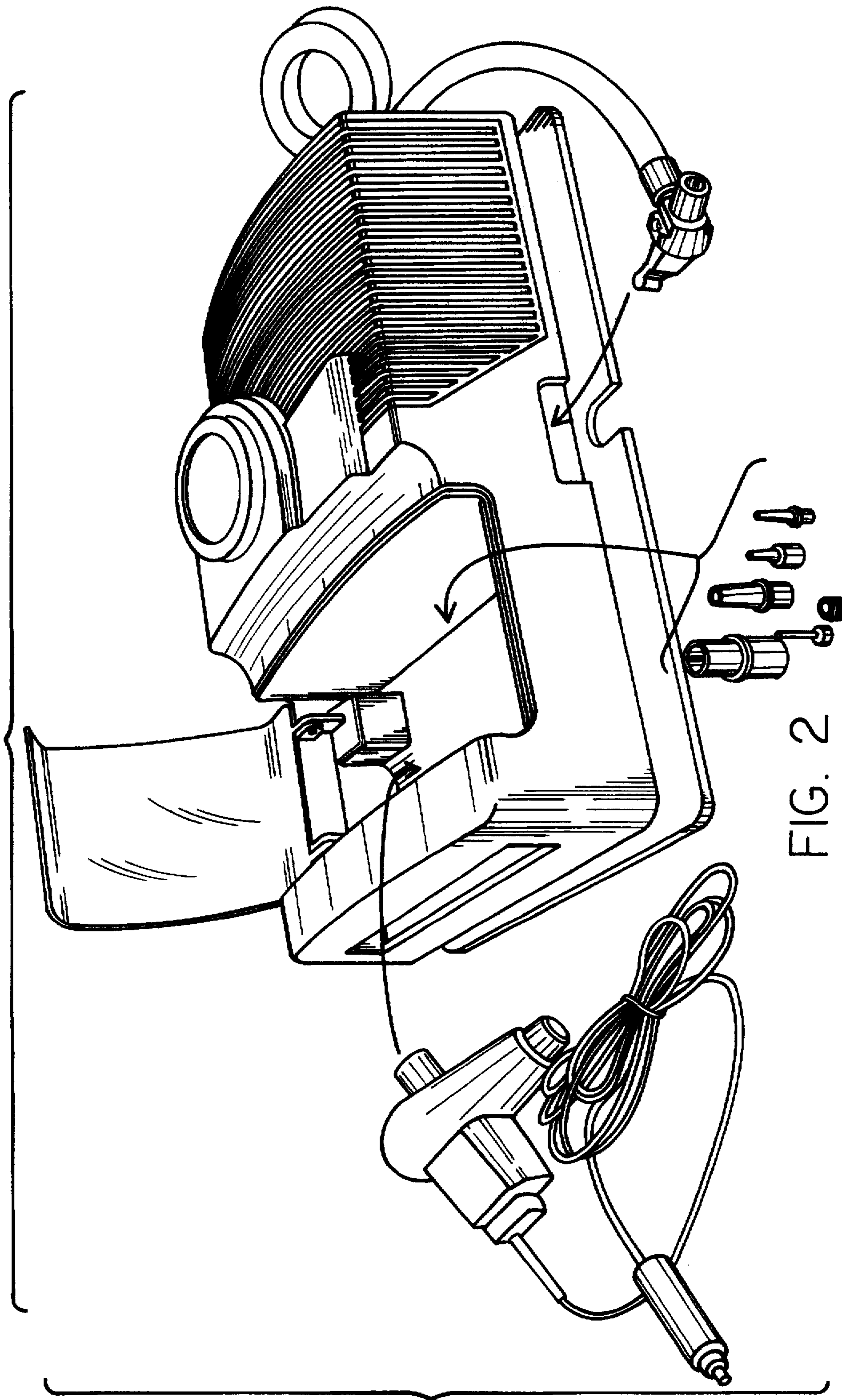

FIG. 2

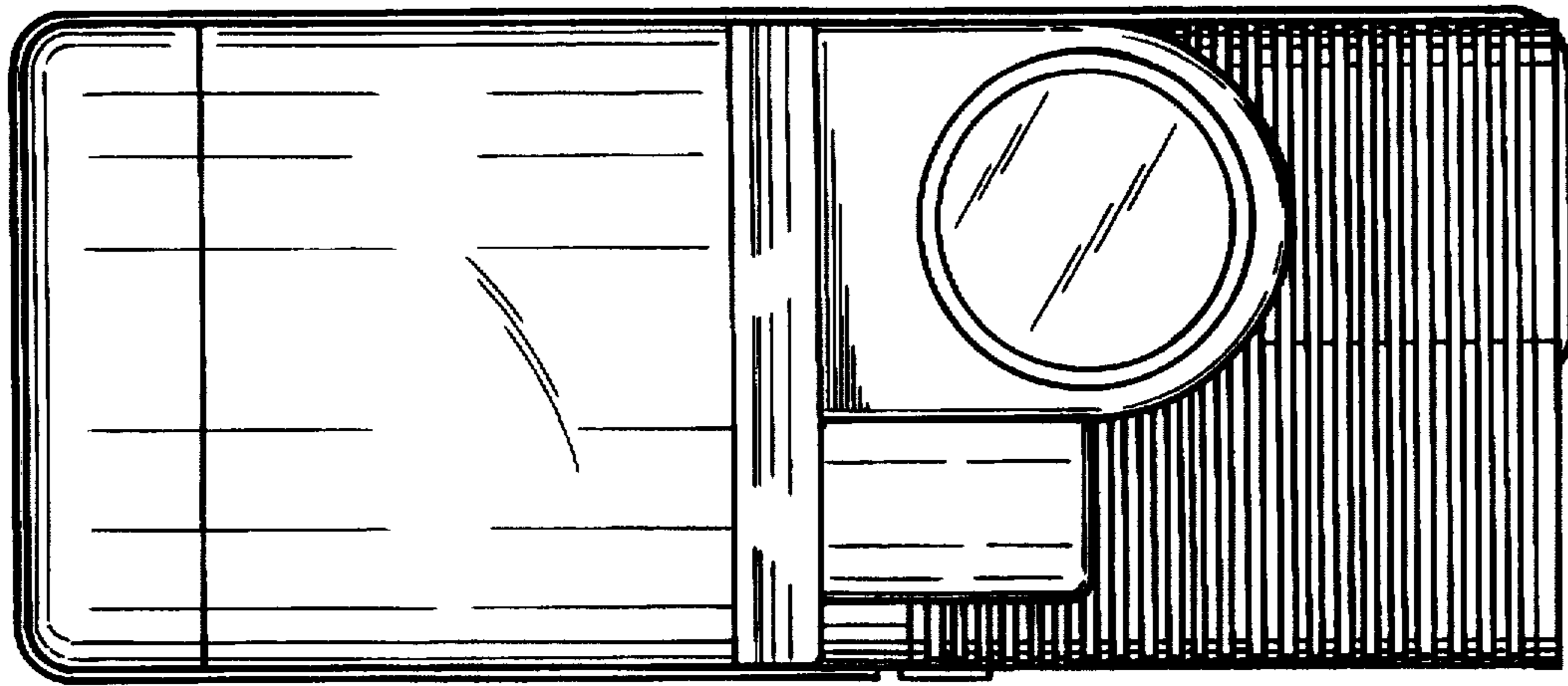

FIG. 3

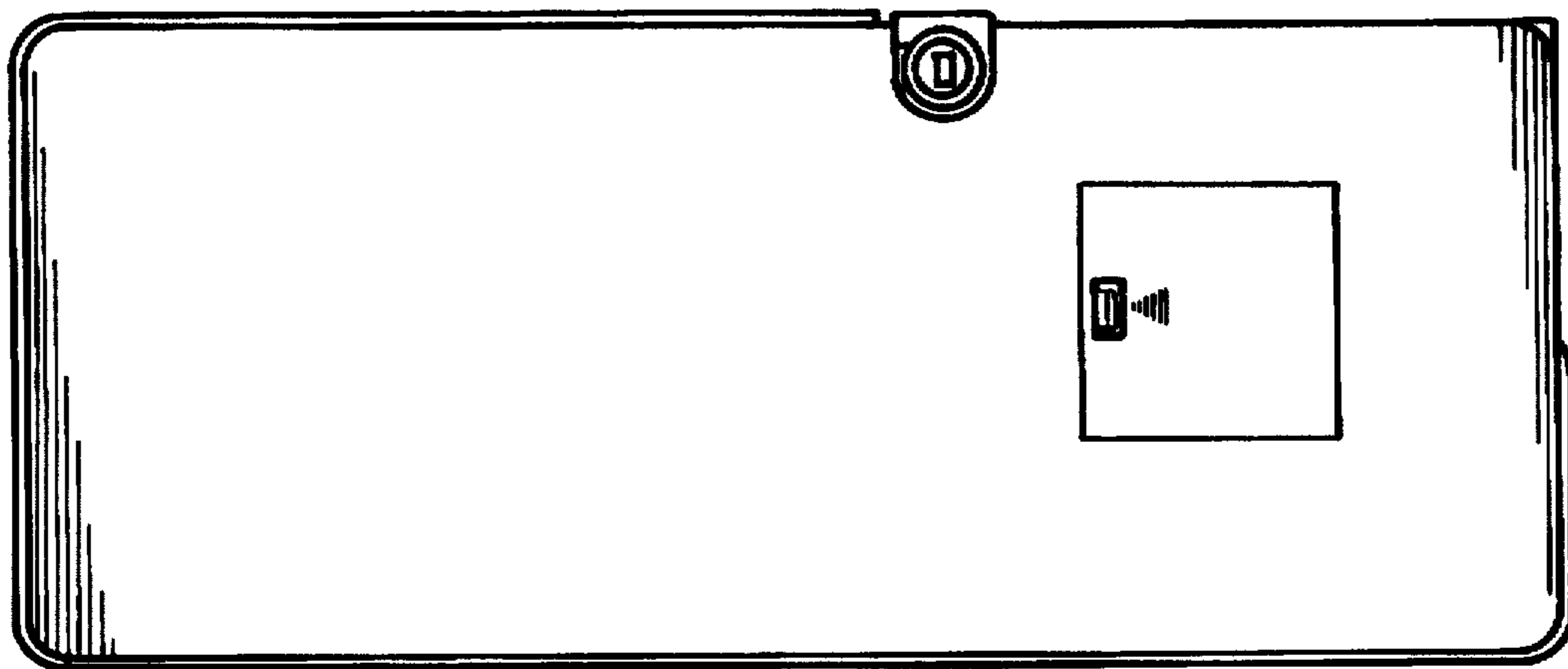

FIG. 4



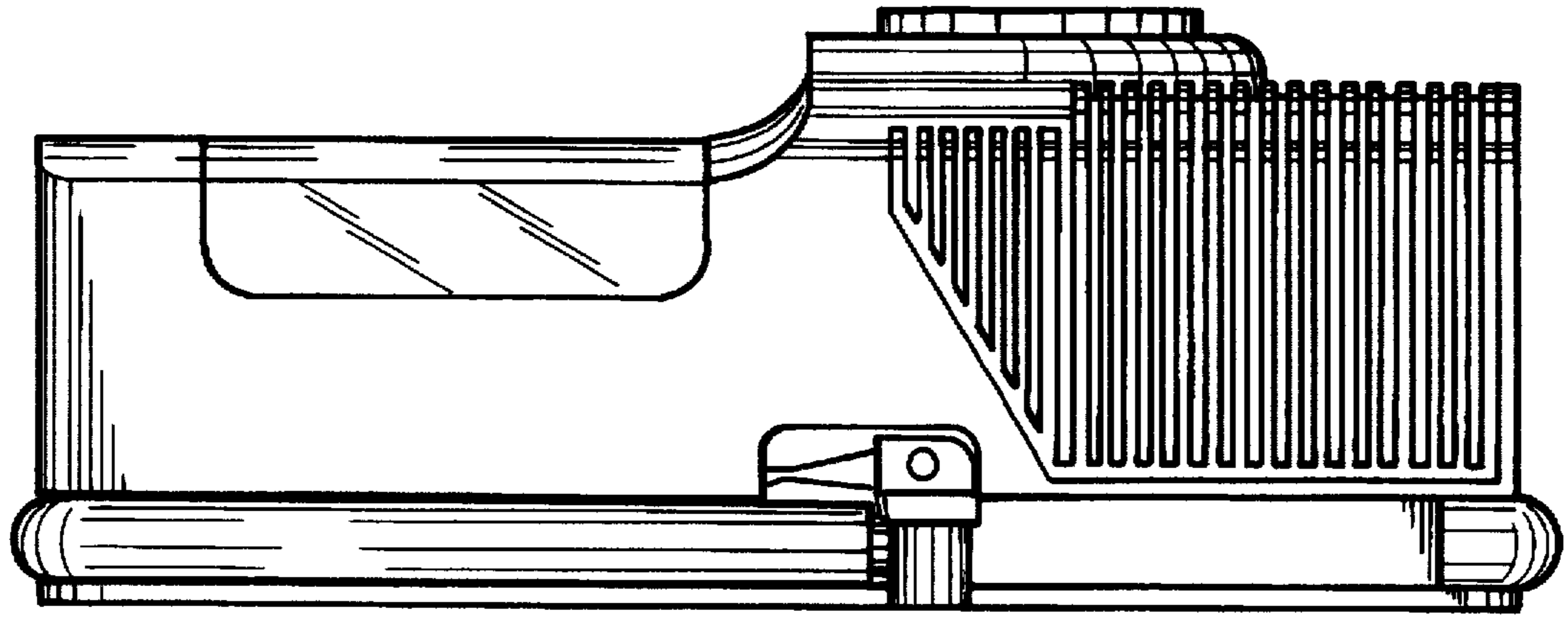

FIG. 5

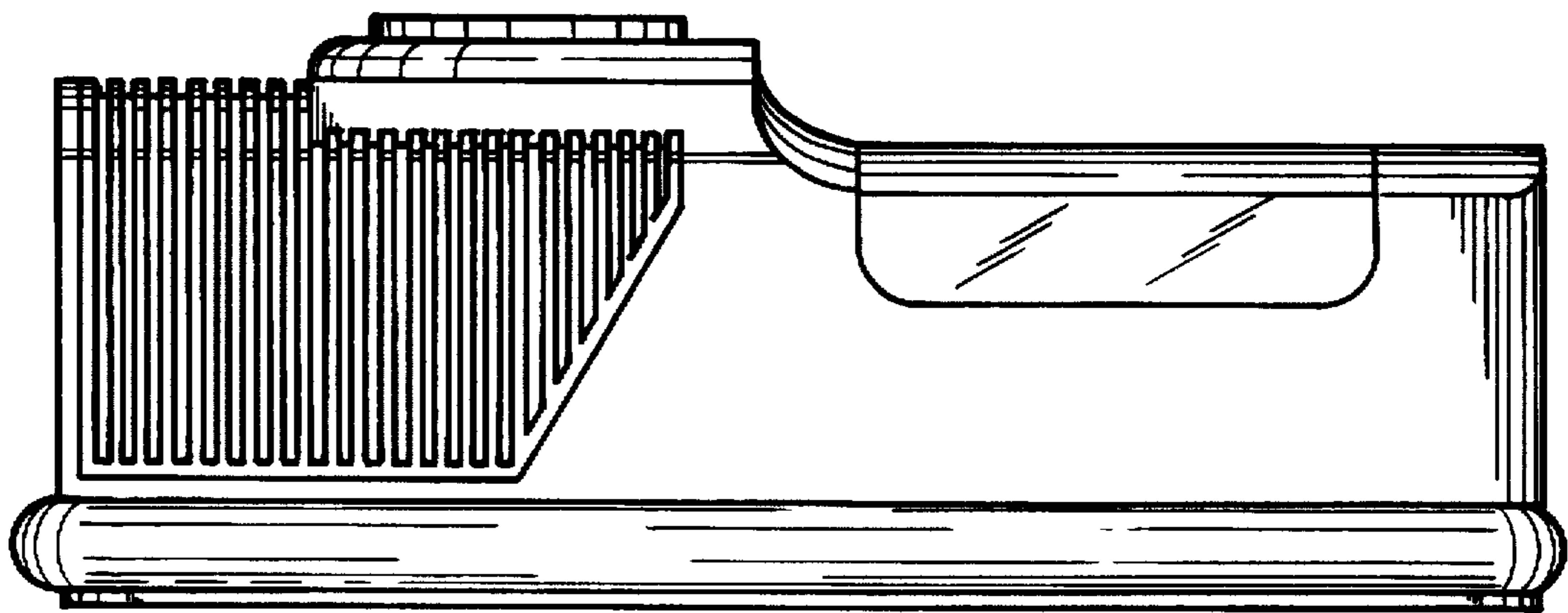

FIG. 6

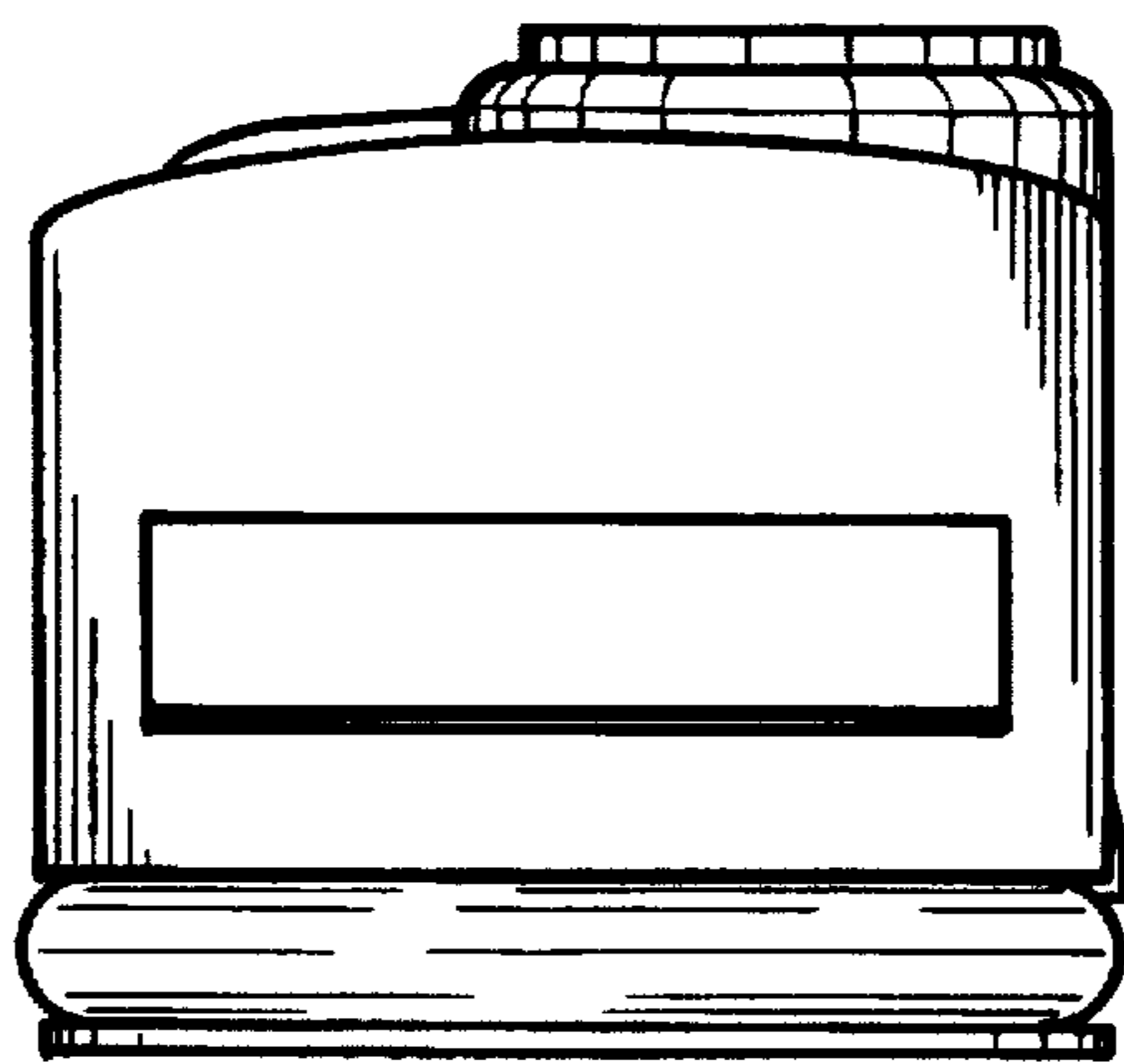

FIG. 7

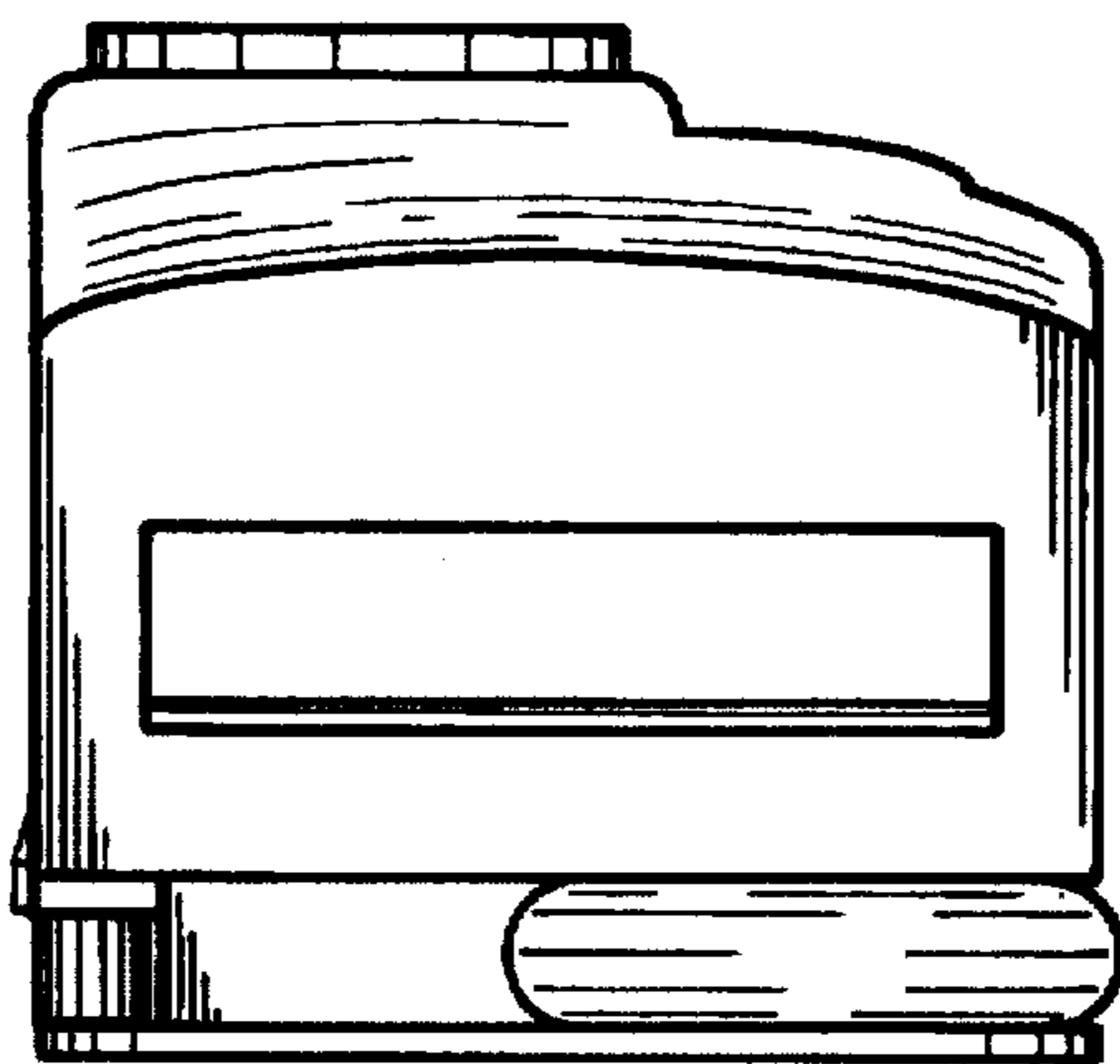

FIG. 8