



US00D395008S

United States Patent [19]

[11] Patent Number: **Des. 395,008**

Kuzma et al.

[45] Date of Patent: ****Jun. 9, 1998**

[54] **COMBINED BOTTLE AND CAP**

[75] Inventors: **Gene J. Kuzma; Douglas W. Weaver,**
both of Columbus, Ohio

[73] Assignee: **G.K. Packaging, Inc.,** Columbus, Ohio

[**] Term: **14 Years**

[21] Appl. No.: **71,092**

[22] Filed: **May 20, 1997**

[51] LOC (6) Cl. **09-01**

[52] U.S. Cl. **D9/538; D9/503; D9/556**

[58] Field of Search **D9/538-541, 556,**
D9/500, 503, 545, 559, 454, 435, 452;
215/382, 383, 384, 400

[56] **References Cited**

U.S. PATENT DOCUMENTS

D. 188,074	5/1960	Wunderly	D9/500
D. 213,421	3/1969	Leary	D9/556 X
D. 214,423	6/1969	Linn	D9/538
D. 234,292	2/1975	Plummer	D9/500
D. 241,713	10/1976	Plummer	D9/500
D. 254,841	4/1980	Neu	D9/503
D. 366,620	1/1996	Kuzma et al.	D9/542
D. 379,151	5/1997	Stevens	D9/503

Primary Examiner—Lucy Lieberman
Attorney, Agent, or Firm—John L. Gray; Kegler, Brown Hill & Ritter

[57] **CLAIM**

The ornamental design for a combined bottle and cap, as shown and described.

DESCRIPTION

FIG. 1 is a front elevation of a combined bottle and cap showing our new design;
 FIG. 2 is a top plan view thereof;
 FIG. 3 is a bottom plan view thereof;
 FIG. 4 is a front elevation of a second embodiment of the combined bottle and cap, which is the same as the first embodiment except for the cap;
 FIG. 5 is a top plan view thereof;
 FIG. 6 is a bottom plan view thereof;
 FIG. 7 is a front elevation of a third embodiment of the combined bottle and cap which is the same as the first two embodiments except for the cap;
 FIG. 8 is a top plan view thereof; and,
 FIG. 9 is a bottom plan view thereof.
 The rear and side views of the three embodiments of the combined bottle and cap are the same as the front views shown in FIGS. 1, 4 and 7.

1 Claim, 3 Drawing Sheets

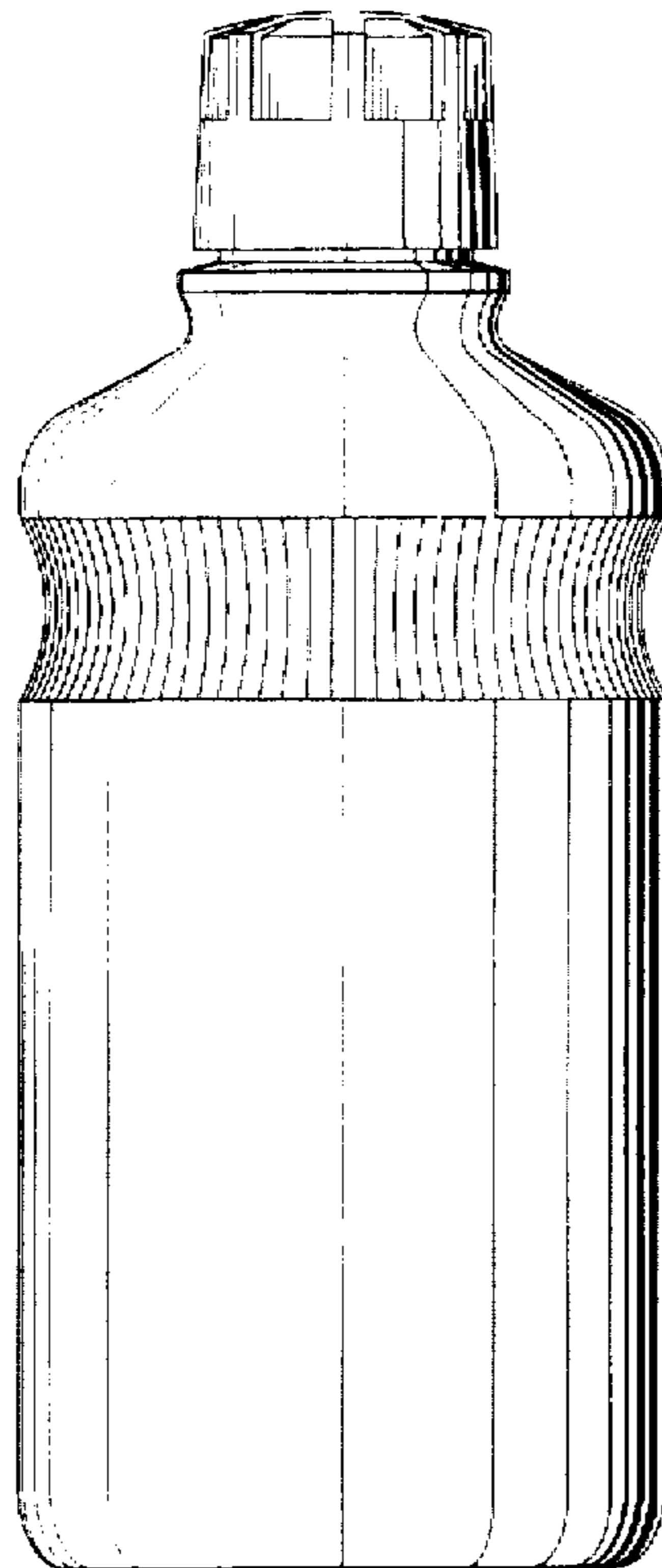

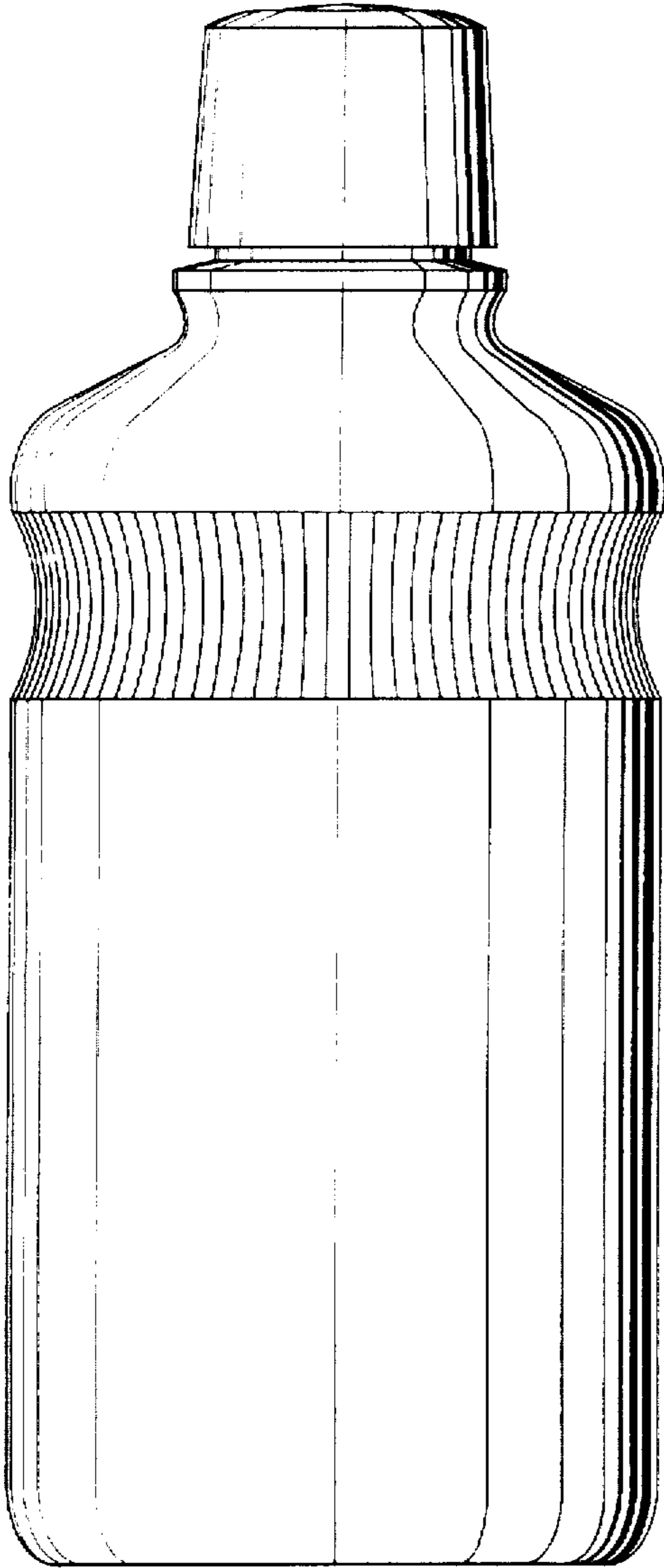

FIG. 1

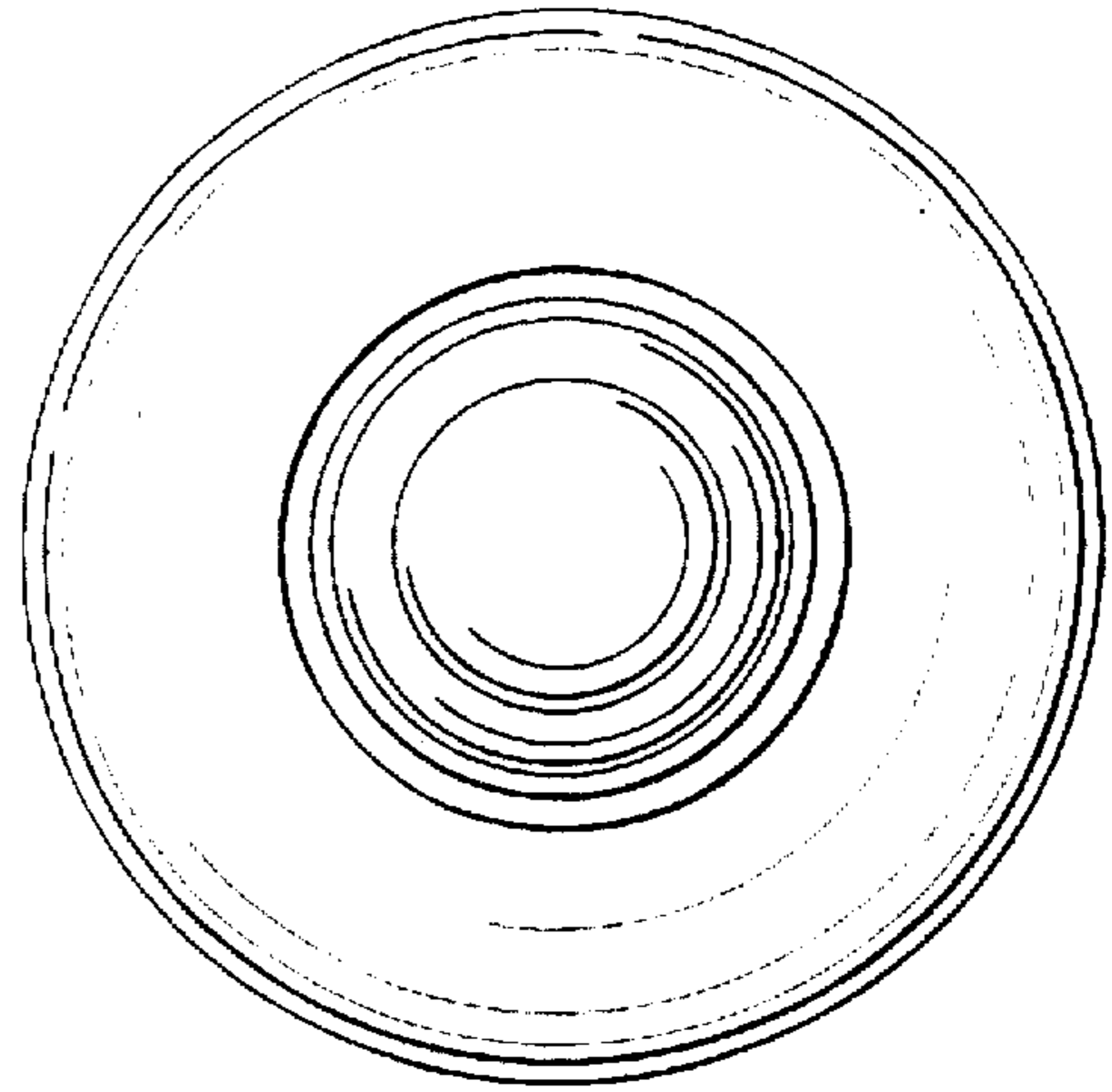

FIG. 2

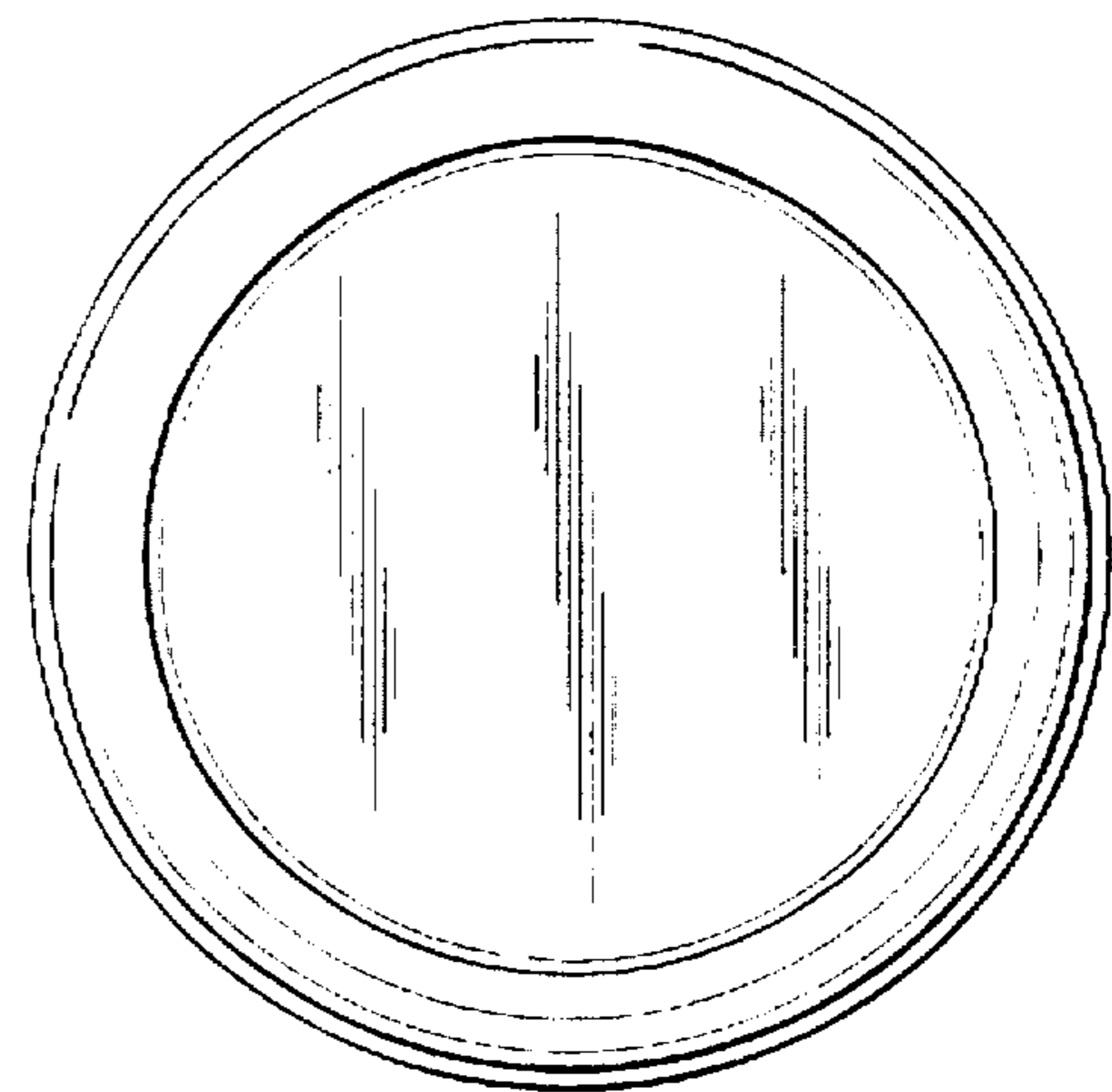

FIG. 3

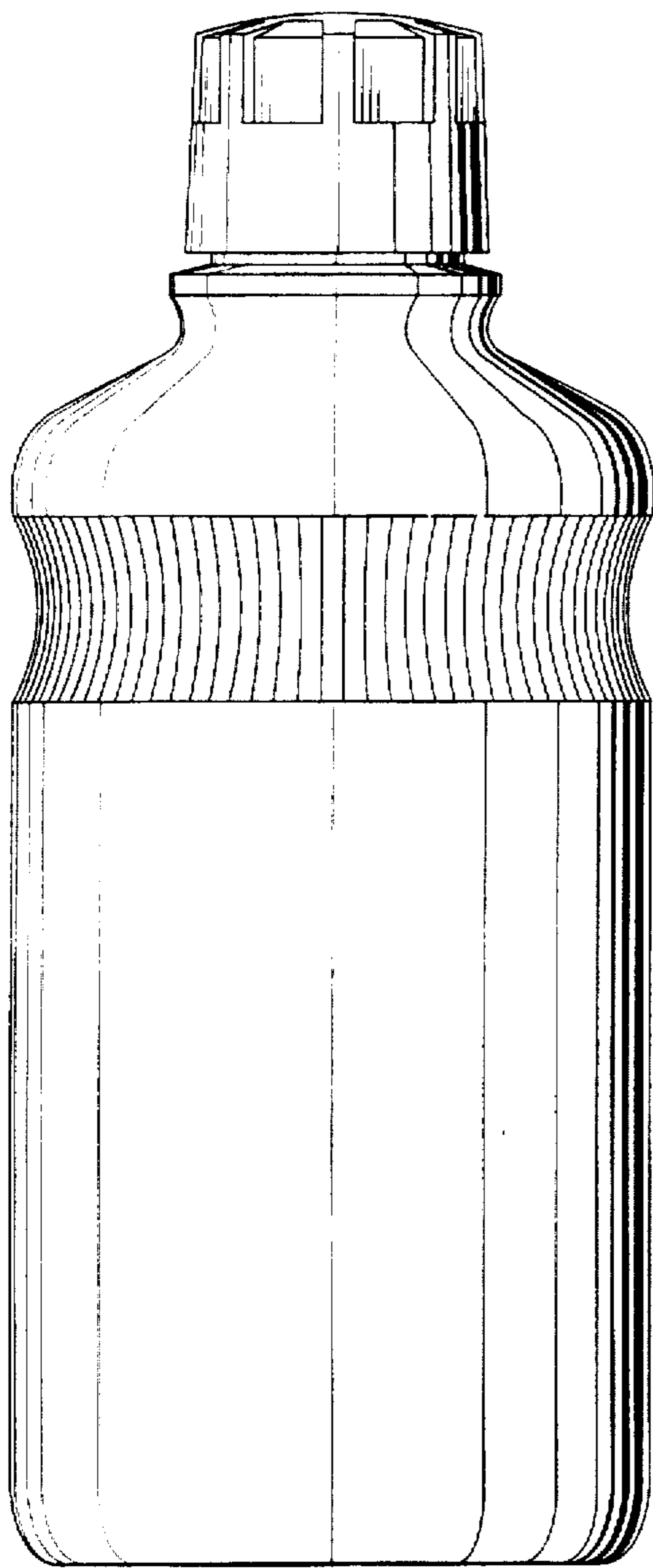

FIG. 4

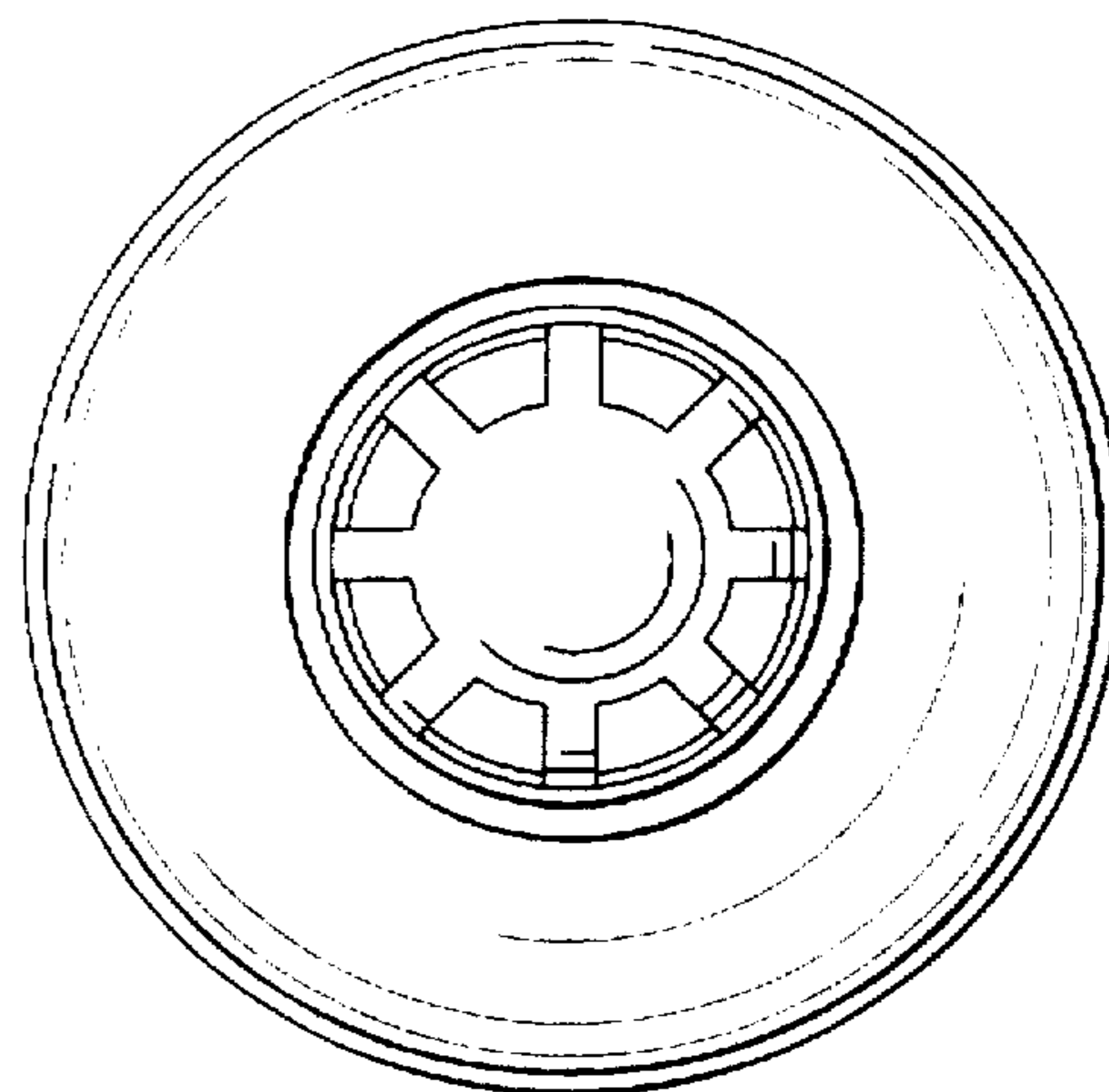

FIG. 5

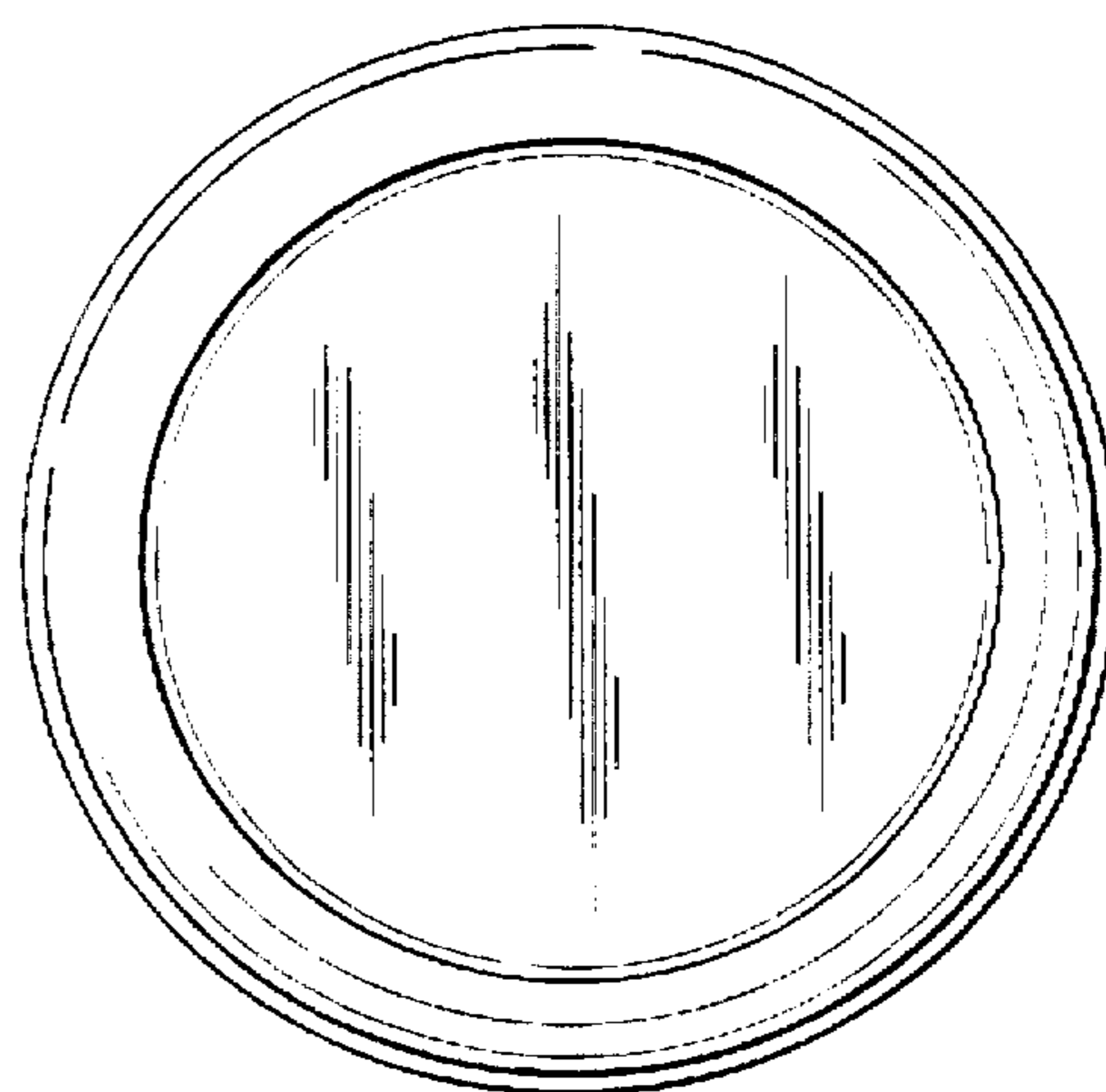

FIG. 6

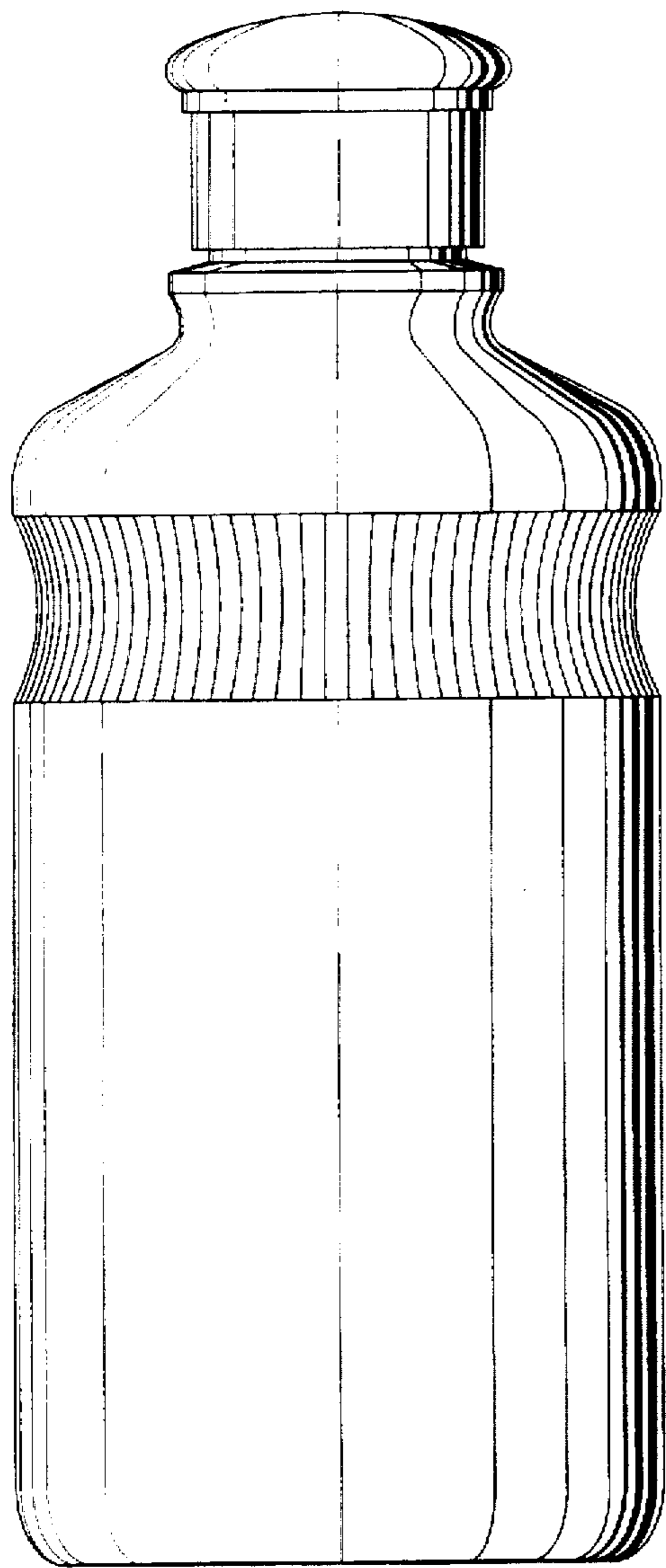

FIG. 7

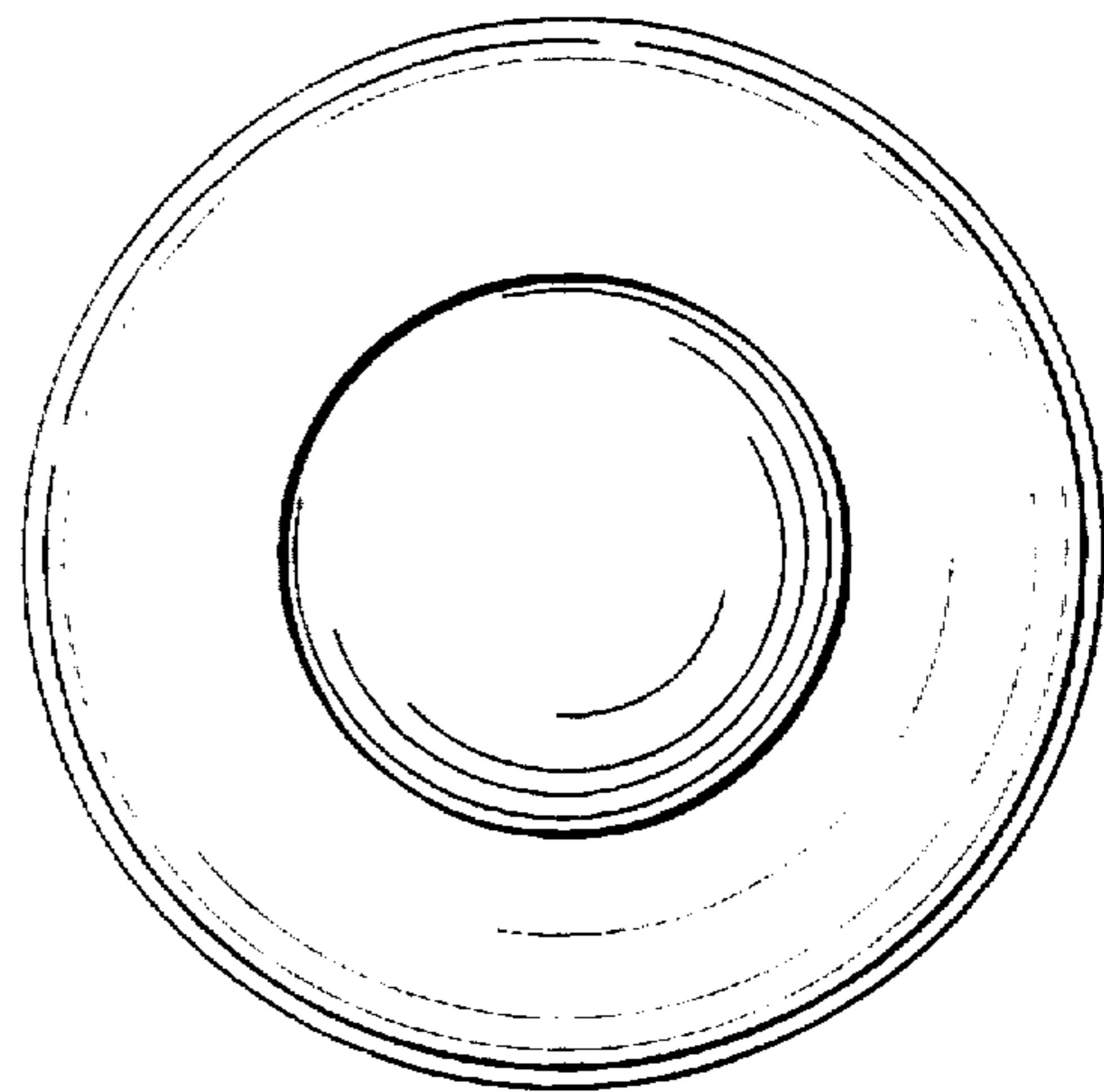

FIG. 8

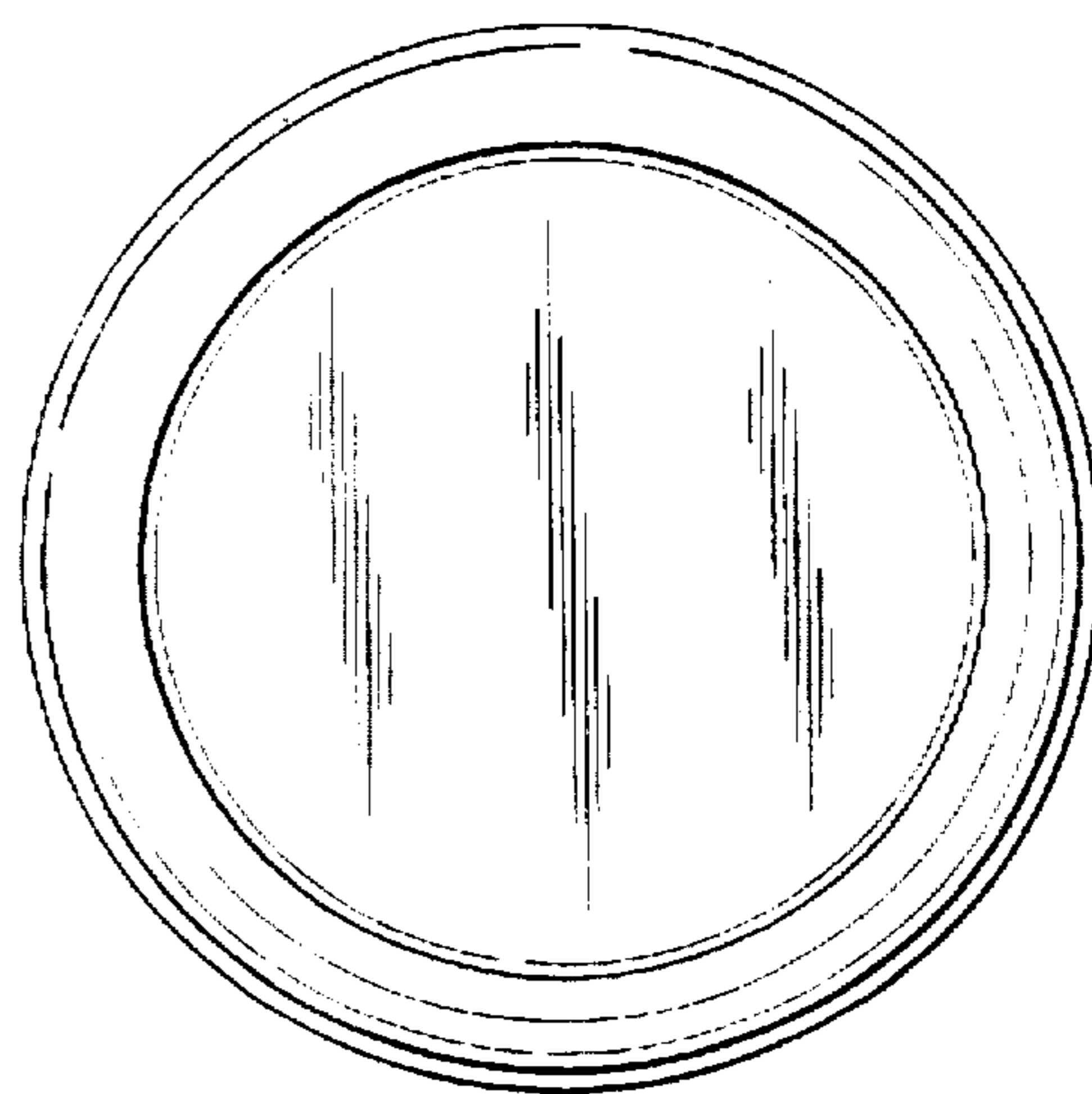

FIG. 9