



US00D394983S

United States Patent [19]
Garrett et al.

[11] **Patent Number:** **Des. 394,983**
[45] **Date of Patent:** ****Jun. 9, 1998**

[54] **TOASTER**

D. 375,017 10/1996 Barrault D7/330

[75] **Inventors:** **Barbara Garrett**, South Miami, Fla.;
Chi Kin Mak, Wan Chan, Rep. of
Korea

Primary Examiner—Caron D. Veynar
Attorney, Agent, or Firm—Dickstein Sharpapiro Morin &
Oshinsky LLP

[73] **Assignee:** **Windmere-Durable Holdings, Inc.**,
Miami Lakes, Fla.

[57] **CLAIM**

The ornamental design for a toaster, as shown and described.

[**] **Term:** **14 Years**

DESCRIPTION

[21] **Appl. No.:** **64,820**

FIG. 1 is a top, front and left perspective view of a toaster showing our new design;

[22] **Filed:** **Jan. 10, 1997**

FIG. 2 is a front view thereof;

[51] **LOC (6) CL** **07-02**

FIG. 3 is a back view thereof;

[52] **U.S. Cl.** **D7/330**

FIG. 4 is a top view thereof;

[58] **Field of Search** D7/323, 328-330;
99/327, 341, 372, 385, 389, 391, 392

FIG. 5 is a bottom view thereof;

FIG. 6 is a left side view thereof; and,

FIG. 7 is a right side view thereof.

[56] **References Cited**

U.S. PATENT DOCUMENTS

D. 345,074 3/1994 Myers et al. D7/330

1 Claim, 7 Drawing Sheets

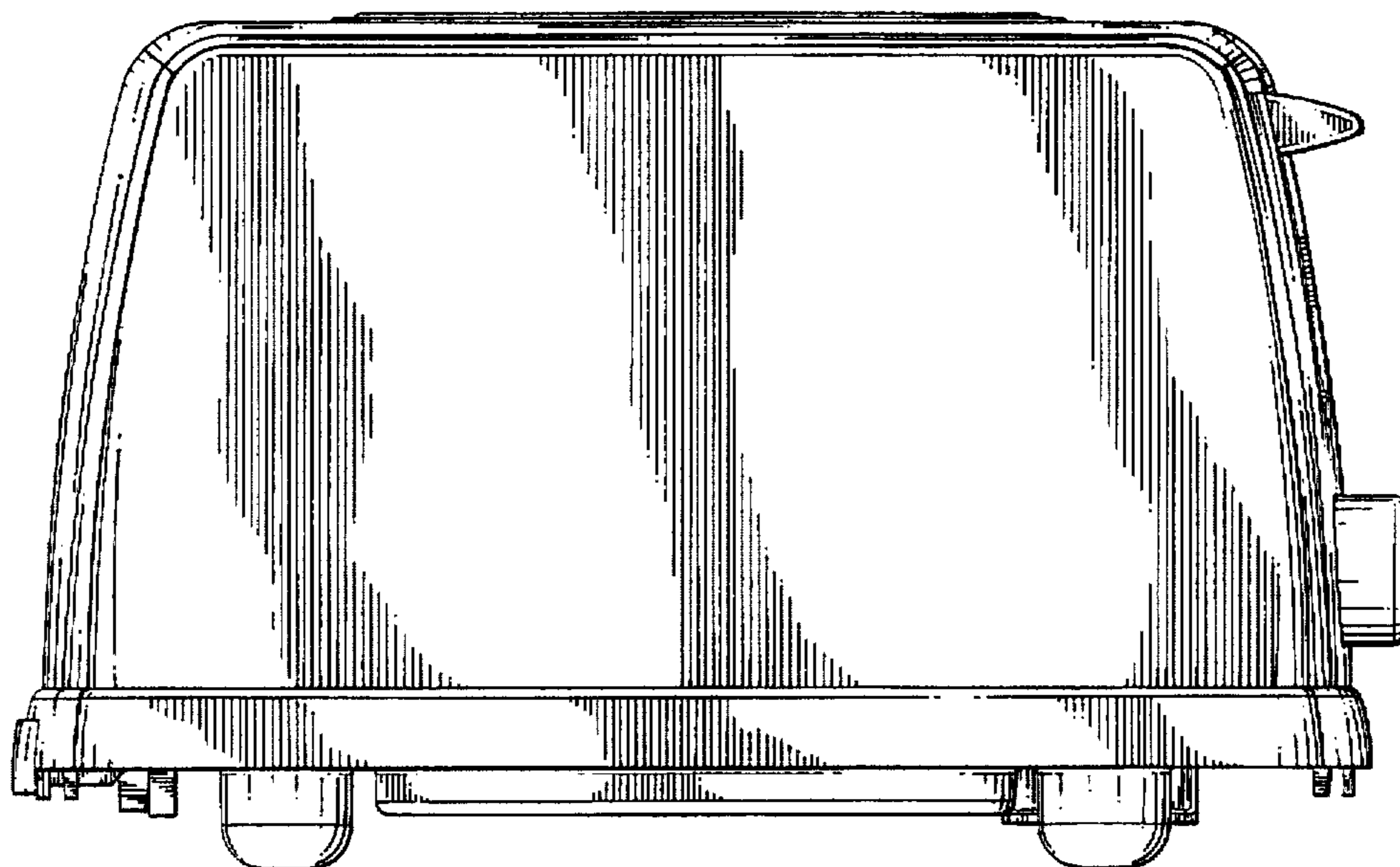

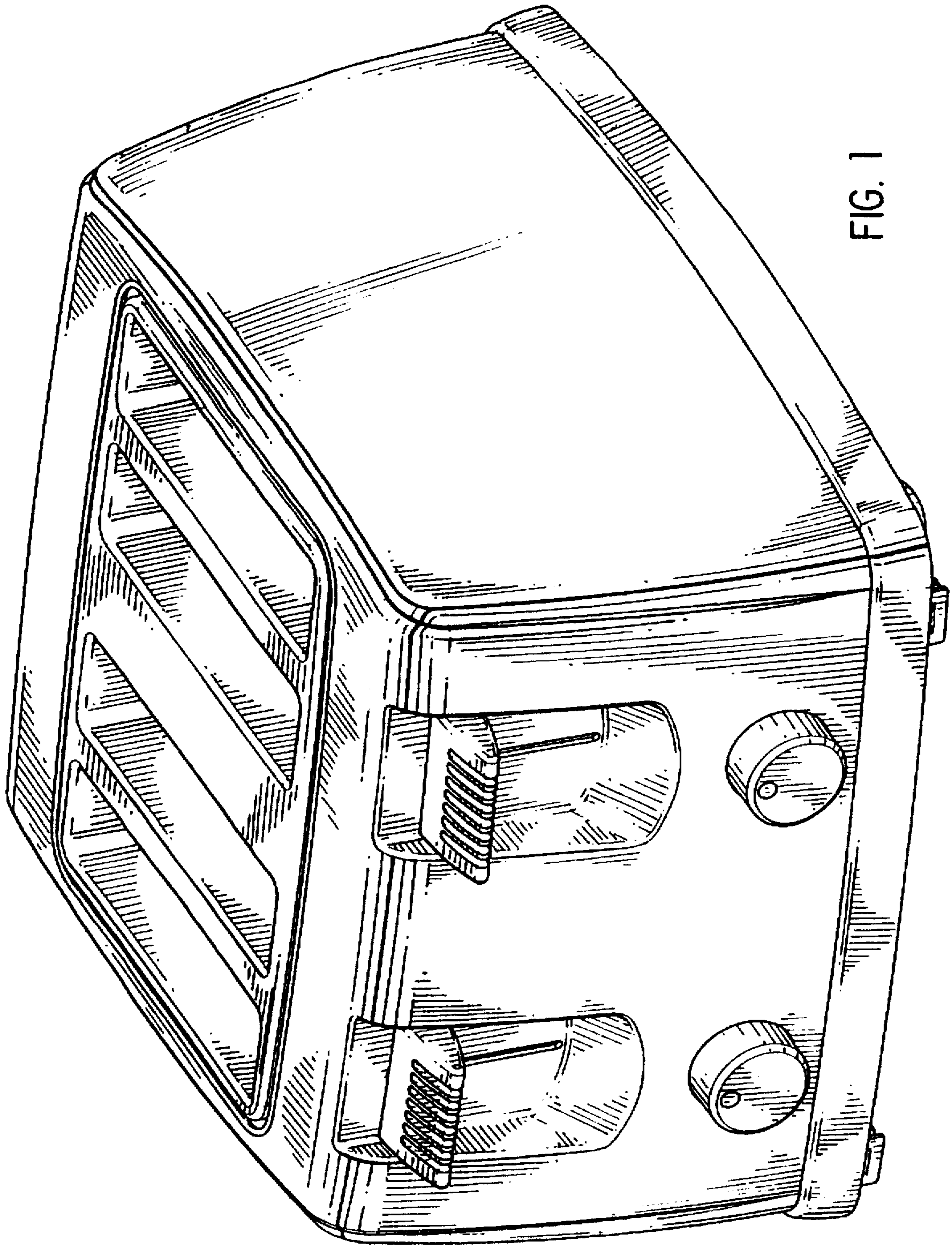

FIG. 1

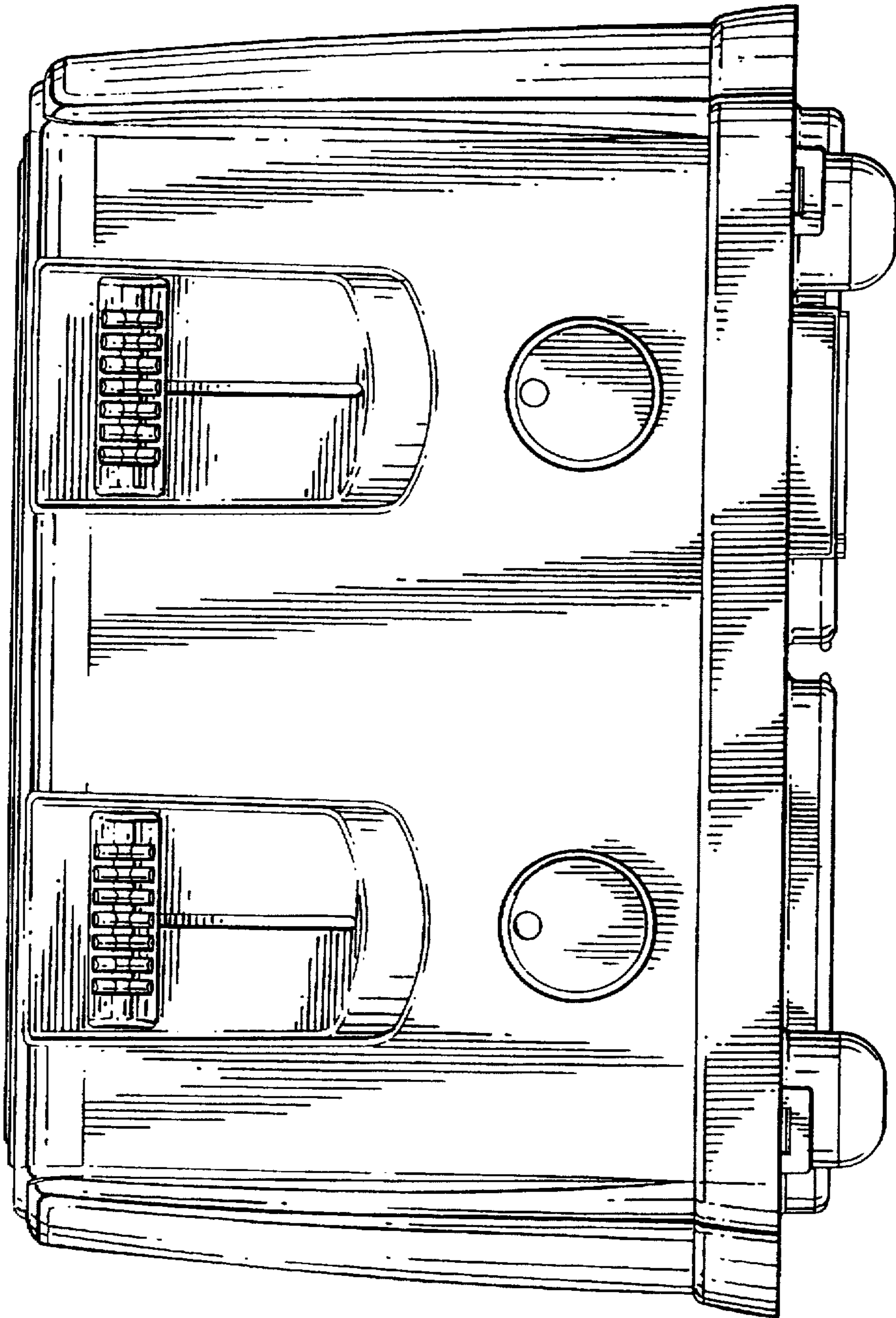

FIG. 2

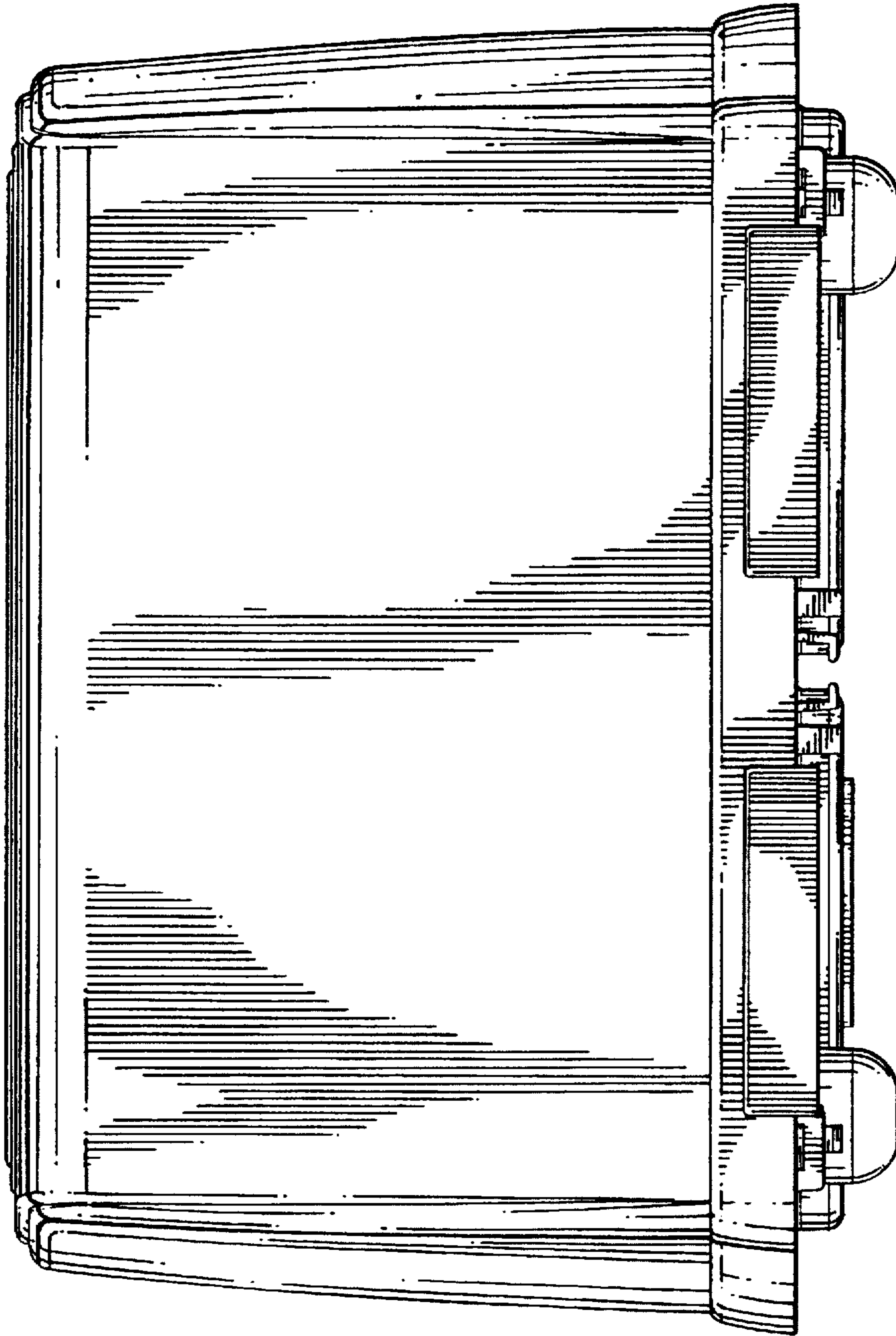

FIG. 3

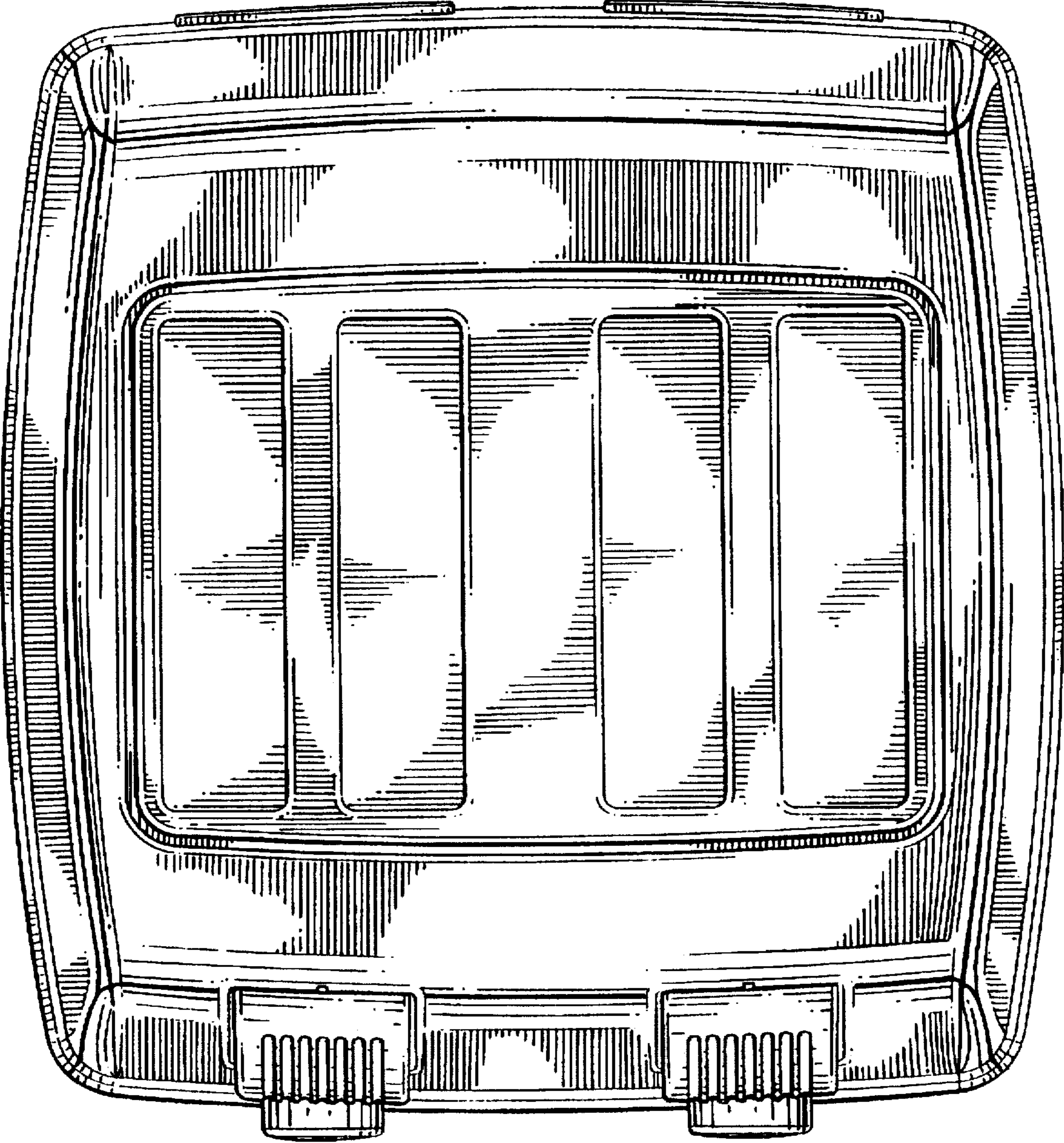

FIG. 4

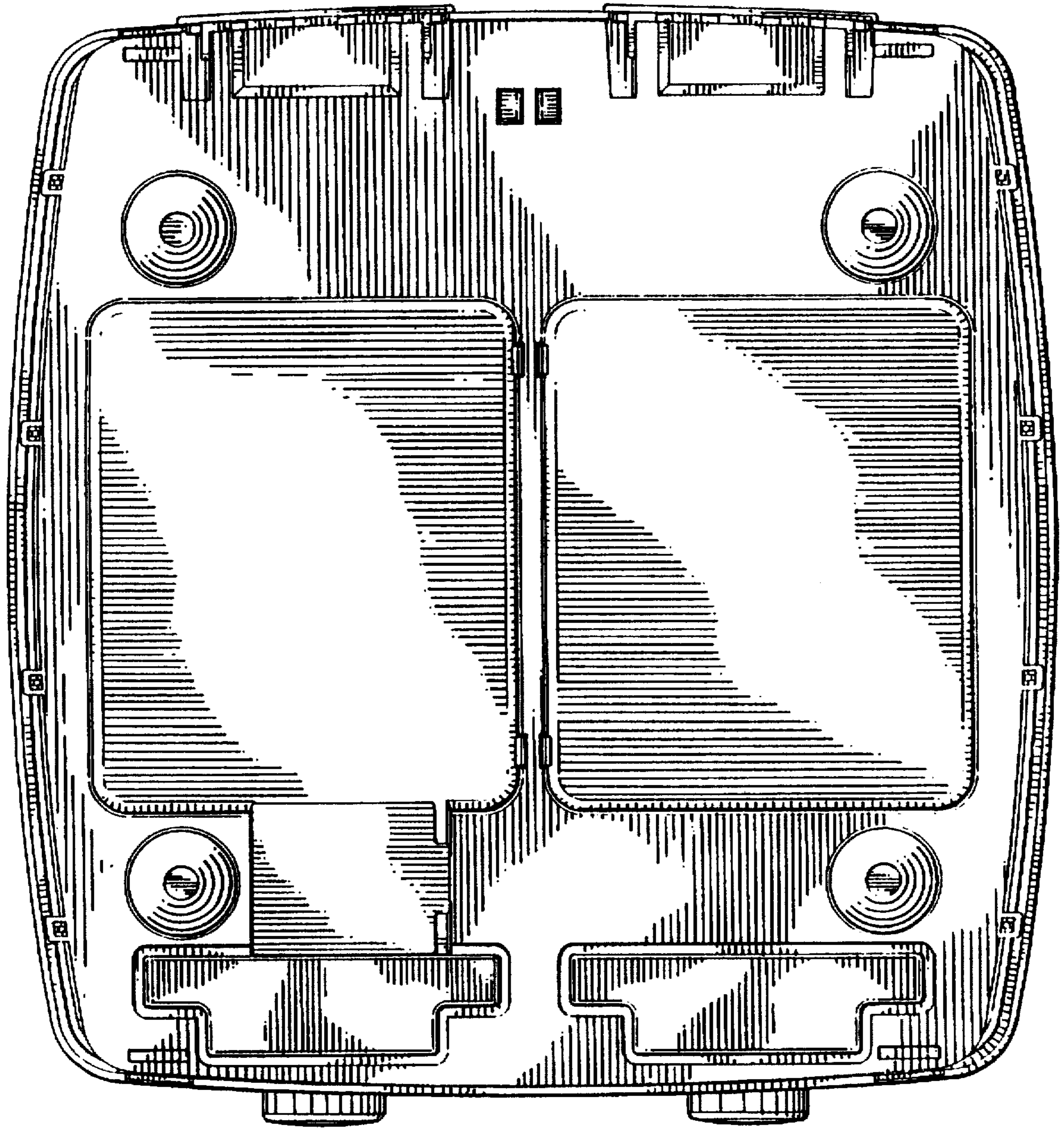

FIG. 5

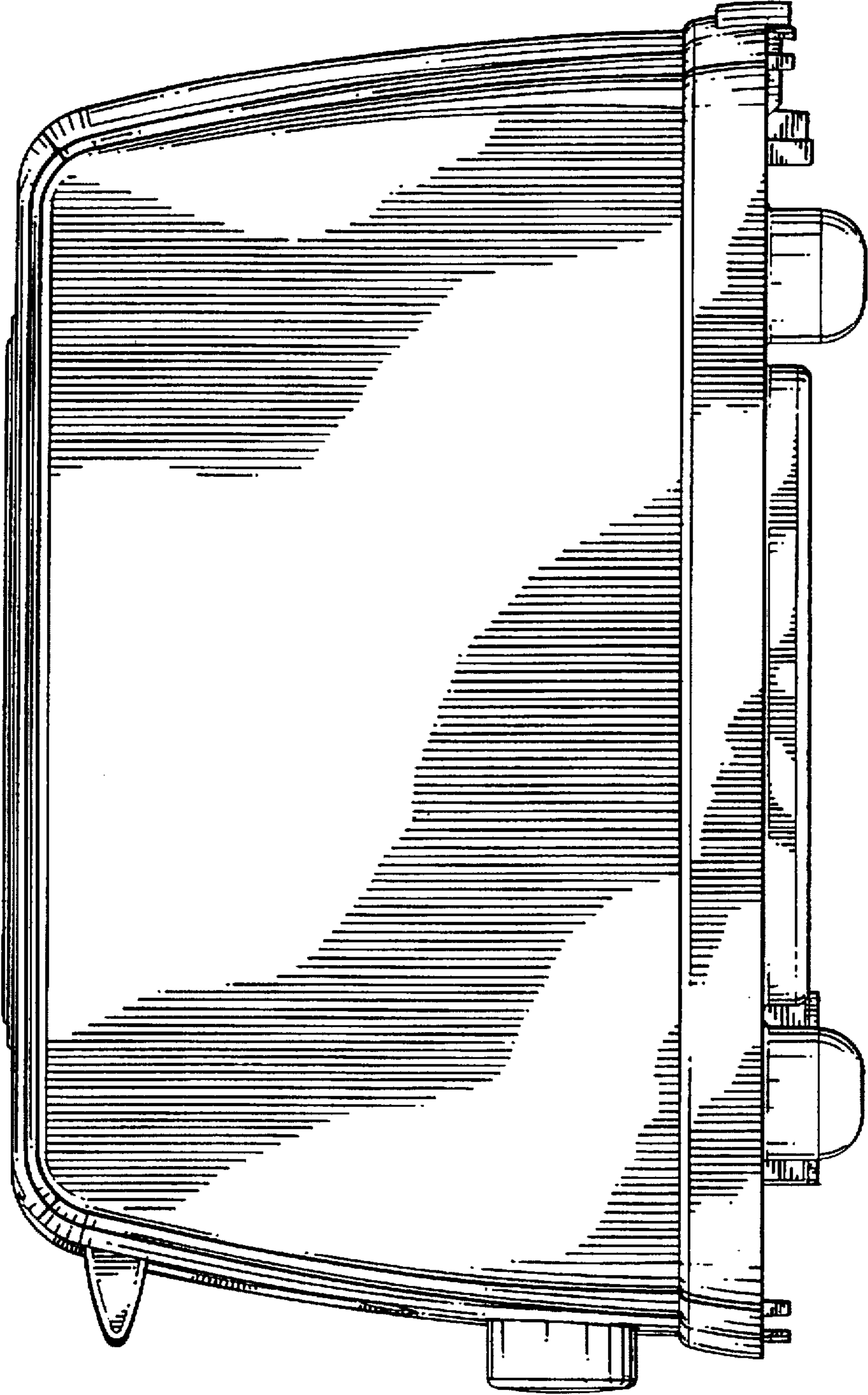

FIG. 6

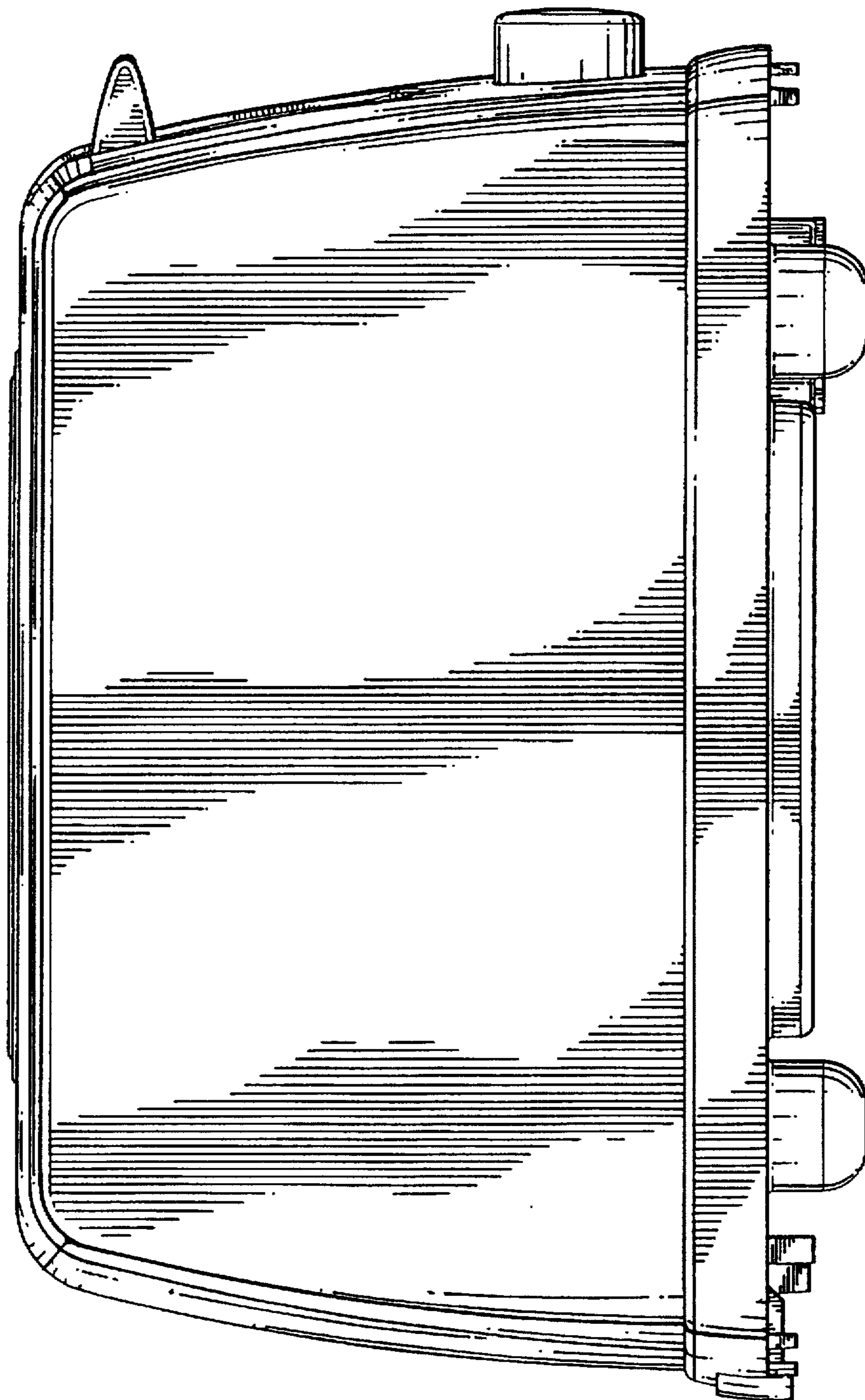

FIG. 7