



US00D394970S

# United States Patent [19] Ho

[11] Patent Number: **Des. 394,970**

[45] Date of Patent: **\*\*Jun. 9, 1998**

[54] **WOODEN TOWEL RACK**

4,870,907 10/1989 McKee ..... 211/90.1 X

[75] Inventor: **Tang-hsiung Ho**, Taipei, Taiwan

### OTHER PUBLICATIONS

[73] Assignee: **Test Rite International Co., Ltd.**,  
Taipei, Taiwan

MäLeck Accessories, p. 30 ML1635 Single Towel Bar,  
1980.

[\*\*] Term: **14 Years**

*Primary Examiner*—Pamela J. Burgess  
*Attorney, Agent, or Firm*—Pro-Techtor International

[21] Appl. No.: **67,965**

### [57] CLAIM

[22] Filed: **Apr. 15, 1997**

The ornamental design for a wooden towel rack, as shown  
and described.

[51] **LOC (6) Cl.** ..... **07-06**

### DESCRIPTION

[52] **U.S. Cl.** ..... **D6/549; D6/524**

[58] **Field of Search** ..... D6/549, 523, 524,  
D6/518, 522, 546-550; 211/123, 124, 182,  
86-87, 105.1, 90.1; 242/570, 598

FIG. 1 is a perspective view showing the wooden towel rack  
in accordance with the present invention;  
FIG. 2 is a front elevational view thereof;  
FIG. 3 is a rear elevational view thereof;  
FIG. 4 is a left-hand side elevational view thereof;  
FIG. 5 is a right-hand side elevational view thereof;  
FIG. 6 is a top plan view thereof; and,  
FIG. 7 is a bottom plan view thereof.

### [56] References Cited

#### U.S. PATENT DOCUMENTS

D. 157,015	1/1950	Wheelan	.....	D6/549
D. 162,971	4/1951	Marchand	.....	D6/549
D. 361,006	8/1995	Sharpe	.....	D6/524
D. 377,570	1/1997	Sharpe	.....	D6/524
1,759,319	5/1930	Monroe	.....	211/105.1

The broken-away portion of the towel bar shown in FIGS.  
1, 2, 3, 6 and 7 represents an indeterminate length.

**1 Claim, 6 Drawing Sheets**

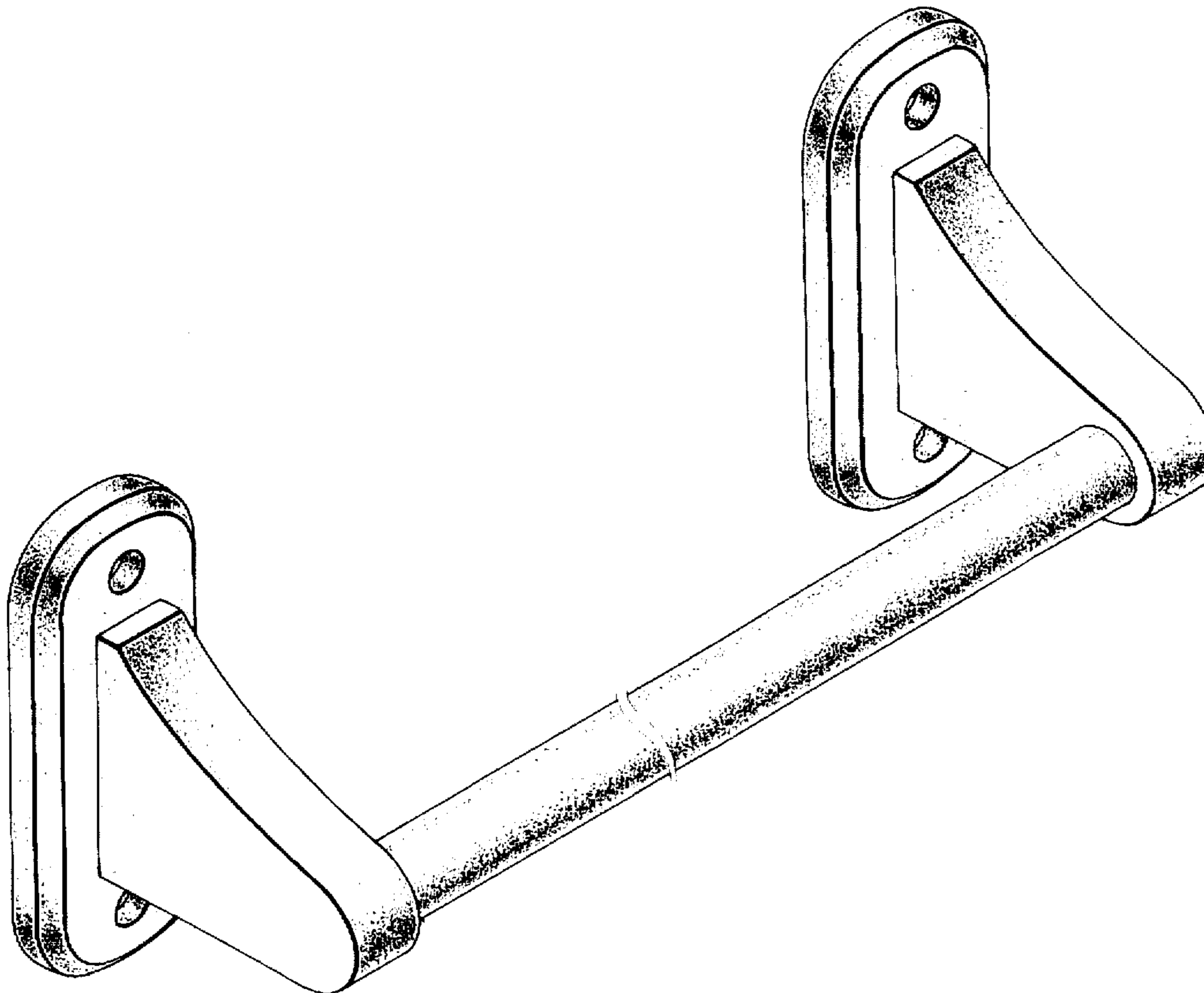

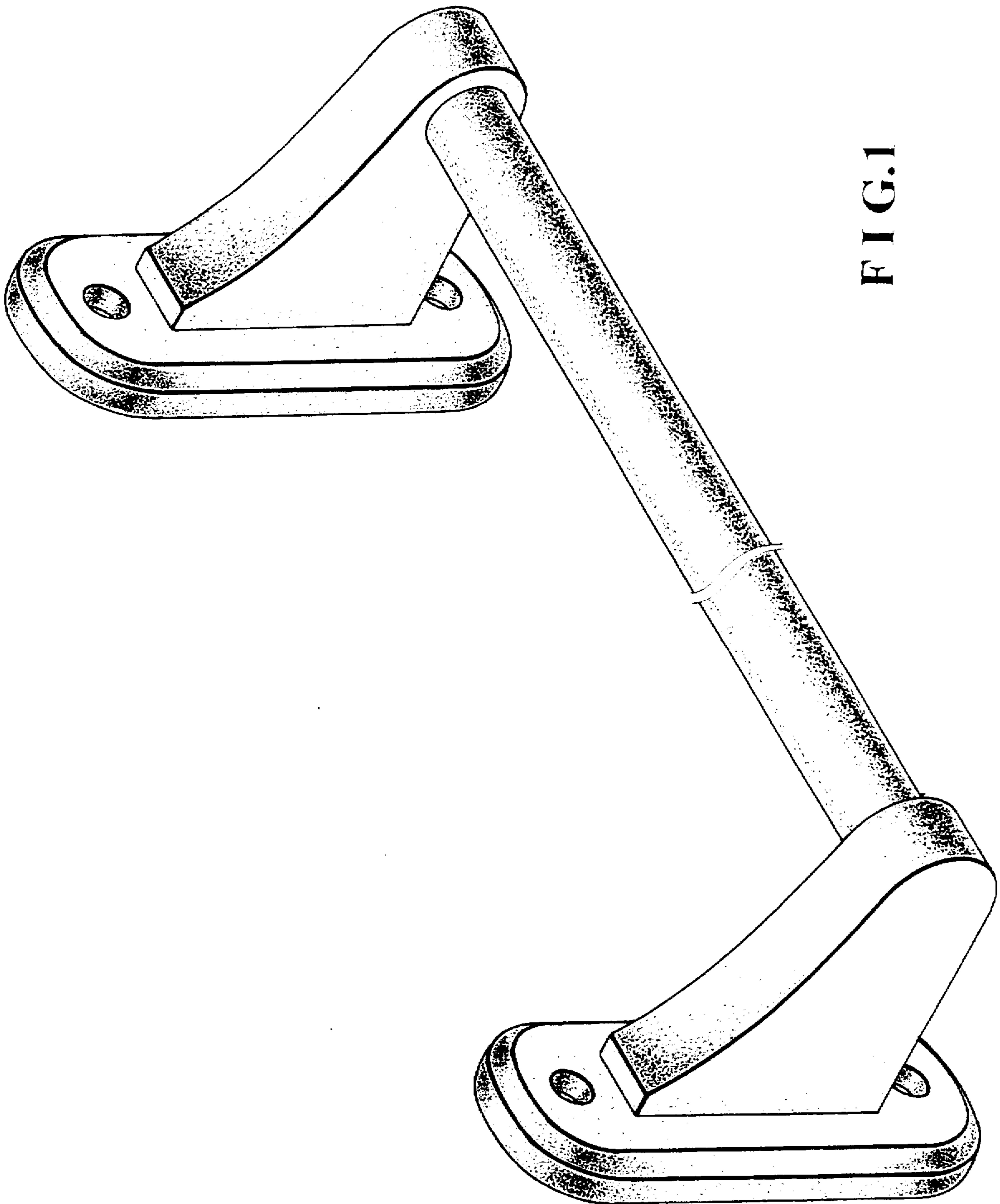

FIG. 1

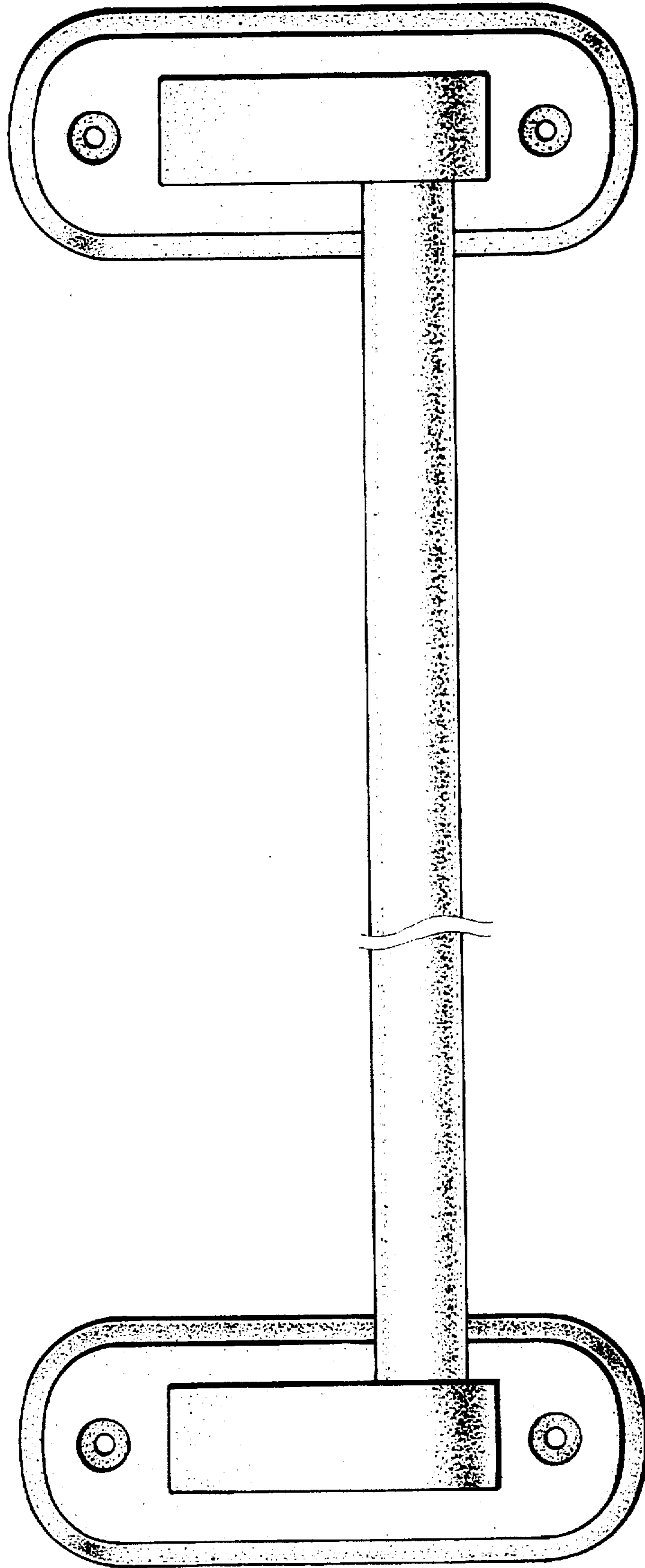

FIG. 2

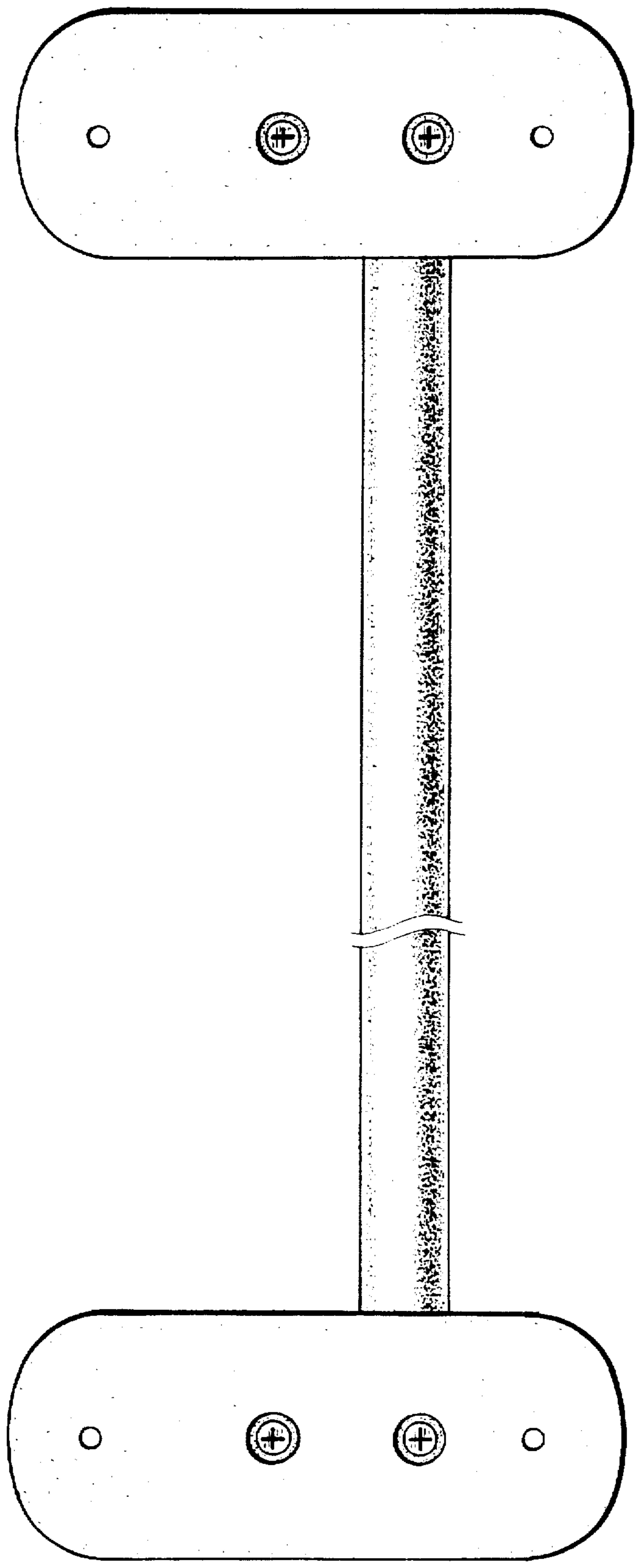

FIG.3

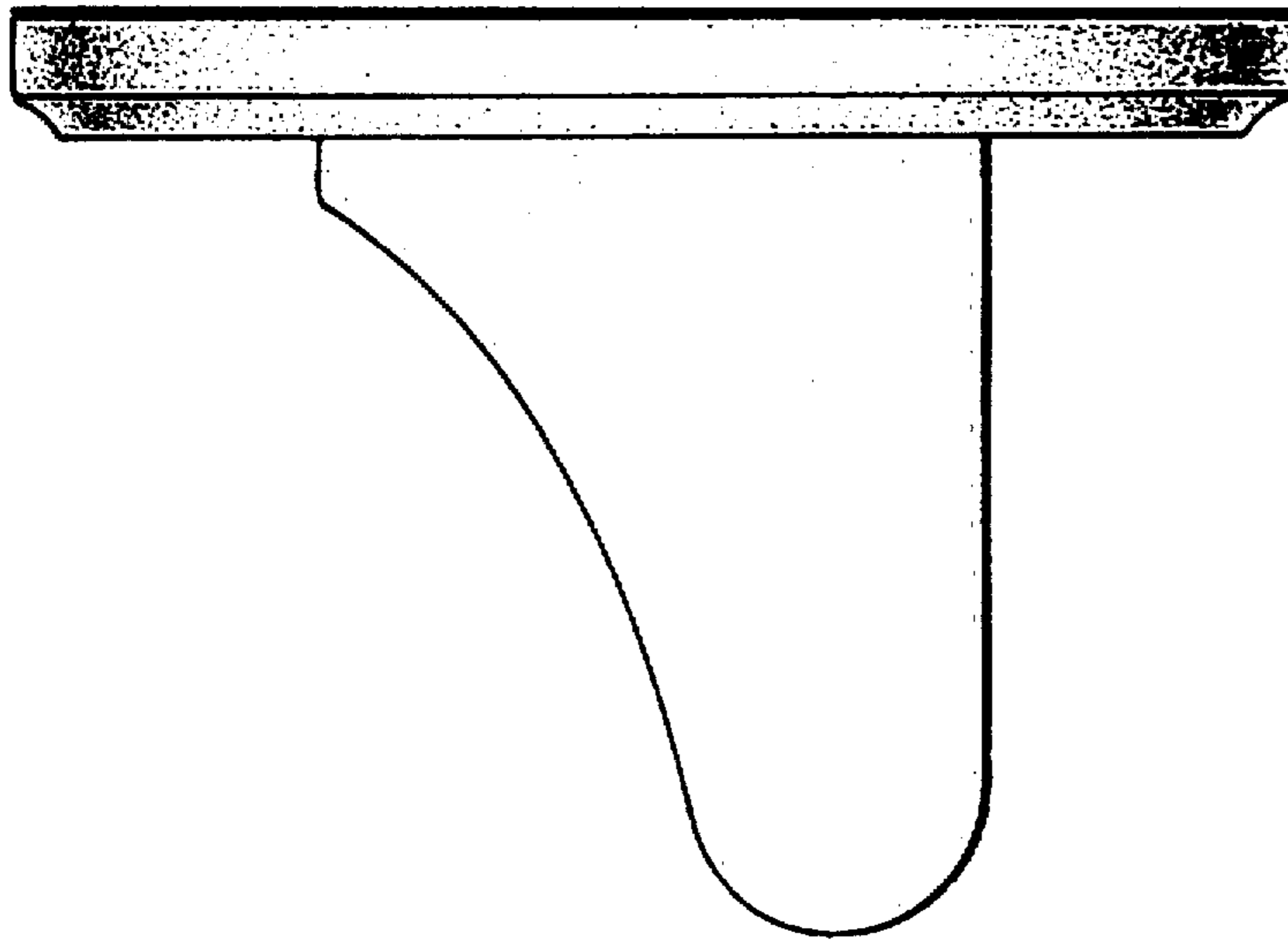

FIG.5

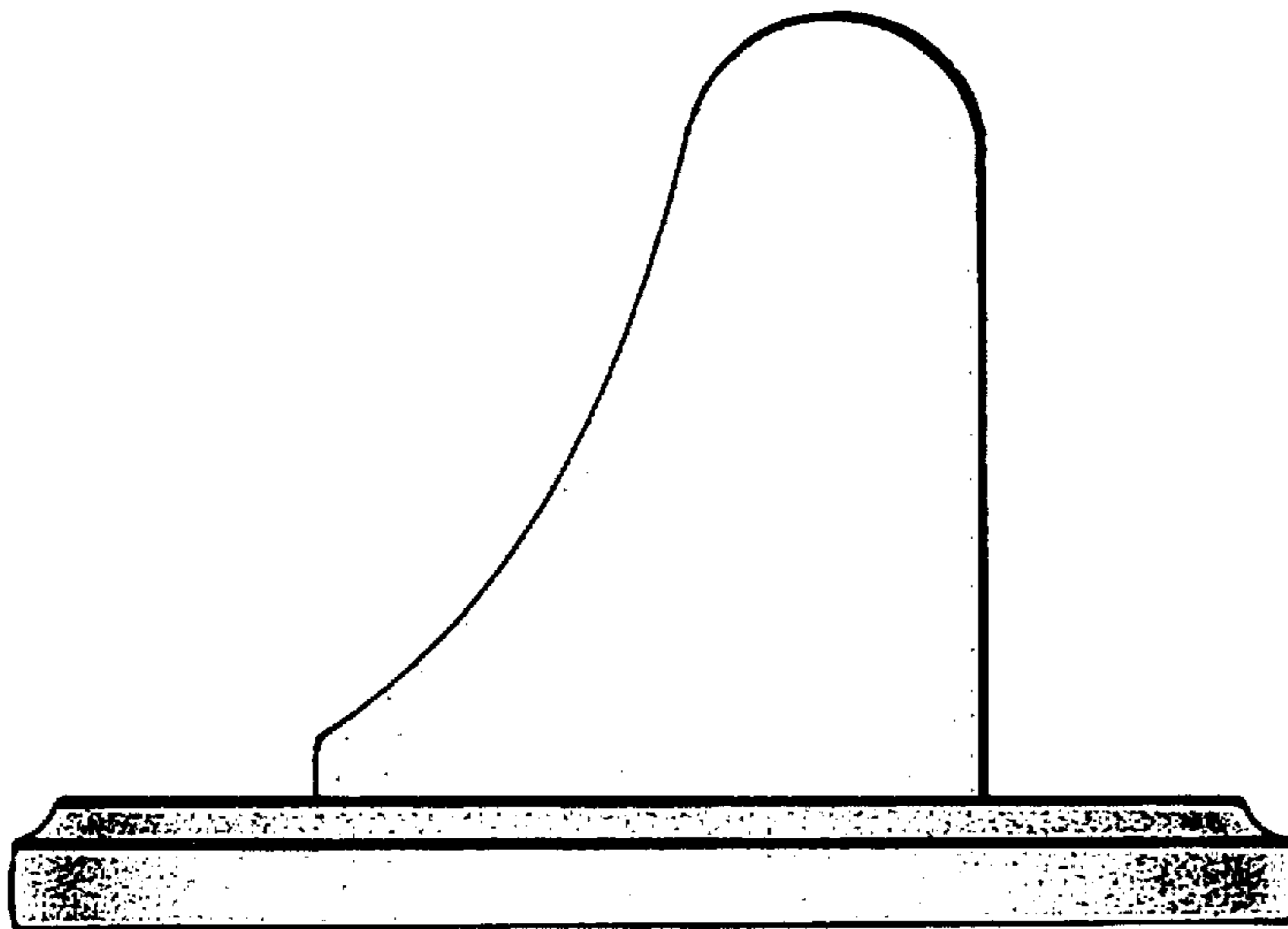

FIG.4

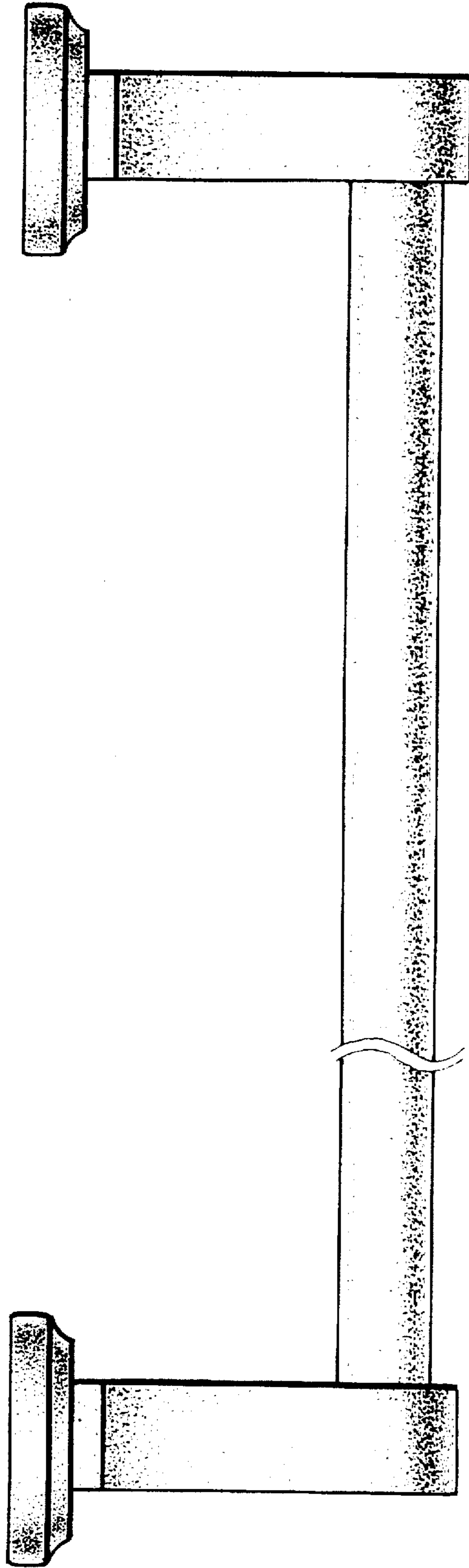

FIG. 6

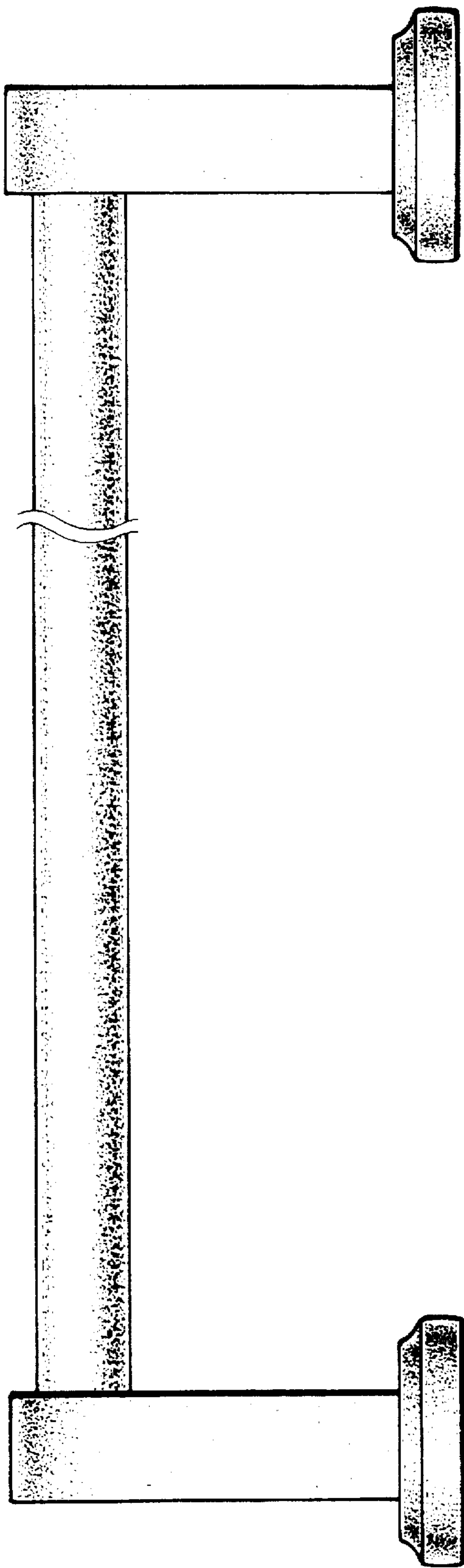

FIG. 7