



US00D394894S

# United States Patent [19]

Strawcutter et al.

[11] Patent Number: **Des. 394,894**

[45] Date of Patent: **\*\*Jun. 2, 1998**

[54] **MOLDED TRIANGULAR RECREATIONAL EQUIPMENT PLATFORM**

D. 353,868 12/1994 Houry et al. .... D21/240  
D. 370,959 6/1996 Houry ..... D21/240 X

[76] Inventors: **Grant M. Strawcutter**, 529 Dilworth Rd. West, Charlotte, N.C. 28203; **James O. Dunn, Jr.**, 416 N. Laurel Ave., Charlotte, N.C. 28204; **Jonathan E. Brooks**, 7000 Spandril La., Charlotte, N.C. 28215

*Primary Examiner*—Ted Shooman  
*Assistant Examiner*—Mitchell I. Siegel  
*Attorney, Agent, or Firm*—Polster, Lieder, Woodruff & Lucchesi, L.C.

[\*\*] Term: **14 Years**

[57] **CLAIM**

The ornamental design for molded triangular recreational equipment platform, as shown and described.

[21] Appl. No.: **55,331**

**DESCRIPTION**

[22] Filed: **Jun. 5, 1996**

FIG. 1 is a top perspective view of our molded triangular recreational equipment platform;  
FIG. 2 is a bottom perspective view thereof;  
FIG. 3 is a top plan view thereof;  
FIG. 4 is a bottom plan view thereof;  
FIG. 5 is a left side elevational view thereof;  
FIG. 6 is a rear side elevational view thereof; and,  
FIG. 7 is a right side elevational view thereof.

[51] LOC (6) Cl. .... **21-03**

[52] U.S. Cl. .... **D21/240**

[58] Field of Search ..... D21/240-245,  
D21/109; 482/35, 36; 446/124, 125, 314

[56] **References Cited**

**U.S. PATENT DOCUMENTS**

D. 334,610 4/1993 Aker ..... D21/244

**1 Claim, 2 Drawing Sheets**

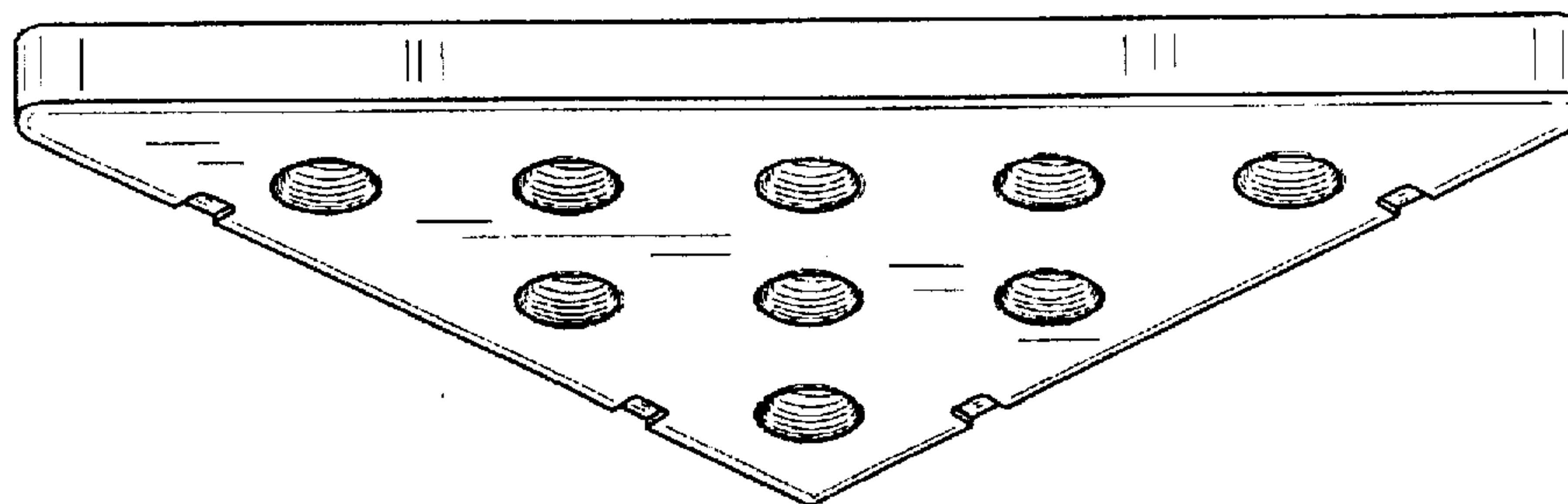

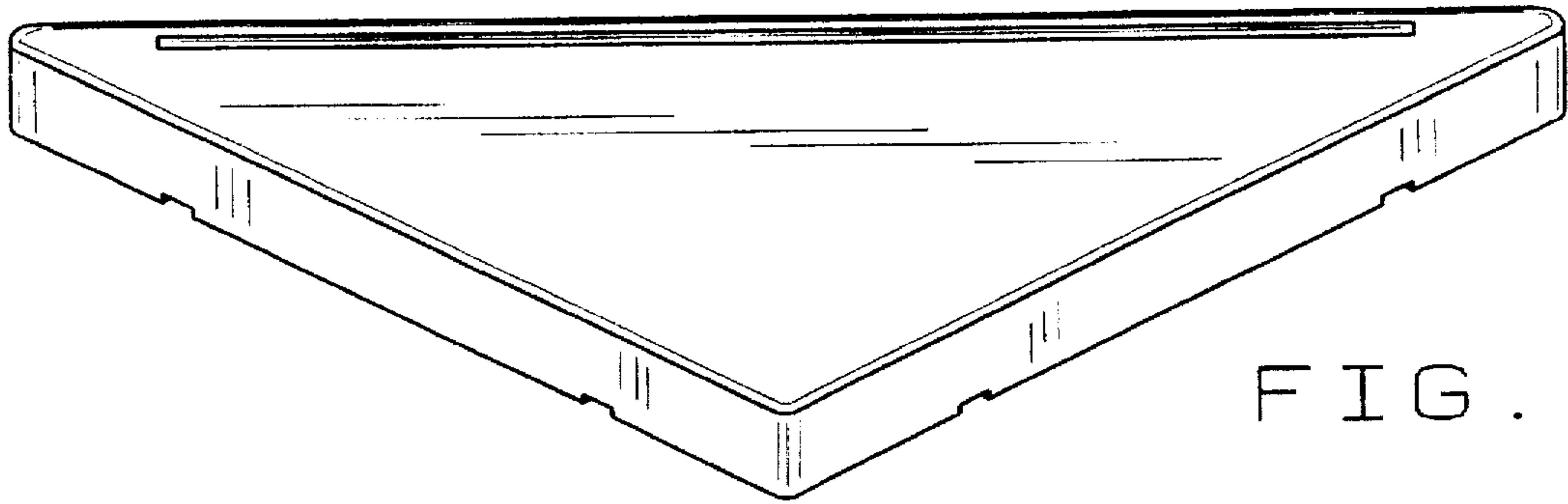

FIG. 1

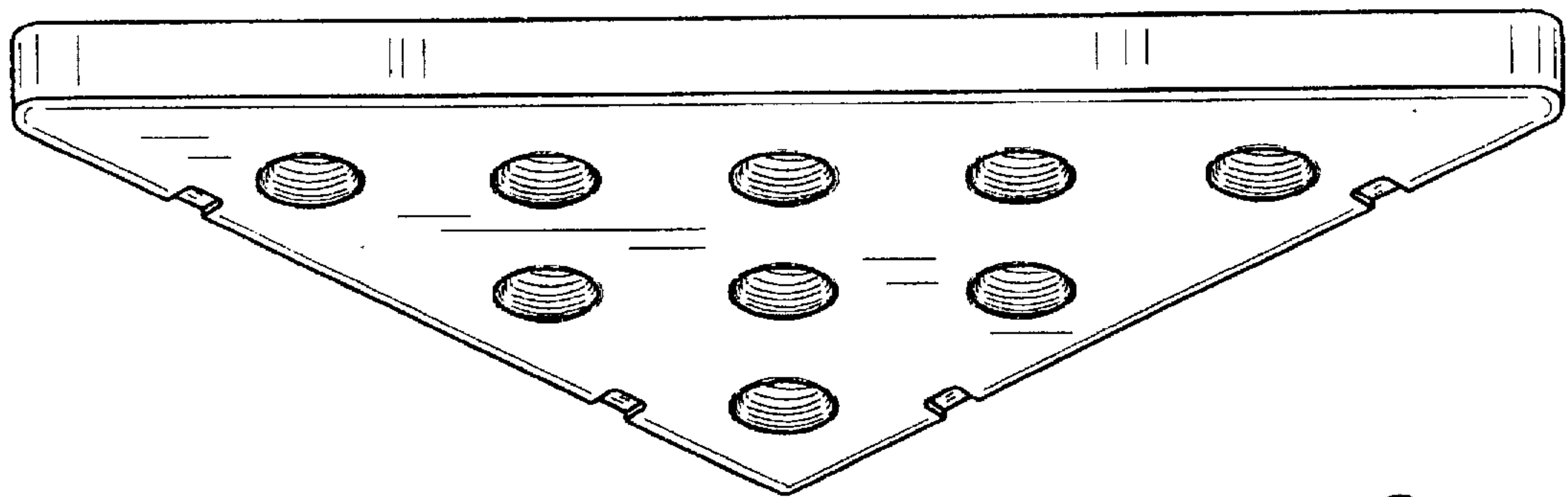

FIG. 2

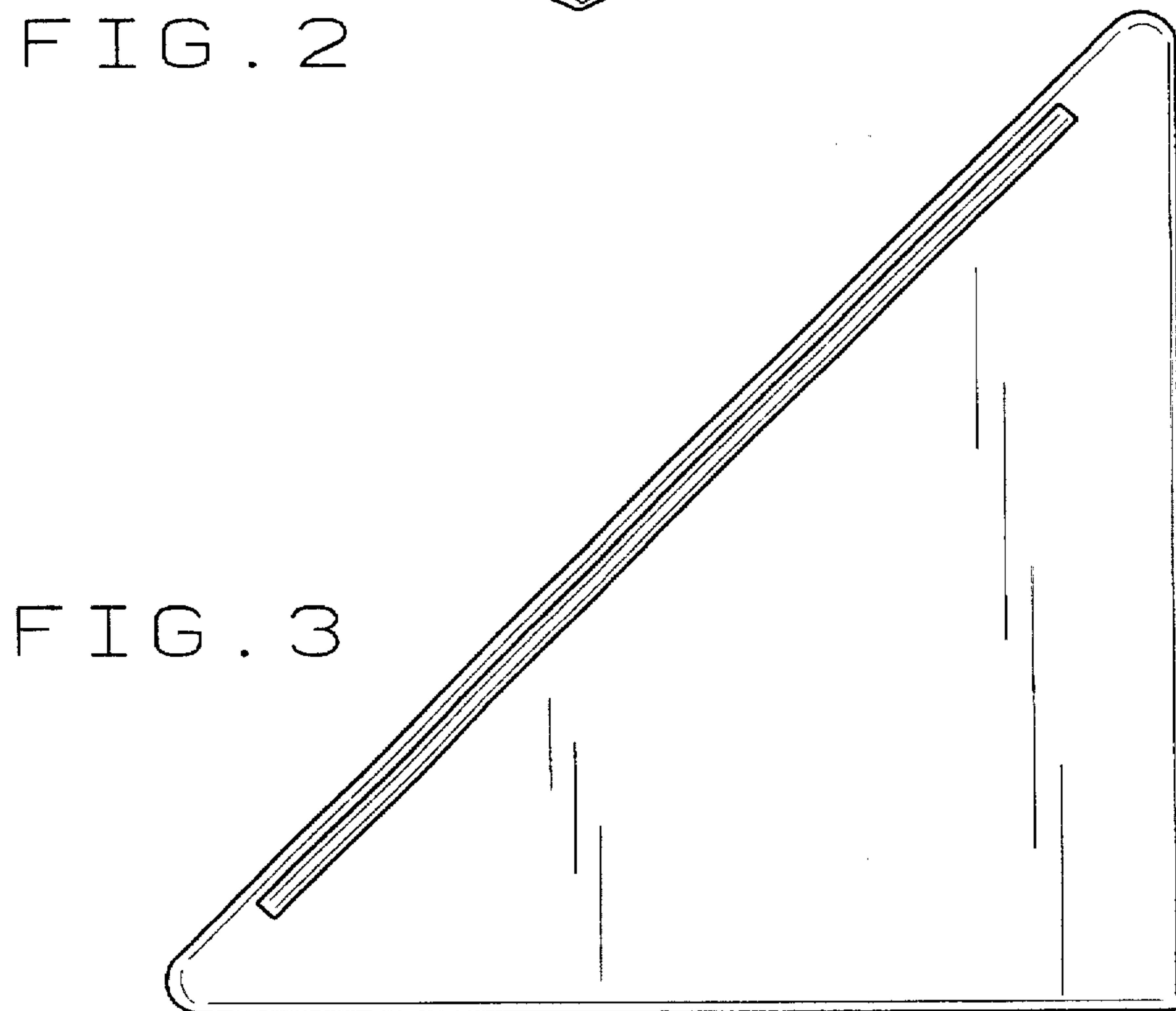

FIG. 3

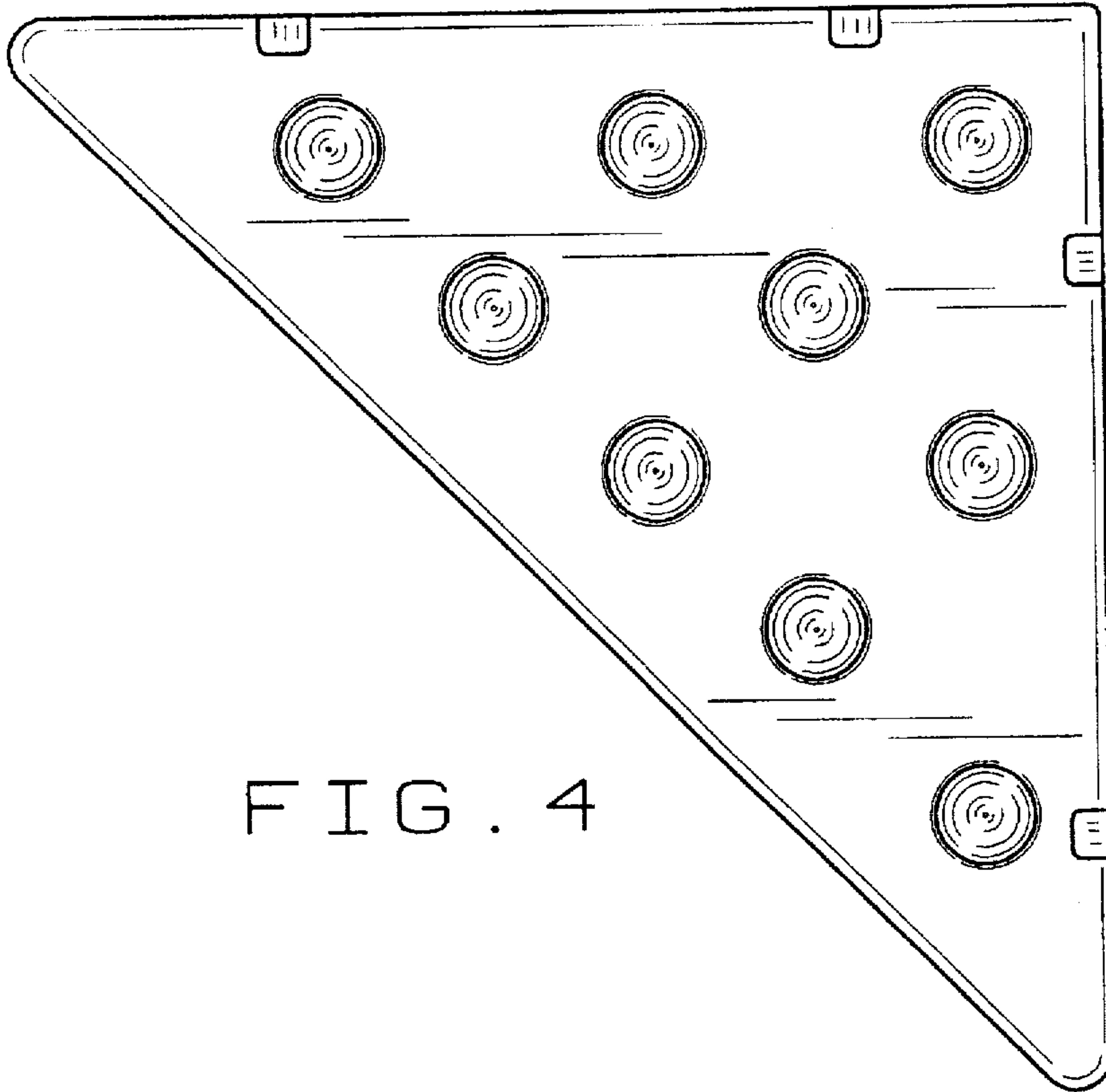

FIG. 4

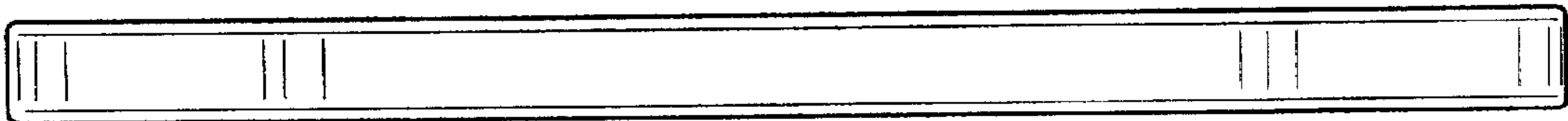

FIG. 5

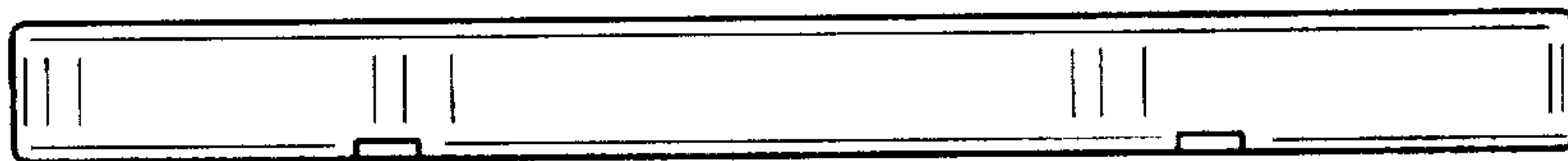

FIG. 6

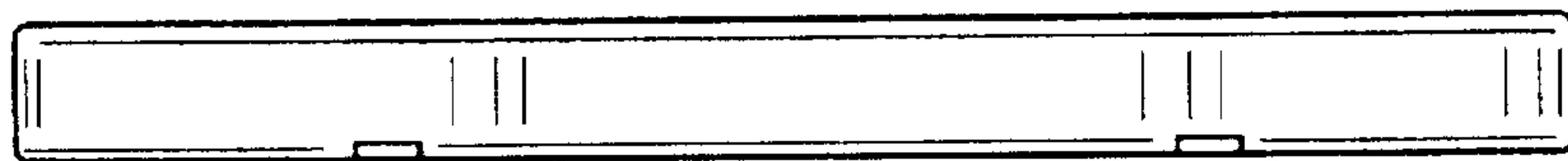

FIG. 7

UNITED STATES PATENT AND TRADEMARK OFFICE  
**CERTIFICATE OF CORRECTION**

PATENT NO. : Des 394,894

DATED : 06/02/98

INVENTOR(S) : Strawcutter et al.

It is certified that error appears in the above-identified patent and that said Letters Patent is hereby corrected as shown below:

On the Title page

Please add item [73] Assignee: --  
Soft Play, L.L.C.  
Charlotte, N. C. --.

Signed and Sealed this  
Twenty-fifth Day of May, 1999

Attest:



Q. TODD DICKINSON

Attesting Officer

Acting Commissioner of Patents and Trademarks