



US00D394885S

United States Patent [19] Chan

[11] Patent Number: **Des. 394,885**
[45] Date of Patent: ****Jun. 2, 1998**

[54] GAME CONTROL PAD

[76] Inventor: **Wah Leung Chan**, Flat L, Block 4,
12/F, Kwun Tong Ind. Bldg., 436-446
Kwun Tong Rd., Kowloon, Hong Kong

[**] Term: **14 Years**

[21] Appl. No.: **67,305**

[22] Filed: **Mar. 3, 1997**

[30] Foreign Application Priority Data

Sep. 6, 1996 [GB] United Kingdom 2059148

[51] LOC (6) Cl. **21-01**

[52] U.S. Cl. **D21/48**

[58] Field of Search D21/1, 13, 48;
273/148 B; 463/1, 30-47; D14/114, 217

[56] References Cited

U.S. PATENT DOCUMENTS

- D. 363,320 10/1995 Barthelemy et al. D21/48
- D. 375,326 11/1996 Yokoi et al. D21/48
- D. 376,826 12/1996 Ashida D21/48
- D. 377,198 1/1997 Oikawa et al. D21/48

- D. 380,783 7/1997 Tyler D21/48
- 5,184,830 2/1993 Okada et al. 463/46 X
- 5,207,426 5/1993 Inoue et al. 463/46

OTHER PUBLICATIONS

Game Players, Jan. 1996, p. 36.

Primary Examiner—Prabhakar G. Deshmukh
Attorney, Agent, or Firm—Samuels, Gauthier, Stevens & Reppert

[57] CLAIM

The ornamental design for a game control pad, as shown.

DESCRIPTION

FIG. 1 is a perspective view of a game control pad showing my new design;
FIG. 2 is a front elevational view thereof;
FIG. 3 is a rear elevational view thereof;
FIG. 4 is a right side view thereof;
FIG. 5 is a left side view thereof;
FIG. 6 is a top plan view thereof; and,
FIG. 7 is a bottom plan view thereof.

1 Claim, 4 Drawing Sheets

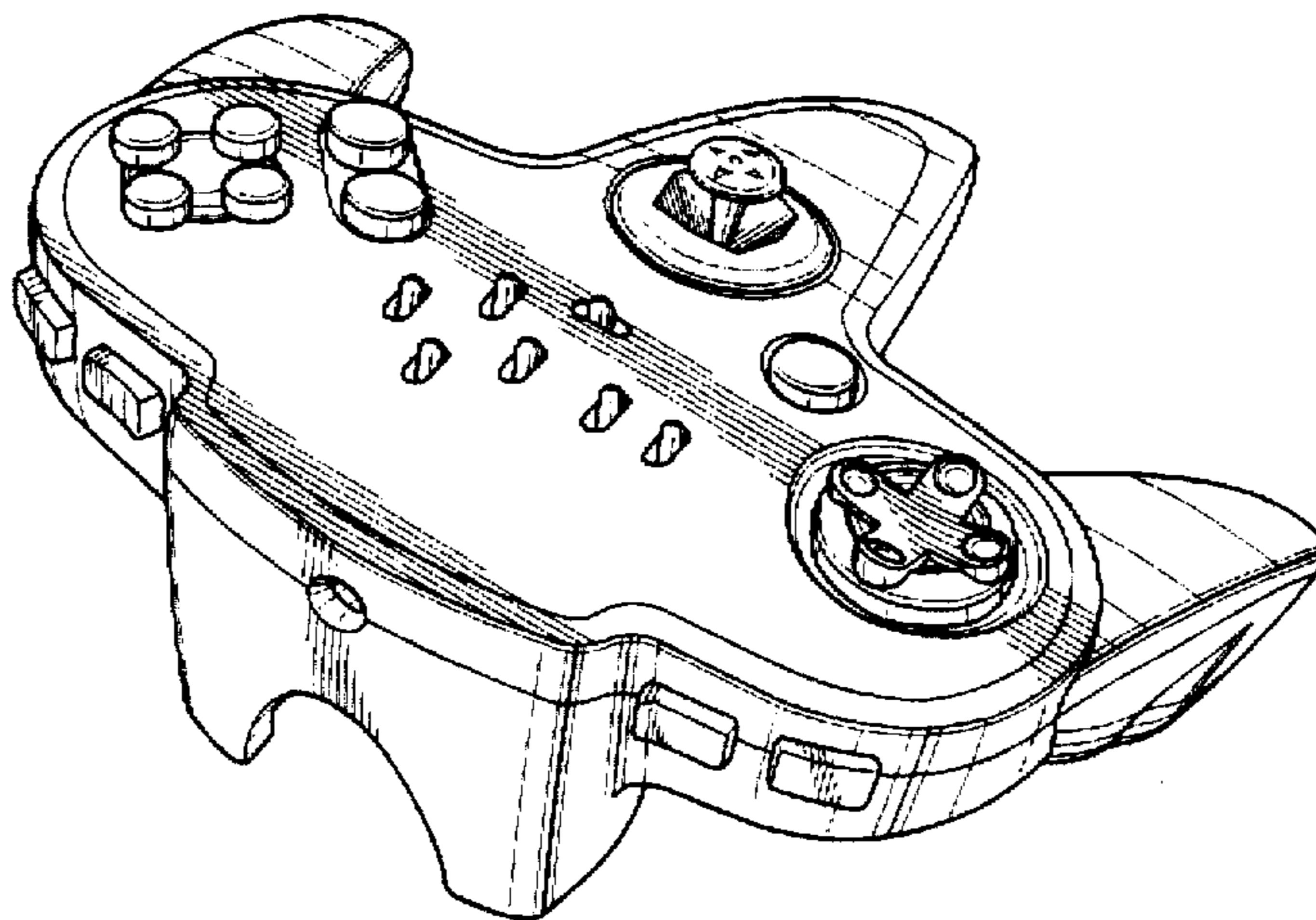

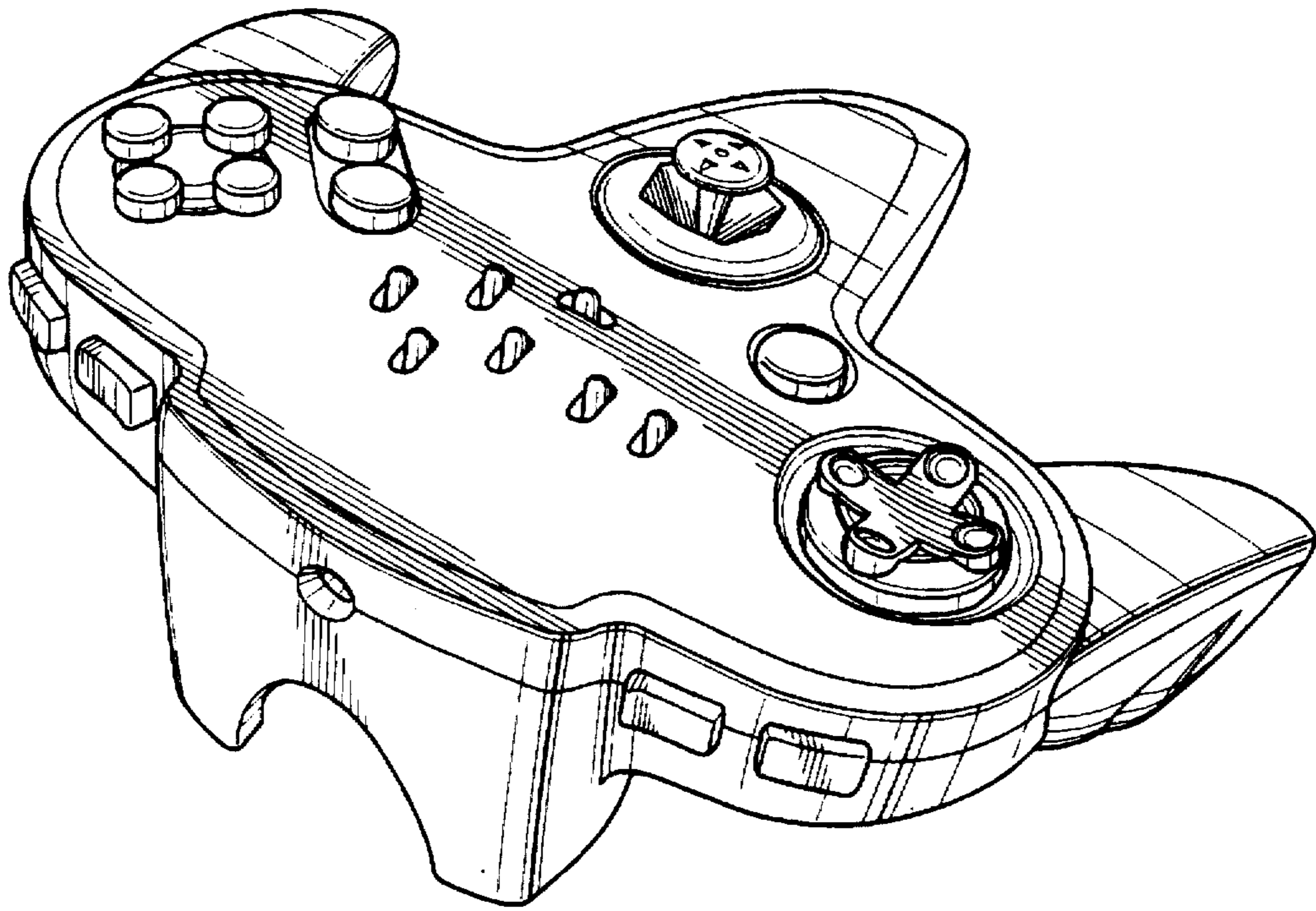

FIG. 1

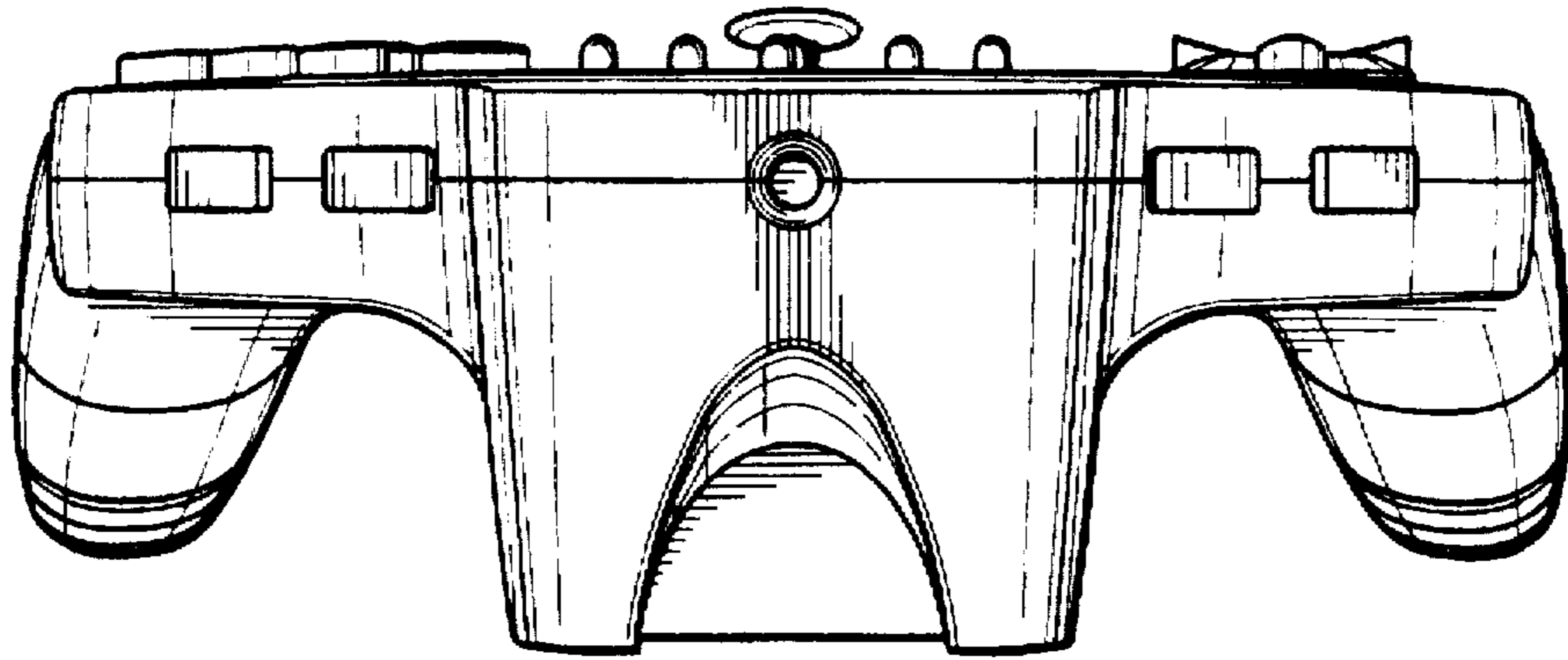

FIG. 2

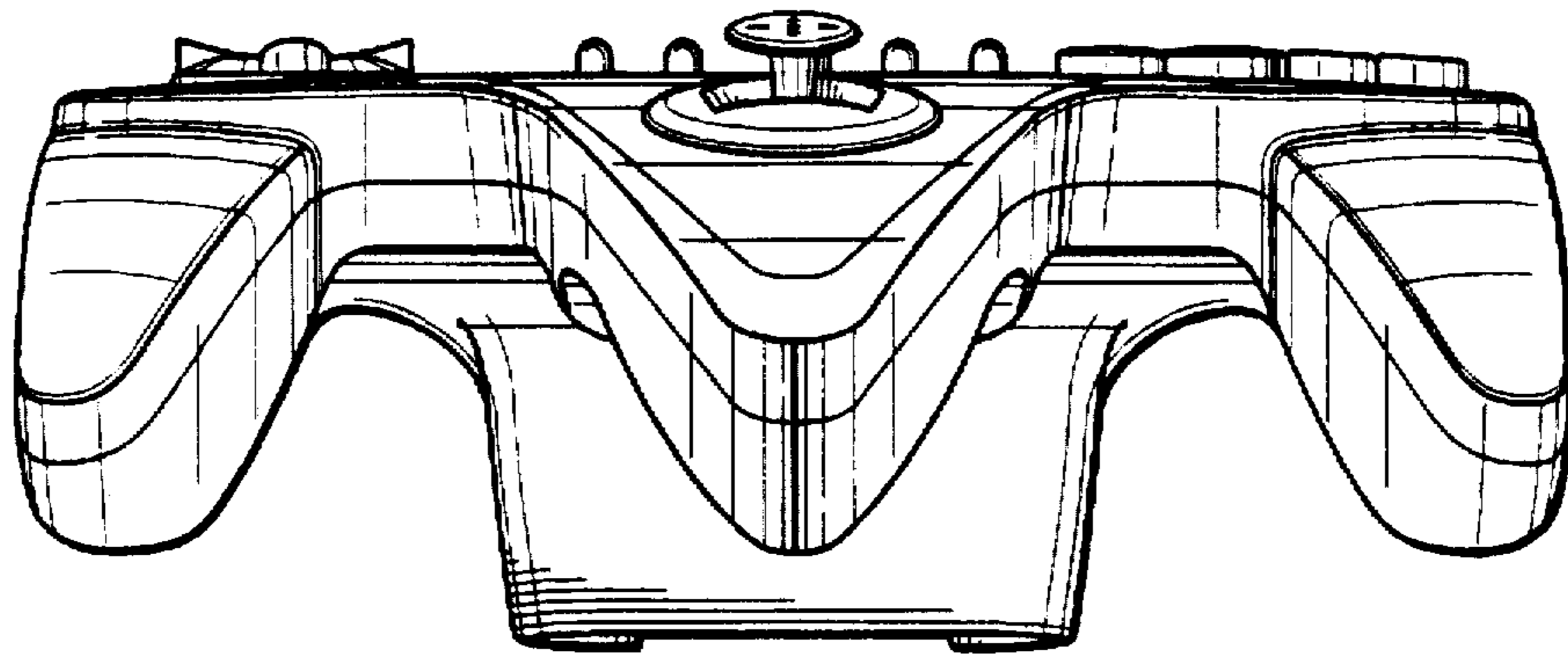

FIG. 3

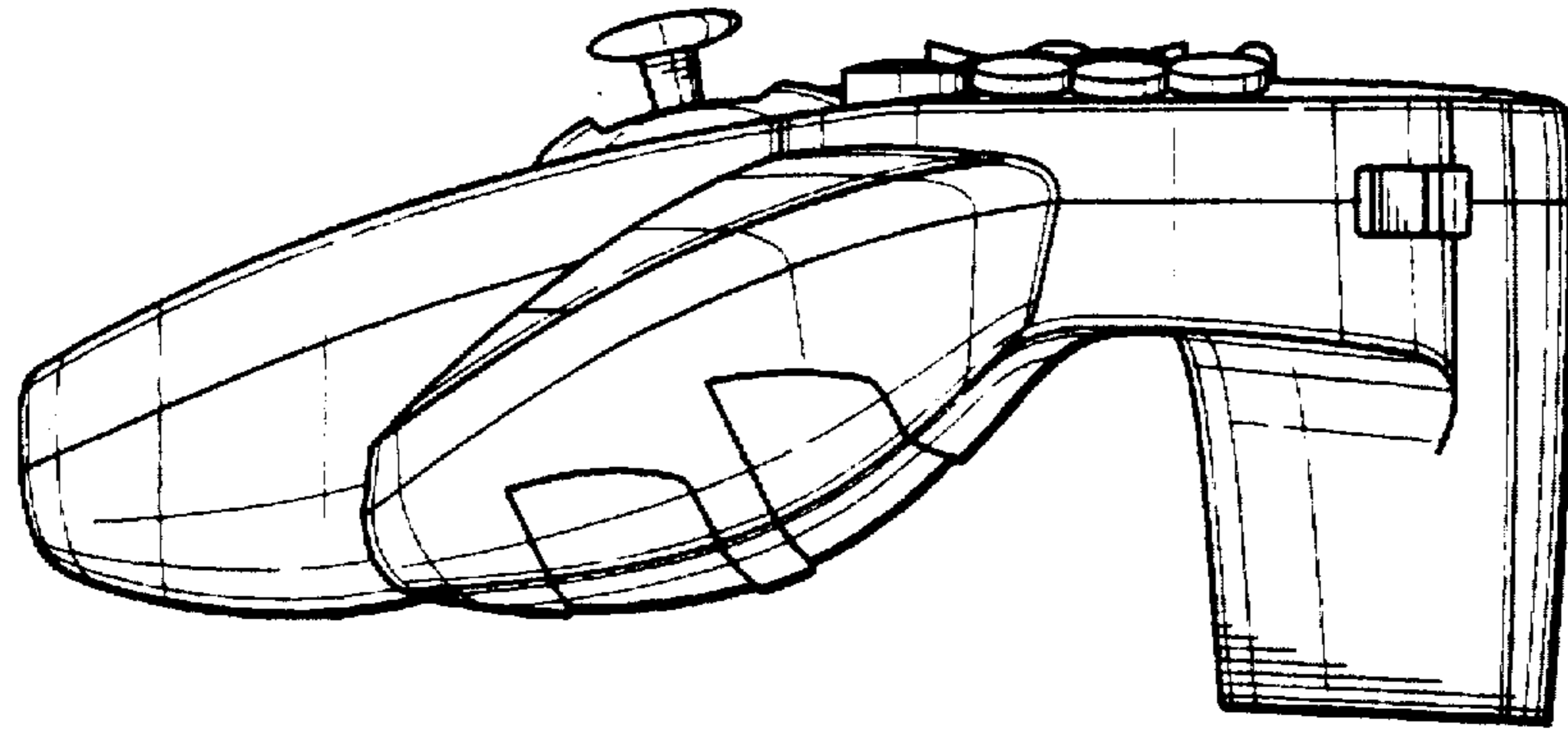

FIG. 4

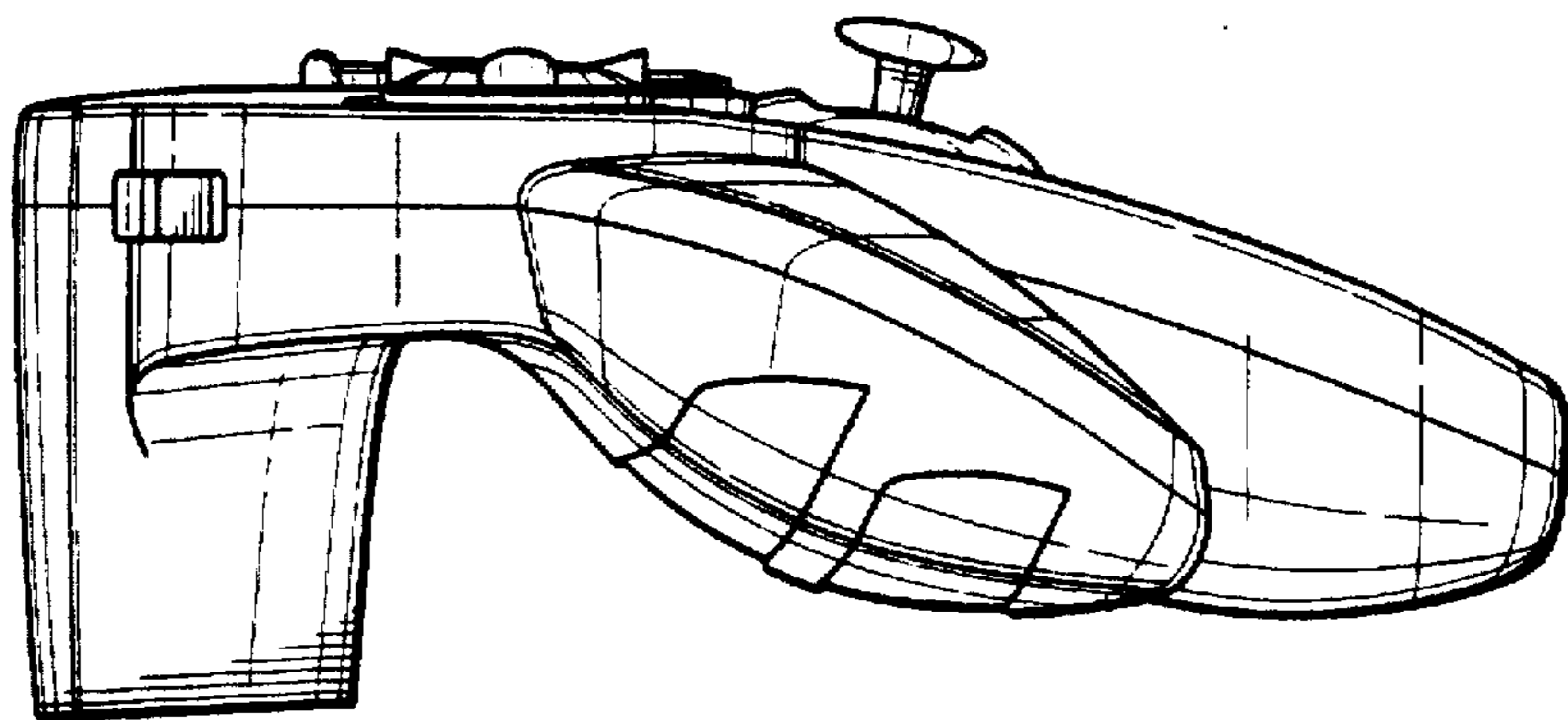

FIG. 5

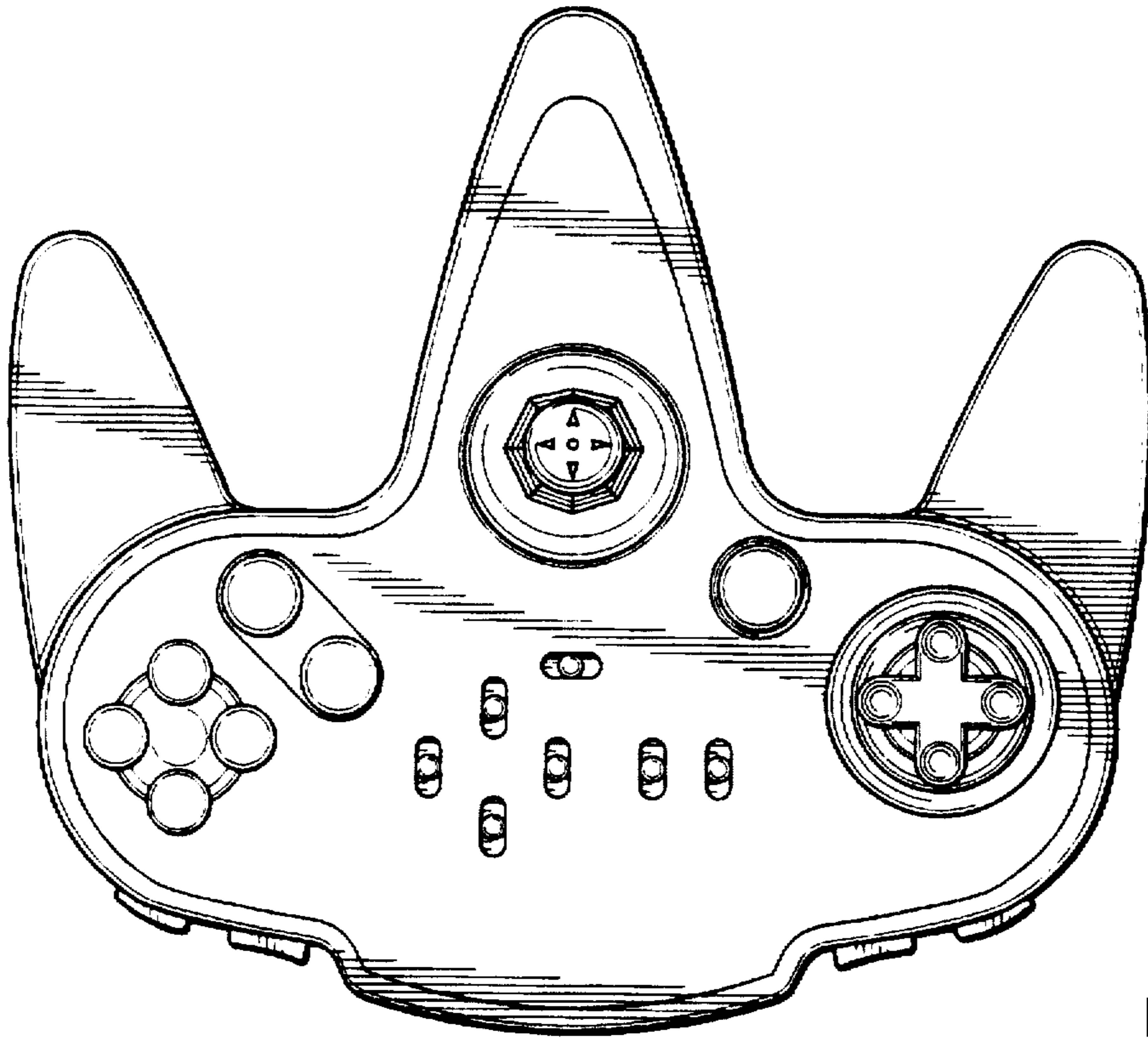

FIG. 6

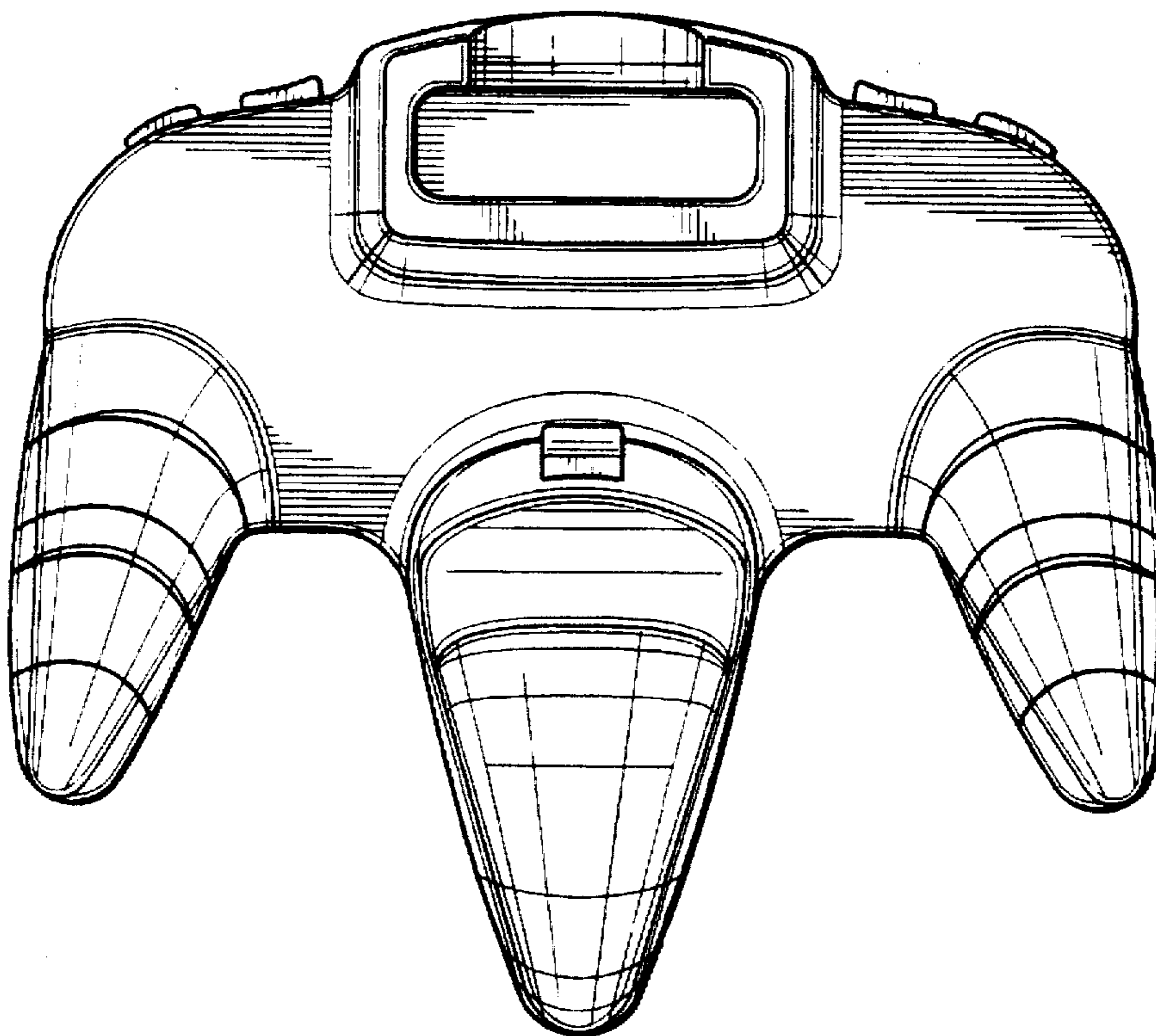

FIG. 7