



US00D394828S

United States Patent [19]
Ray

[11] **Patent Number: Des. 394,828**
[45] **Date of Patent: **Jun. 2, 1998**

[54] **HOLDER FOR FLORAL ARRANGEMENTS**

[75] Inventor: **James E. Ray**, Brantford, Canada

[73] Assignee: **Ray's Flowers Limited**, Brantford, Canada

[**] Term: **14 Years**

[21] Appl. No.: **71,797**

[22] Filed: **Jun. 9, 1997**

[51] **LOC (6) Cl.** **11-02**

[52] **U.S. Cl.** **D11/164; D11/155**

[58] **Field of Search** **D11/143, 144, D11/152-156, 164; D6/403; 47/65.5, 66.7, 71, 39, 40, 41.01, 44; 206/423, 557, 564; 248/27.8**

[56] **References Cited**

U.S. PATENT DOCUMENTS

D. 250,402 11/1978 Connell et al. D11/156

D. 272,329 1/1984 Clemmons, Jr. D11/147

Primary Examiner—Caron D. Veynar
Attorney, Agent, or Firm—R. Craig Armstrong

[57] **CLAIM**

The ornamental design for holder for floral arrangements, as shown.

DESCRIPTION

FIG. 1 is a perspective view of the holder for floral arrangements, from above and behind;
FIG. 2 is a plan view of the holder for floral arrangements;
FIG. 3 is a front view of the holder for floral arrangements;
FIG. 4 is rear view of the holder for floral arrangements;
FIG. 5 is bottom view of the holder for floral arrangements;
FIG. 6 is a left side view of the holder for floral arrangements; and,
FIG. 7 is a right side view of the holder for floral arrangements.

1 Claim, 4 Drawing Sheets

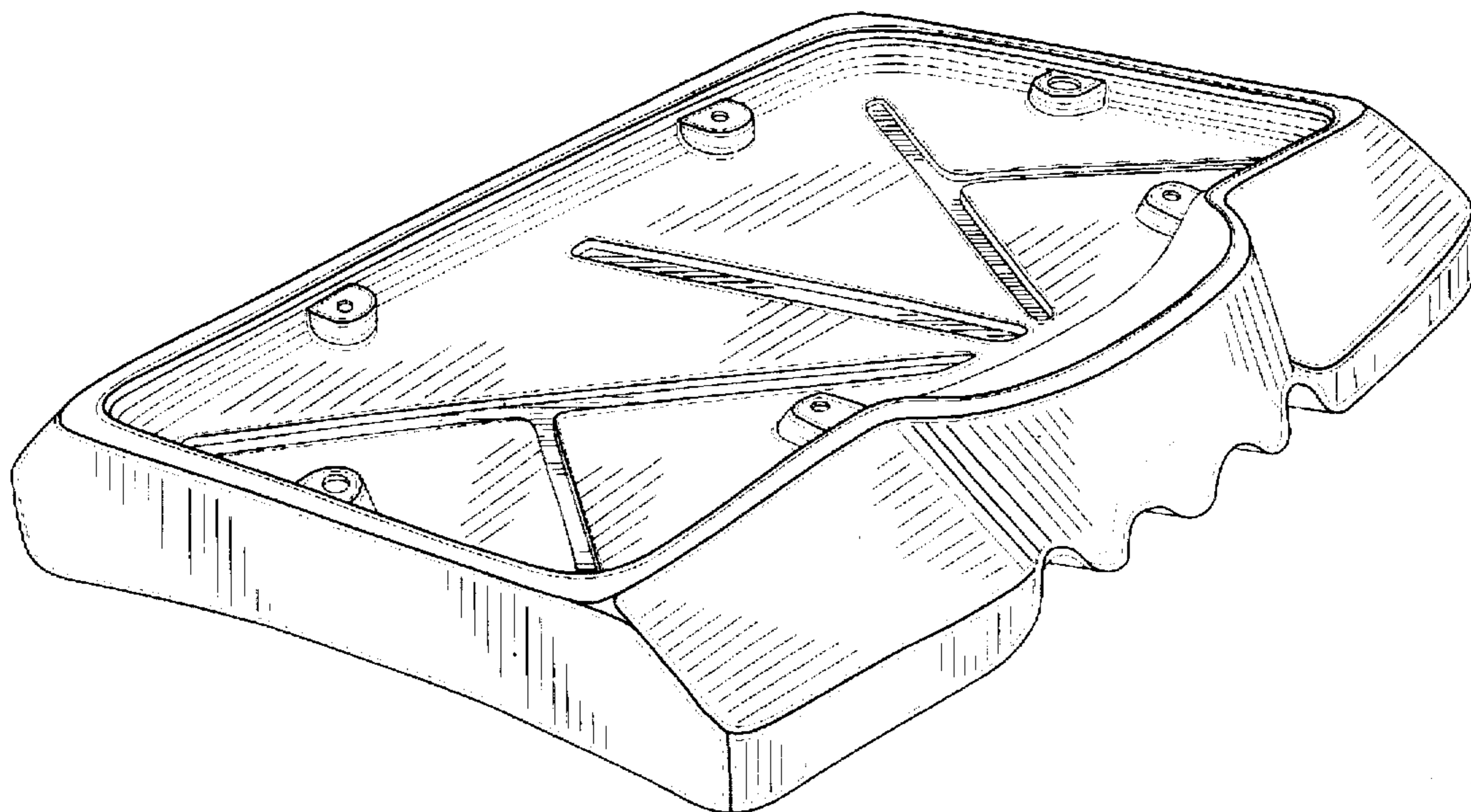

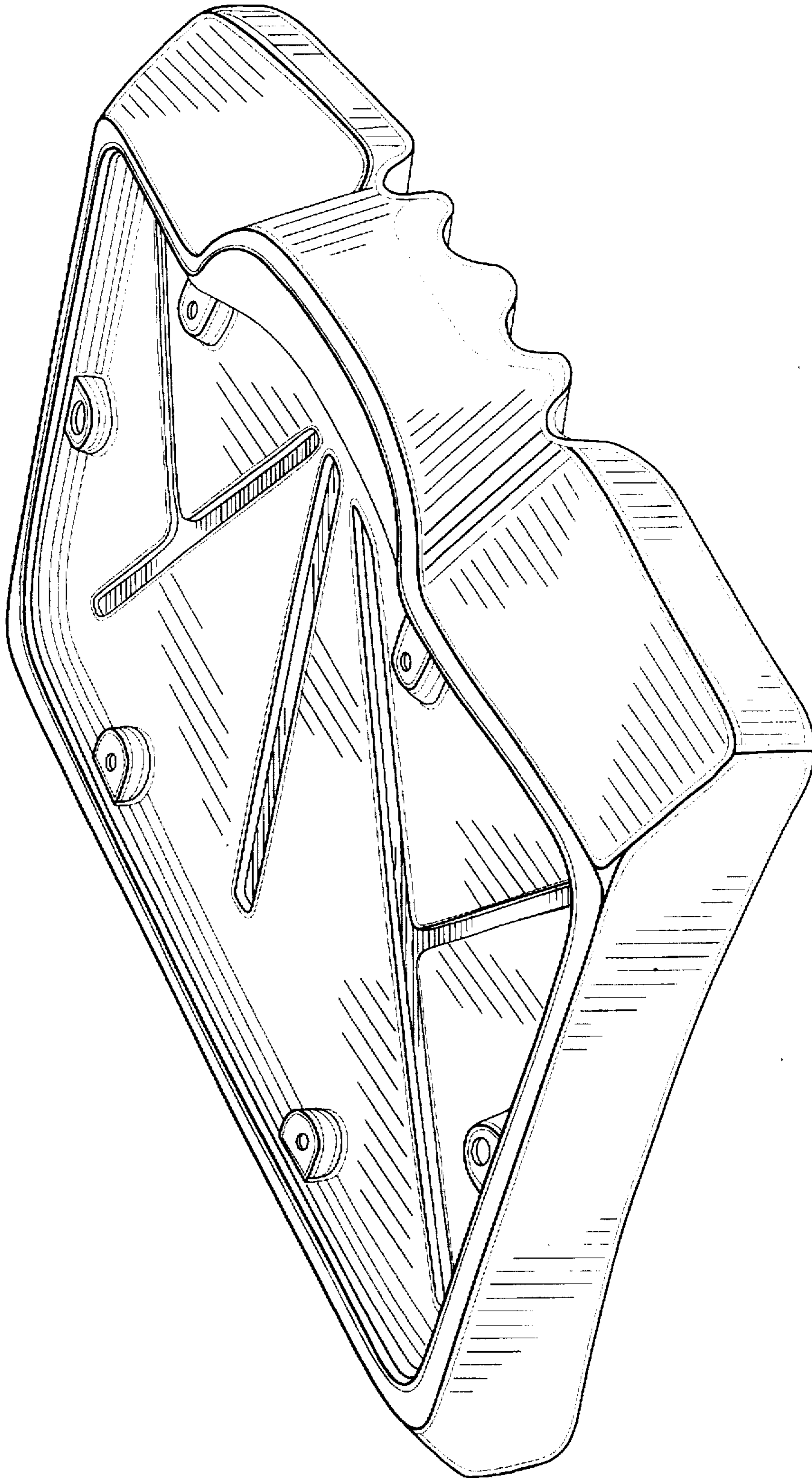

FIG. 1

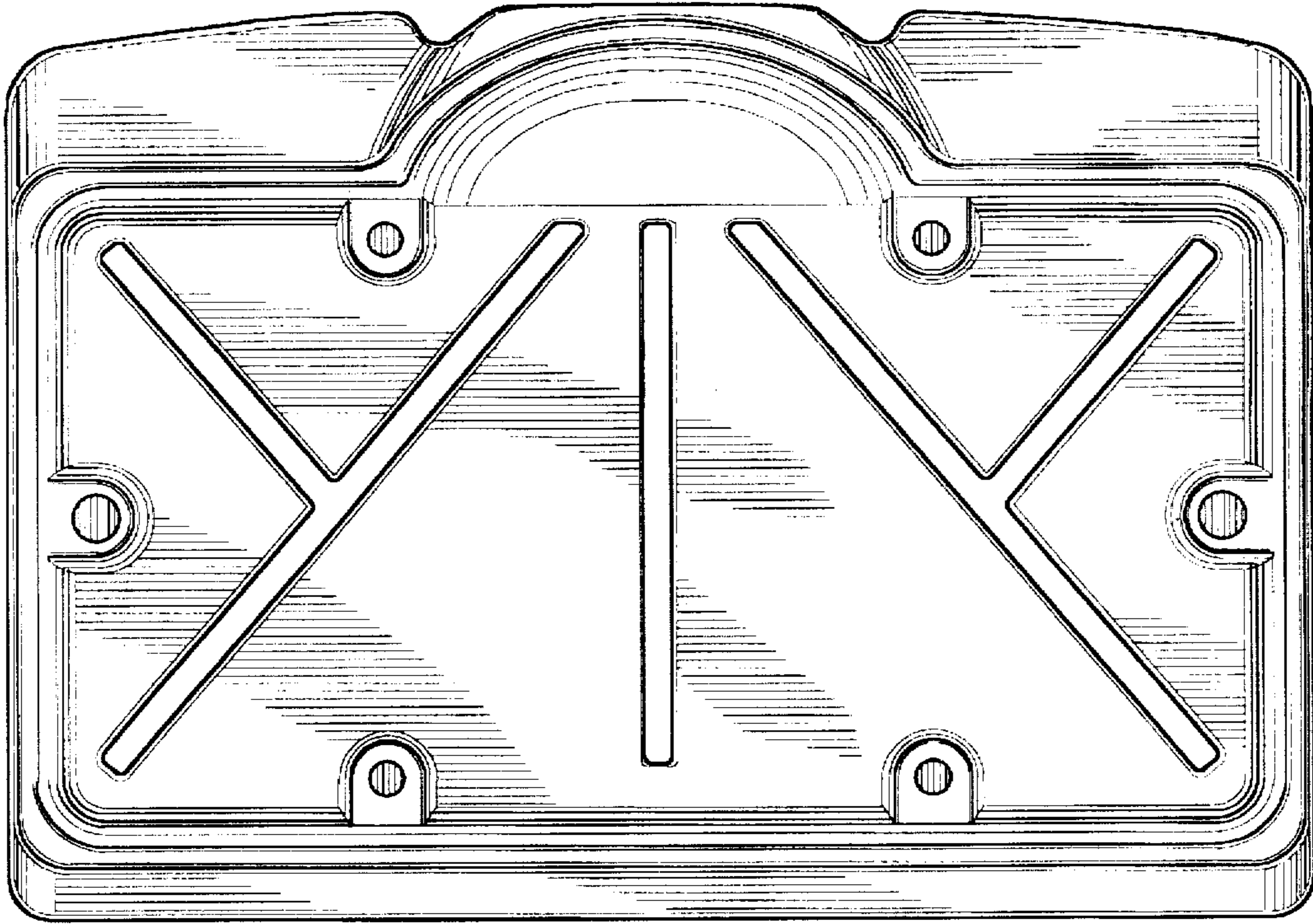

FIG. 2

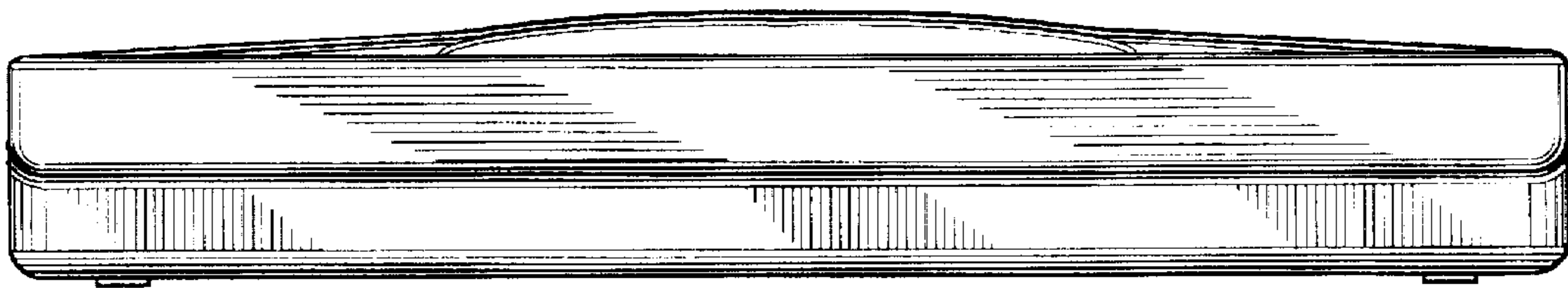

FIG. 3

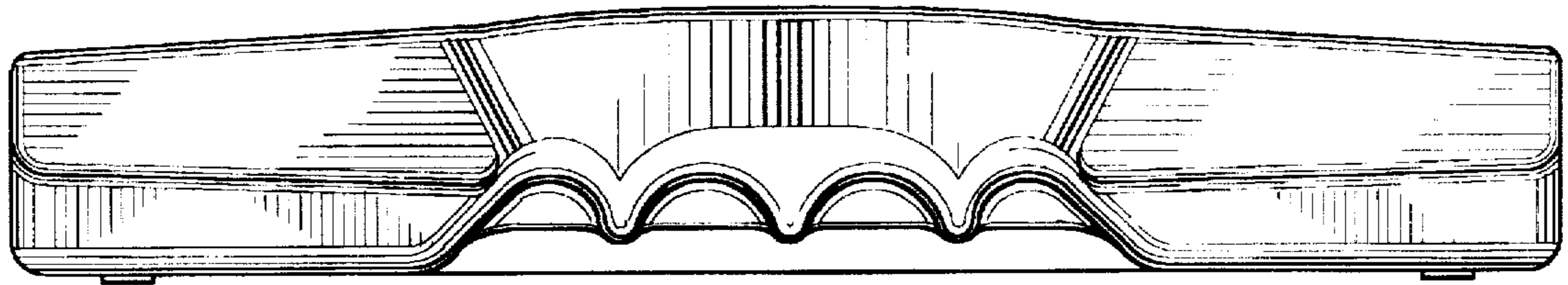

FIG. 4

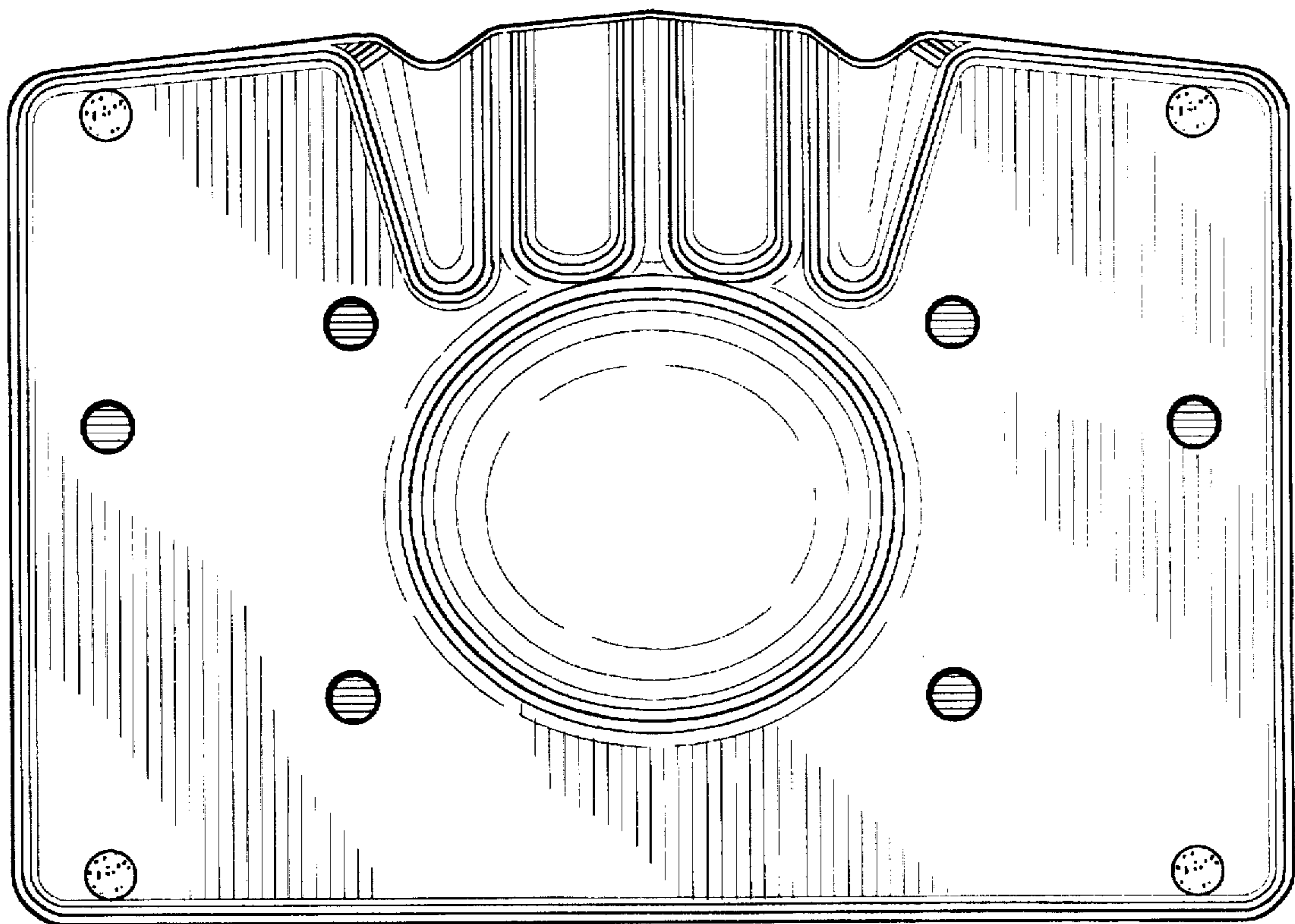

FIG. 5

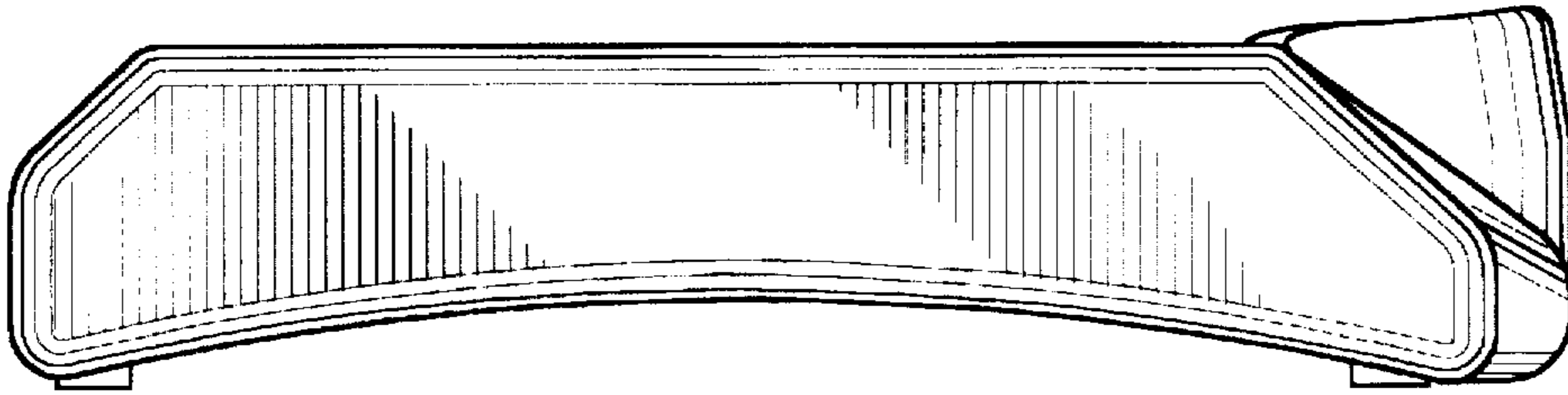

FIG. 6

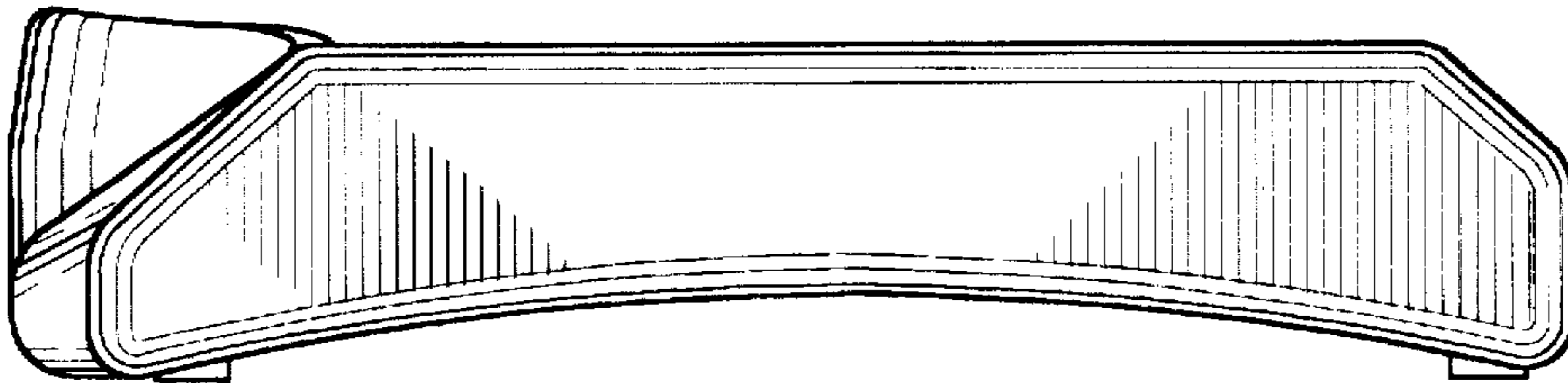

FIG. 7