

US00D394647S

**United States Patent** [19]  
**Kong**

[11] **Patent Number: Des. 394,647**  
[45] **Date of Patent: \*\*May 26, 1998**

[54] **FRONT PANEL FOR COMPUTER CASE**

[75] **Inventor: Wei Kong, Taipei, Taiwan**

[73] **Assignee: Superpower Supply, Inc., Santa Fe Springs, Calif.**

[\*\*] **Term: 14 Years**

[21] **Appl. No.: 70,575**

[22] **Filed: May 12, 1997**

[51] **LOC (6) Cl. .... 14-02**

[52] **U.S. Cl. .... D14/115**

[58] **Field of Search** ..... D14/100, 102,  
D14/107-109; D13/162, 184, 199; D6/432,  
436, 445, 448; 312/254, 292; 360/97.01,  
97.04, 98.01, 99.01, 99.12; 361/683, 694,  
696

[56] **References Cited**

**U.S. PATENT DOCUMENTS**

D. 374,439 10/1996 Paterson et al. .... D14/115

*Primary Examiner—Freda Nunn*  
*Attorney, Agent, or Firm—Raymond Sun*

[57] **CLAIM**

The ornamental design for a front panel for computer case, as shown and described.

**DESCRIPTION**

FIG. 1 is a perspective view of my front panel for computer case;

FIG. 2 is a front view of the front panel of FIG. 1;

FIG. 3 is a rear view of the front panel of FIG. 1;

FIG. 4 is a left side elevational view of the front panel of FIG. 1;

FIG. 5 is a right side elevational view of the front panel of FIG. 1;

FIG. 6 is a top plan view of the front panel of FIG. 1; and, FIG. 7 is a bottom plan view of the front panel of FIG. 1.

**1 Claim, 4 Drawing Sheets**

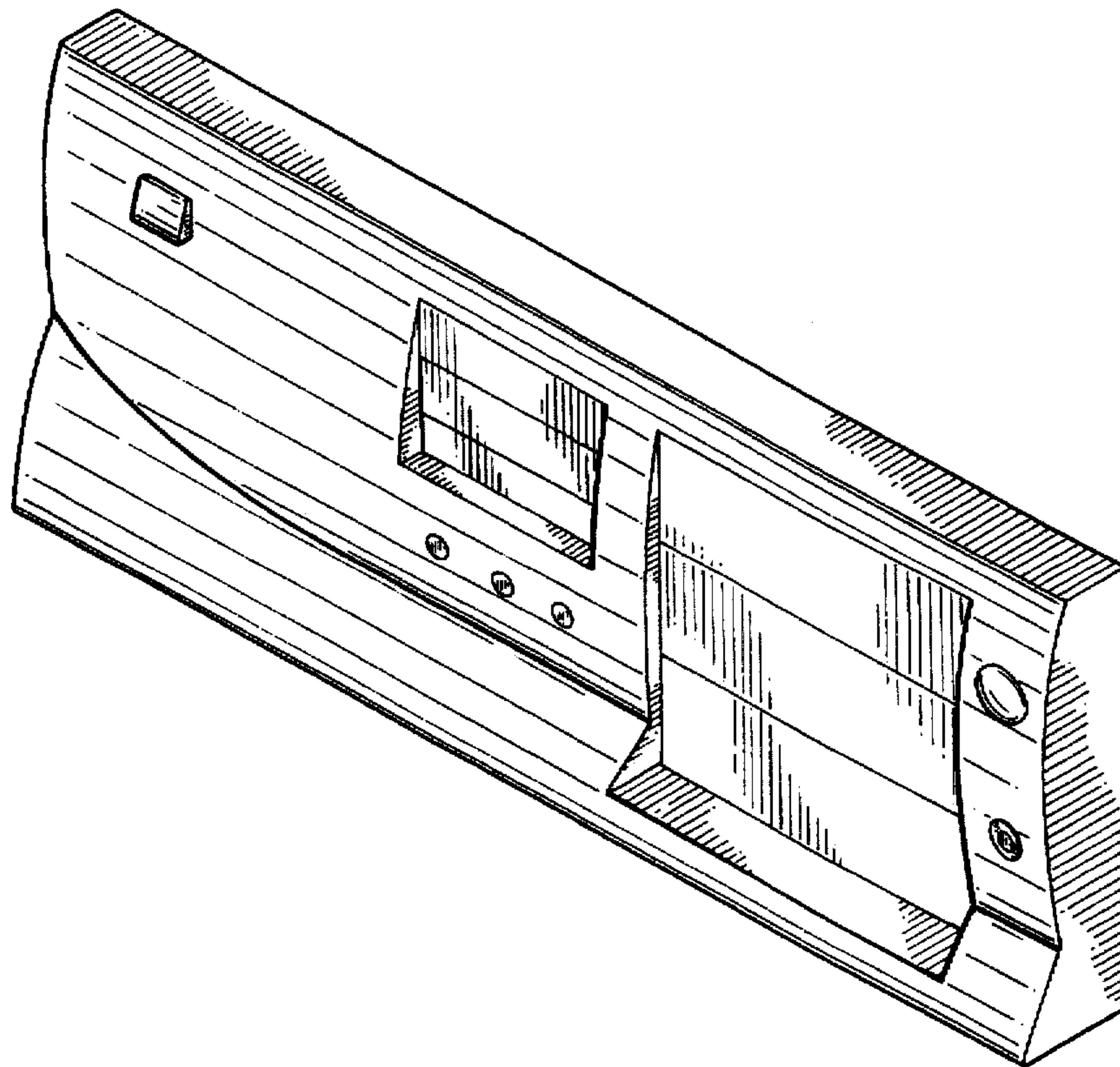

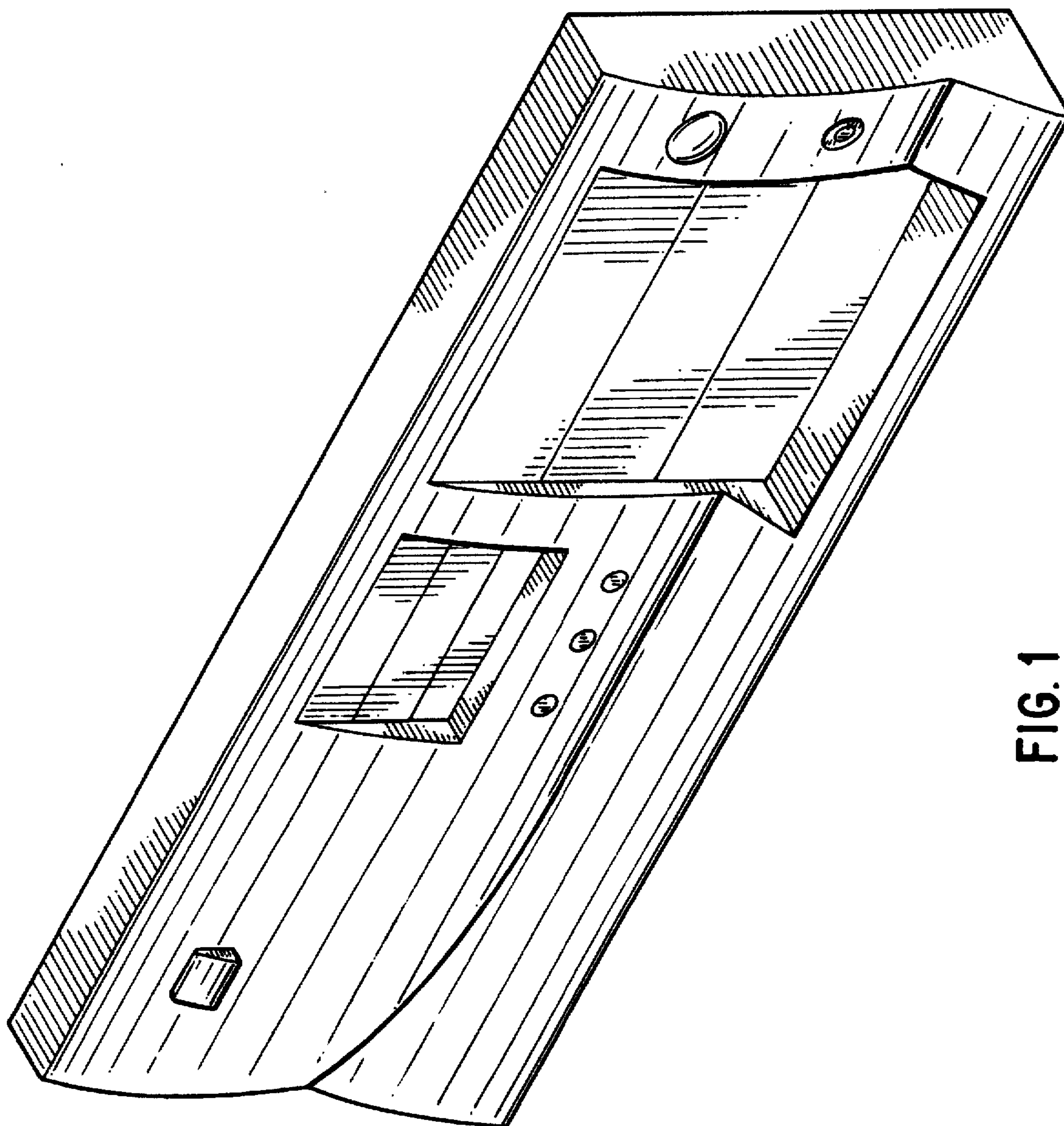

FIG. 1

FIG. 2

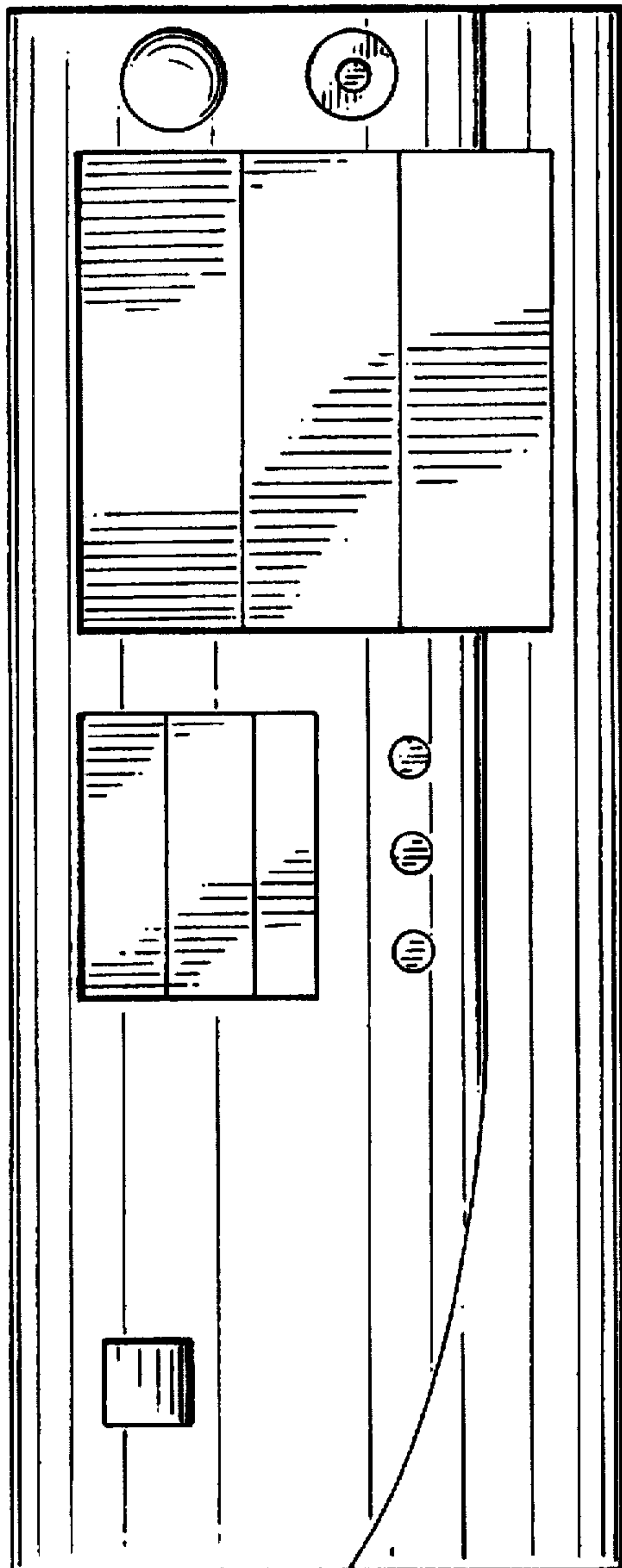
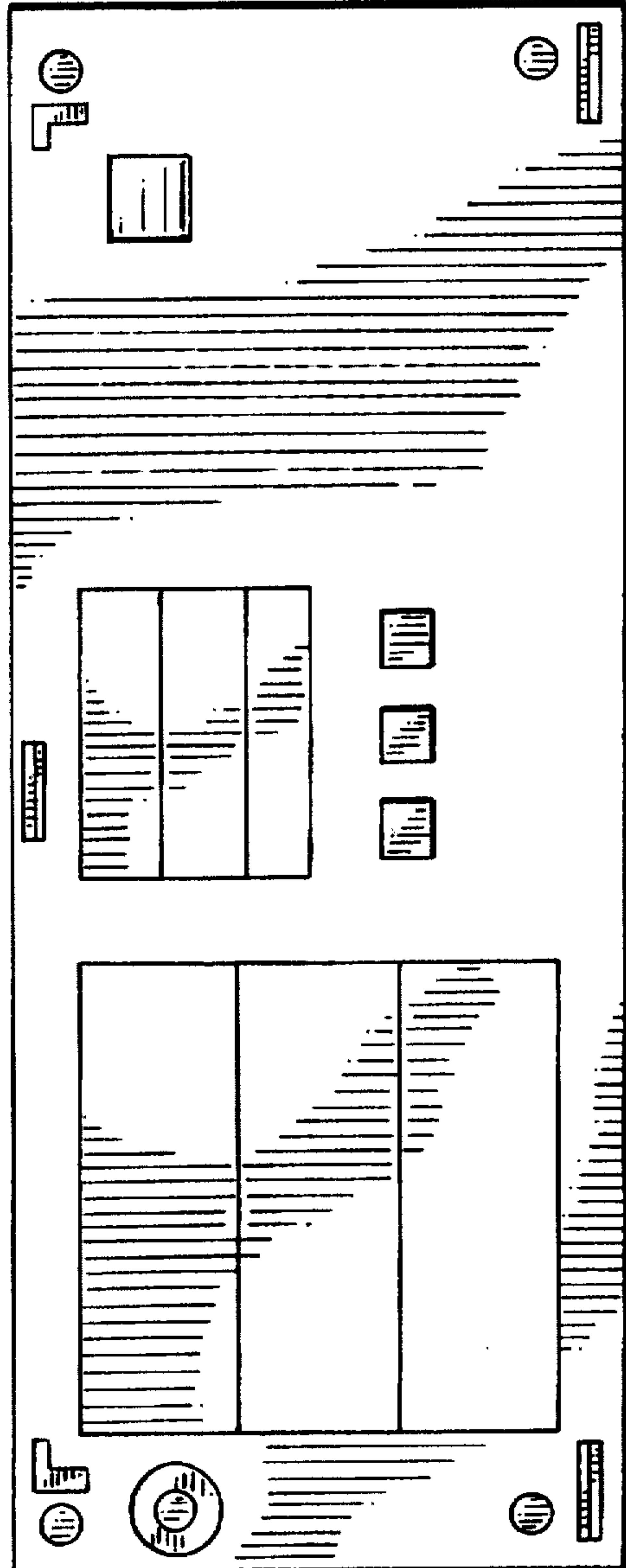

FIG. 3



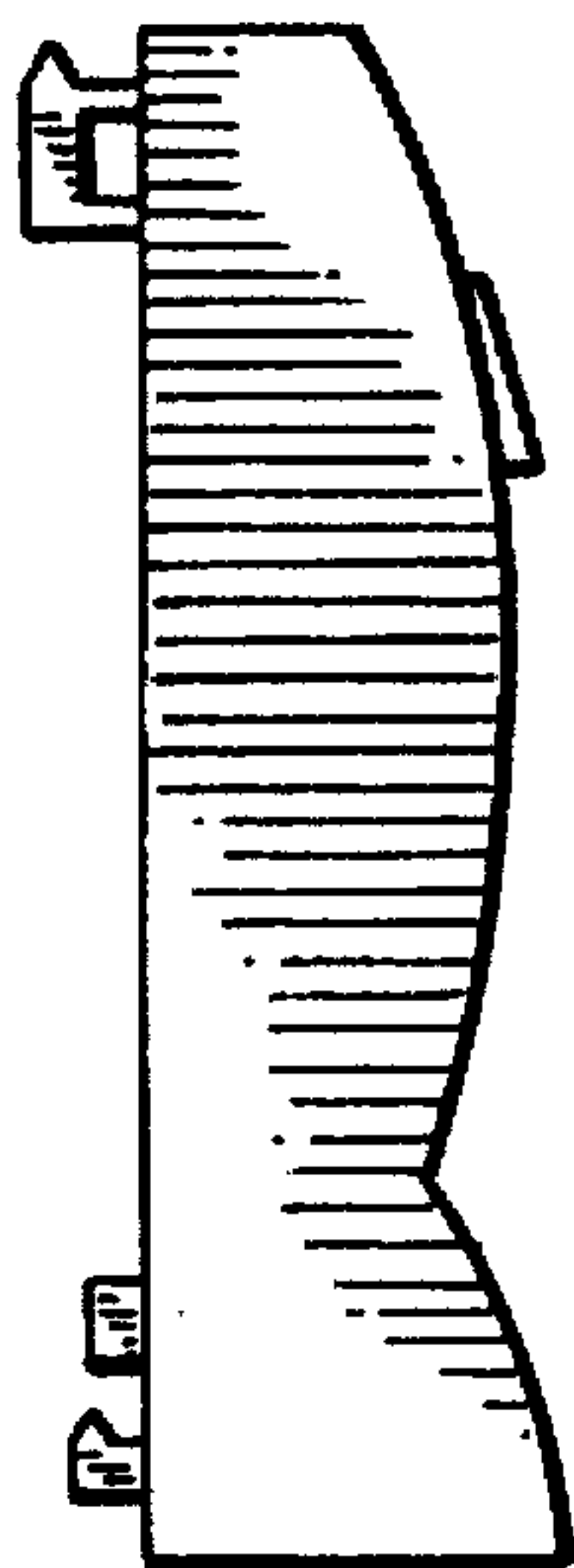

FIG. 4

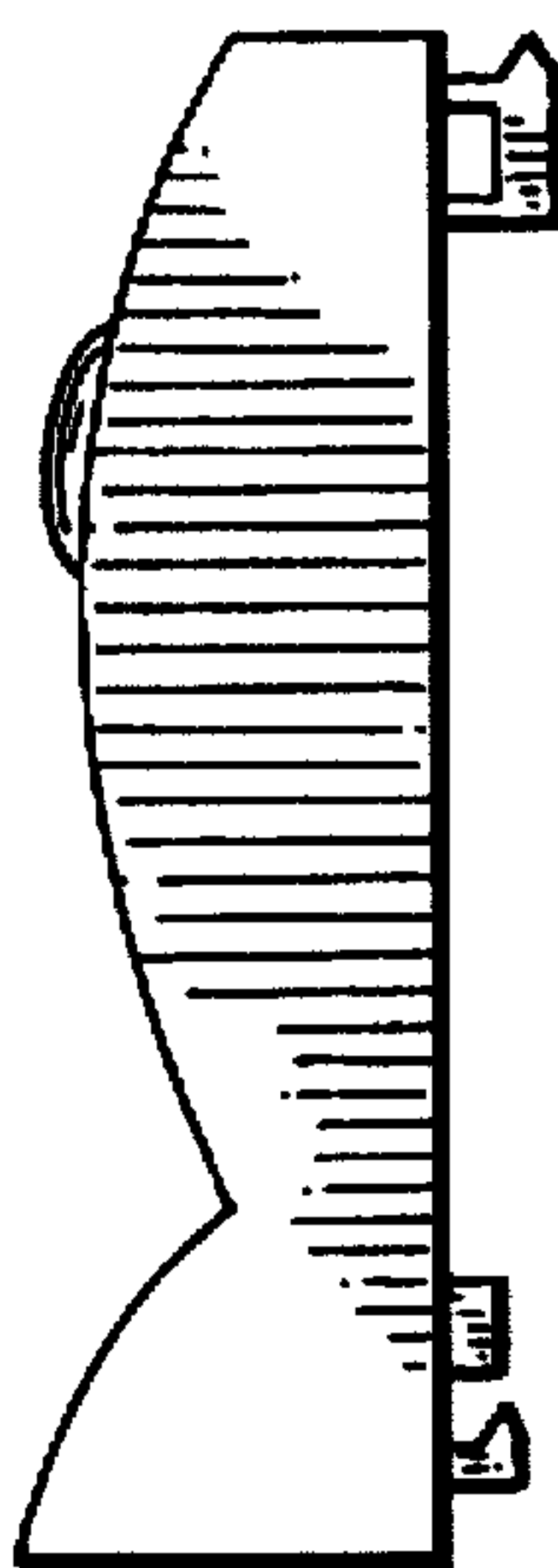

FIG. 5

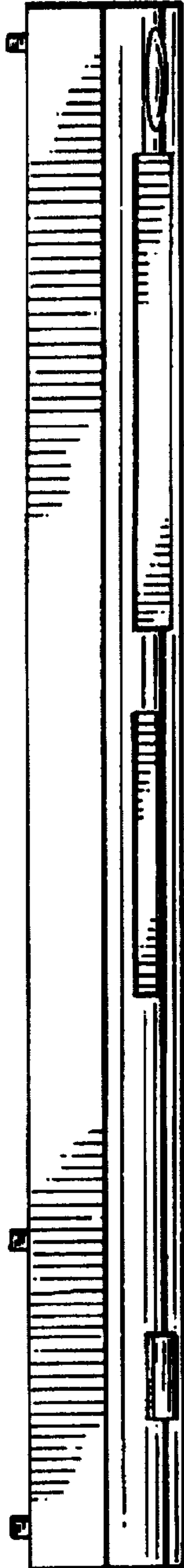

FIG. 6

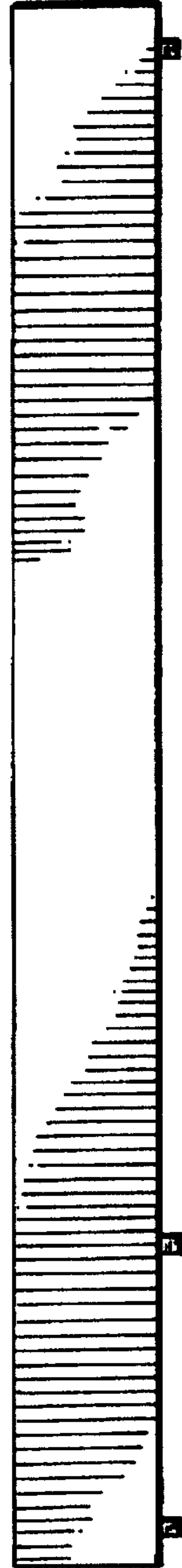

FIG. 7