



US00D394639S

United States Patent [19]

[11] **Patent Number: Des. 394,639**

Carter

[45] **Date of Patent: **May 26, 1998**

[54] **VEHICLE SPORT UTILITY RACK**

[57] **CLAIM**

[76] **Inventor: Randy Carter, P.O. Box 43650,
Phoenix, Ariz. 85080**

The ornamental design for a vehicle sport utility rack, as shown and described.

[**] **Term: 14 Years**

DESCRIPTION

[21] **Appl. No.: 55,142**

FIG. 1 is a perspective view of a vehicle sport utility rack showing my new design where the rack is shown positioned and secured to the bed of a pickup truck. The broken line showing of the pickup truck is for illustrative purposes only and forms no part of the claimed design;

[22] **Filed: May 30, 1996**

FIG. 2 is an enlarged top plan view of the vehicle sport utility rack of FIG. 1;

[51] **LOC (6) Cl. 12-16**

[52] **U.S. Cl. D12/406**

[58] **Field of Search D12/400, 406,
D12/412-414; 296/37.1, 3**

FIG. 3 is a side elevational view of FIG. 2;

FIG. 4 is a front elevational view of FIG. 2;

FIG. 5 is a rear elevational view of FIG. 2;

FIG. 6 is a bottom plan view of FIG. 2;

FIG. 7 is a perspective view of the vehicle sport utility rack showing the three vertical braces equally spaced apart positioned and secured to the bed of a pickup truck. The broken line showing of the pickup truck is for illustrative purposes only and forms no part of the claimed design; and,

FIG. 8 is a perspective view of the vehicle sport utility rack showing the three vertical braces positioned adjacent to one another positioned and secured to the bed of a pickup truck. The broken line showing of the pickup truck is for illustrative purposes only and forms no part of the claimed design.

[56] **References Cited**

U.S. PATENT DOCUMENTS

D. 363,460	10/1995	Marshall	D12/406
5,037,152	8/1991	Hendricks	296/3
5,137,320	8/1992	Christensen	296/3
5,143,415	9/1992	Boudah	296/3
5,238,280	8/1993	Christensen	296/3
5,431,472	7/1995	Coffland	296/3
5,494,327	2/1996	Derecktor	296/3
5,513,890	5/1996	Christensen	296/3
5,560,666	10/1996	Vieira et al.	296/3

Primary Examiner—James Gandy
Assistant Examiner—Stacia Sinuik
Attorney, Agent, or Firm—Snell & Wilmer, L.L.P.

1 Claim, 2 Drawing Sheets

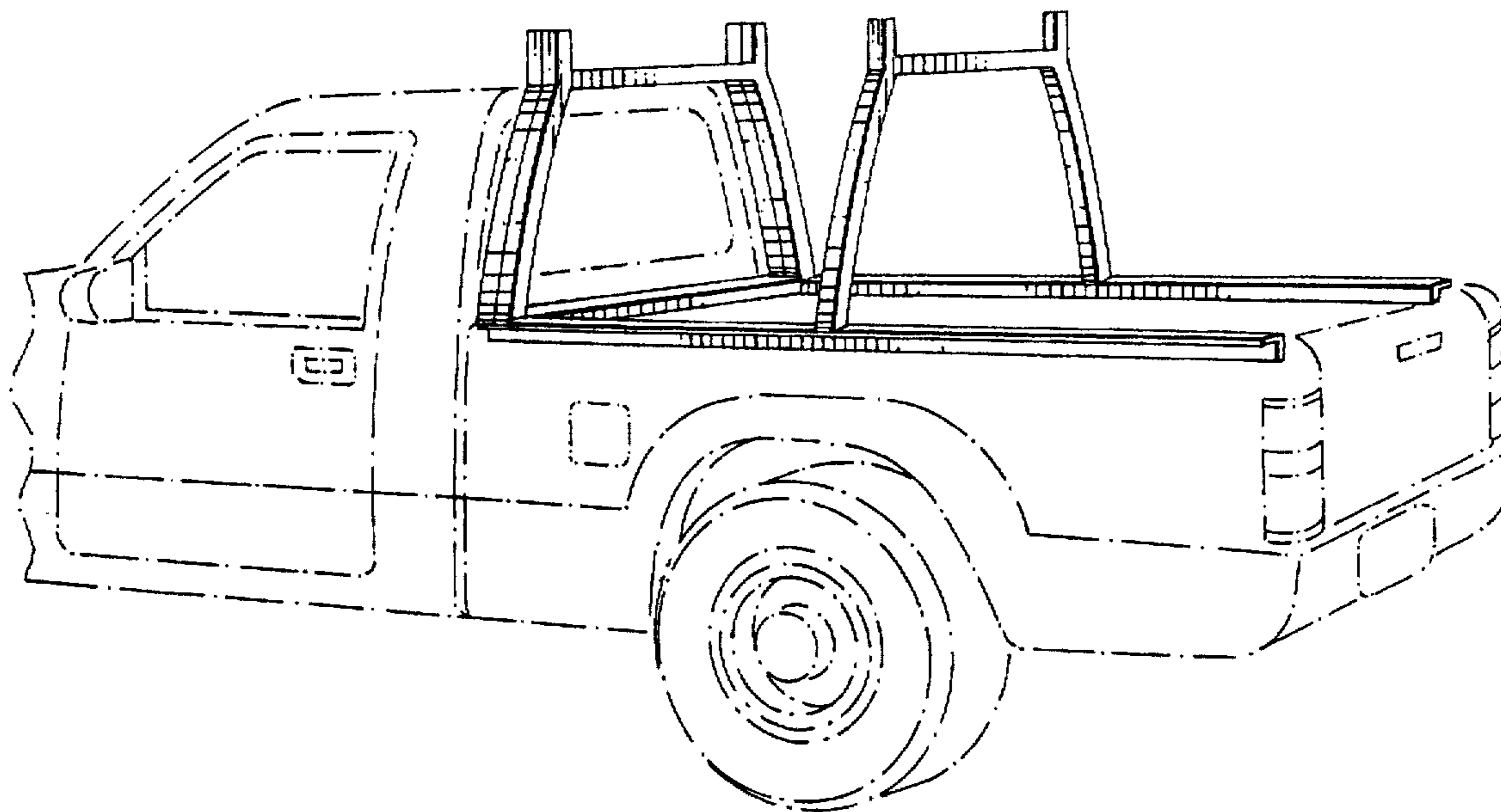

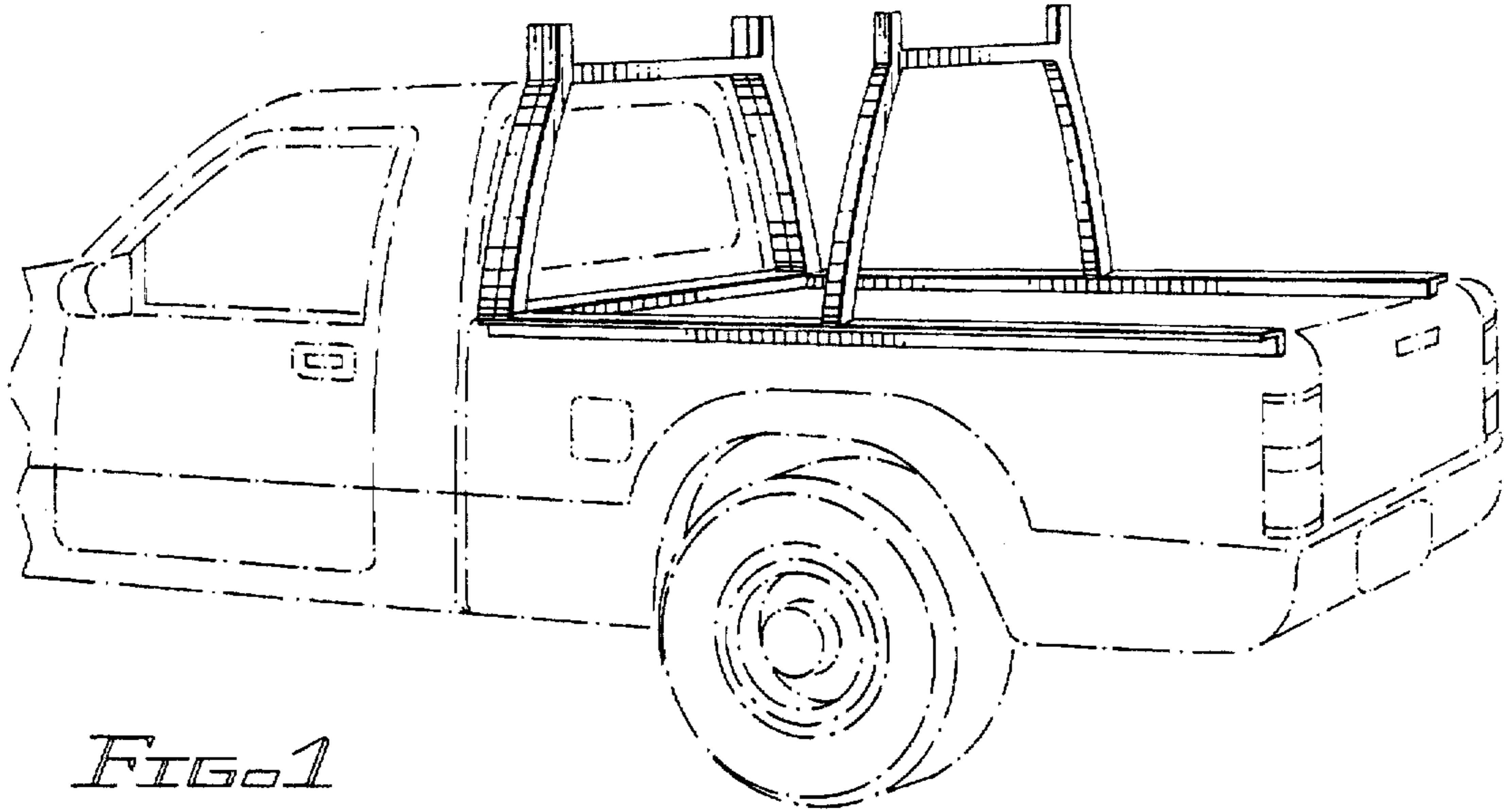

FIG. 1

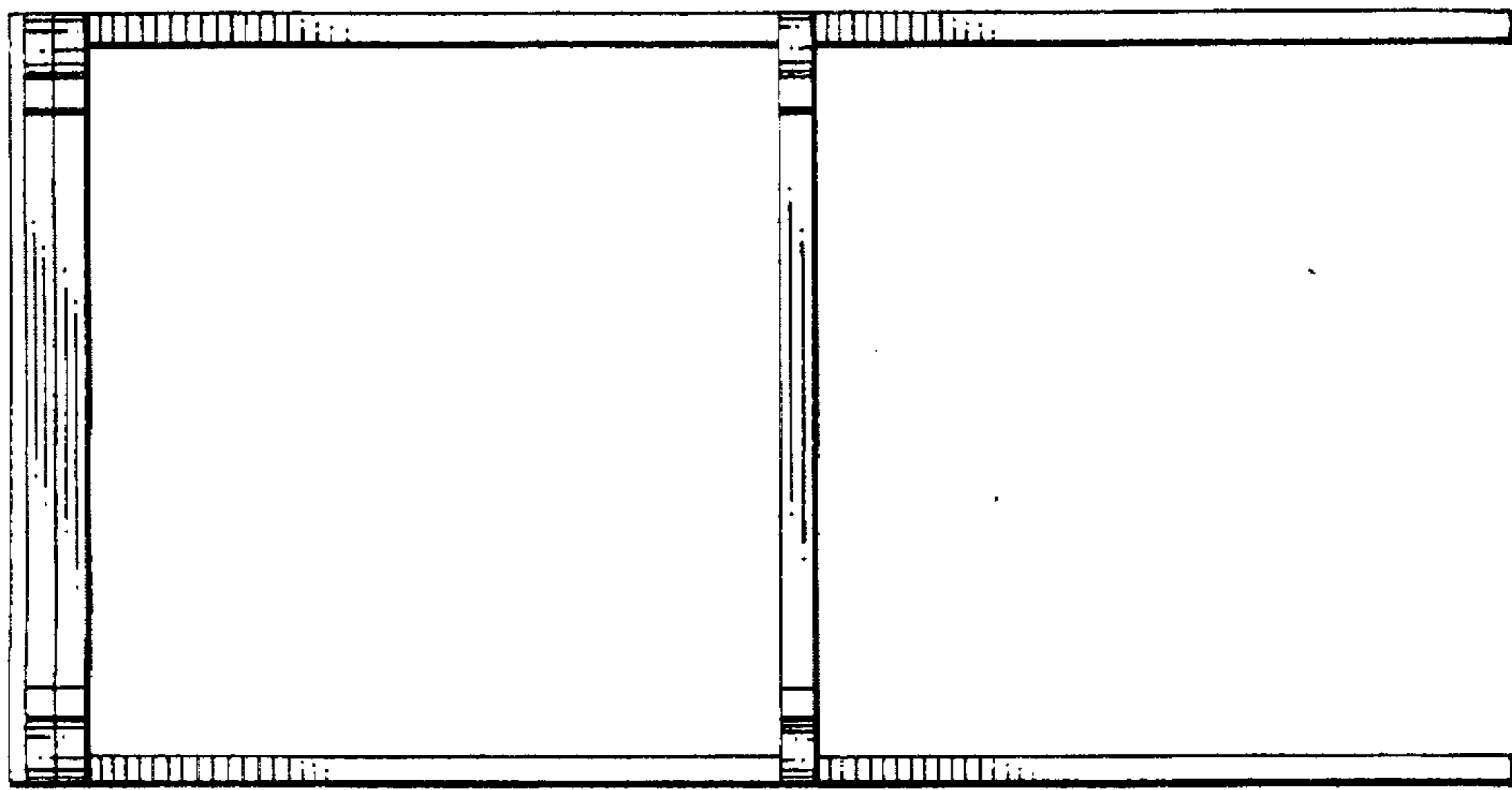

FIG. 2

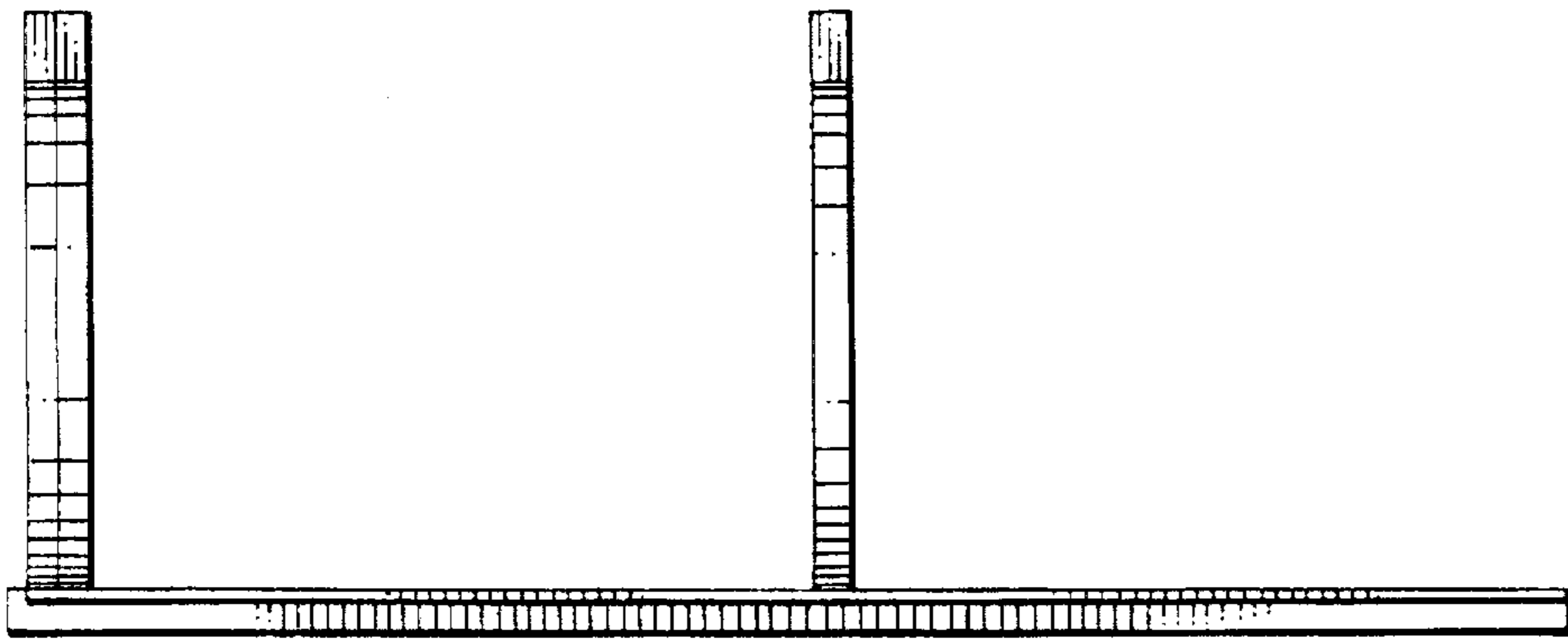

FIG. 3

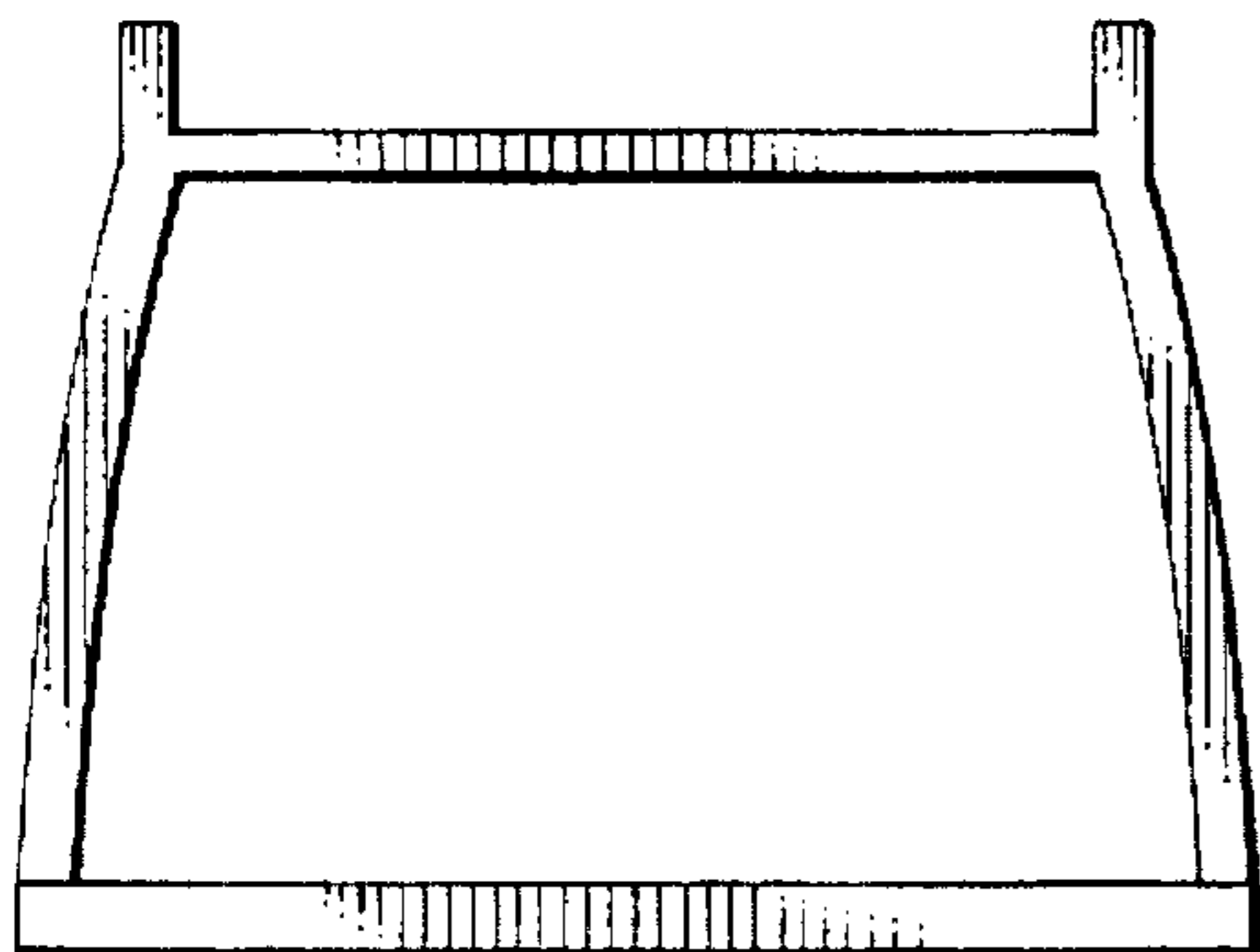

FIG. 4

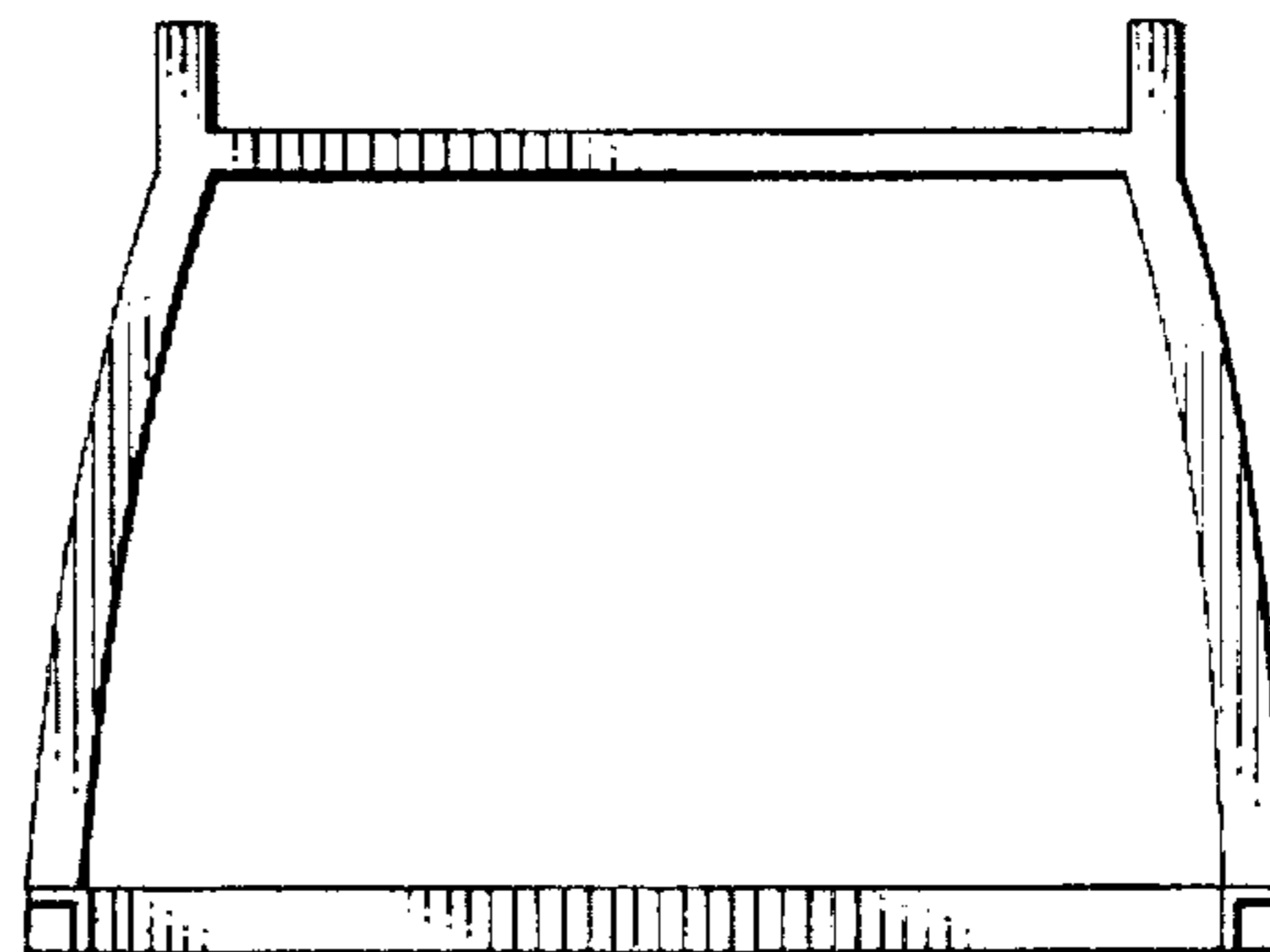

FIG. 5

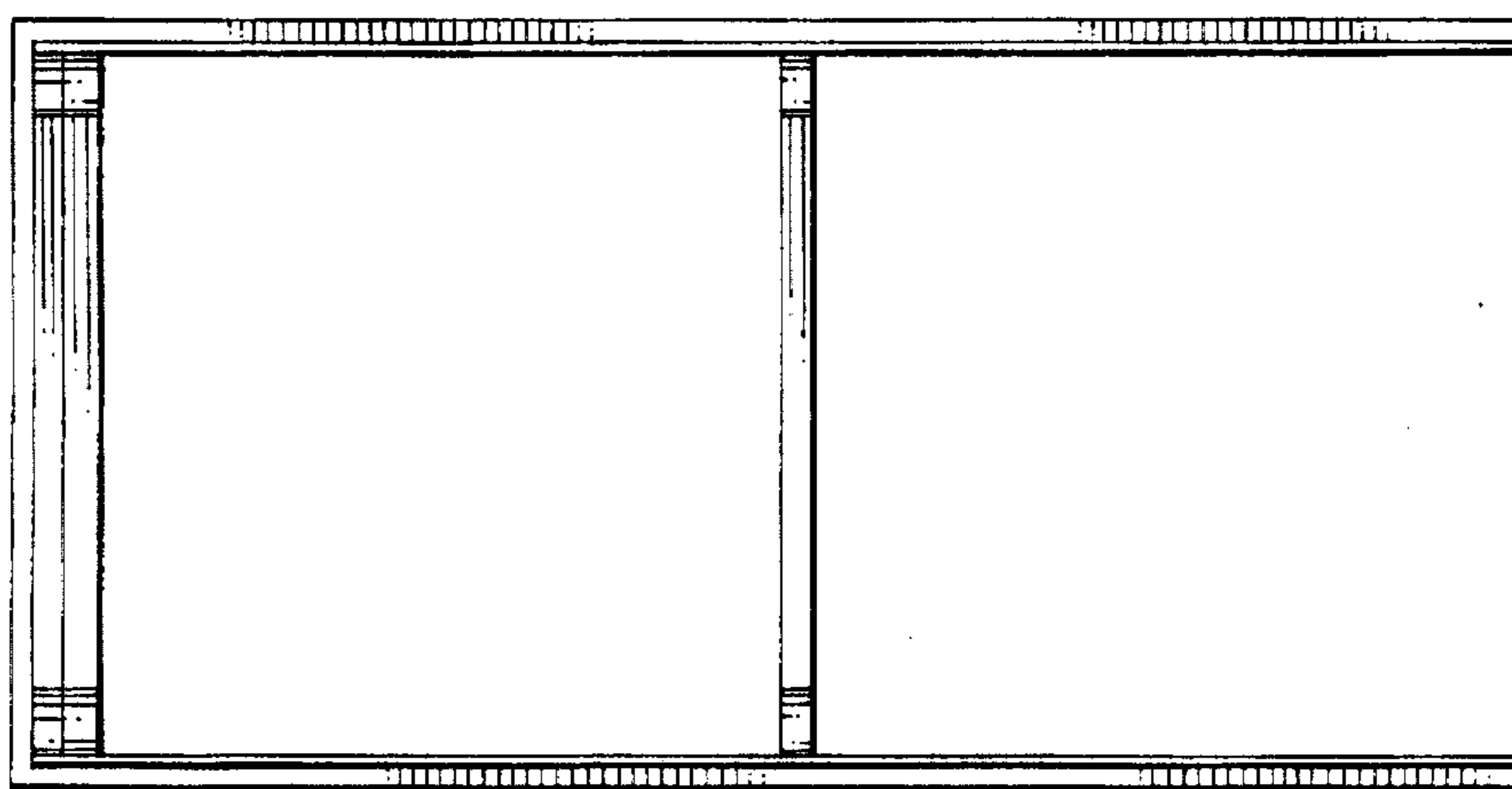

FIG. 6

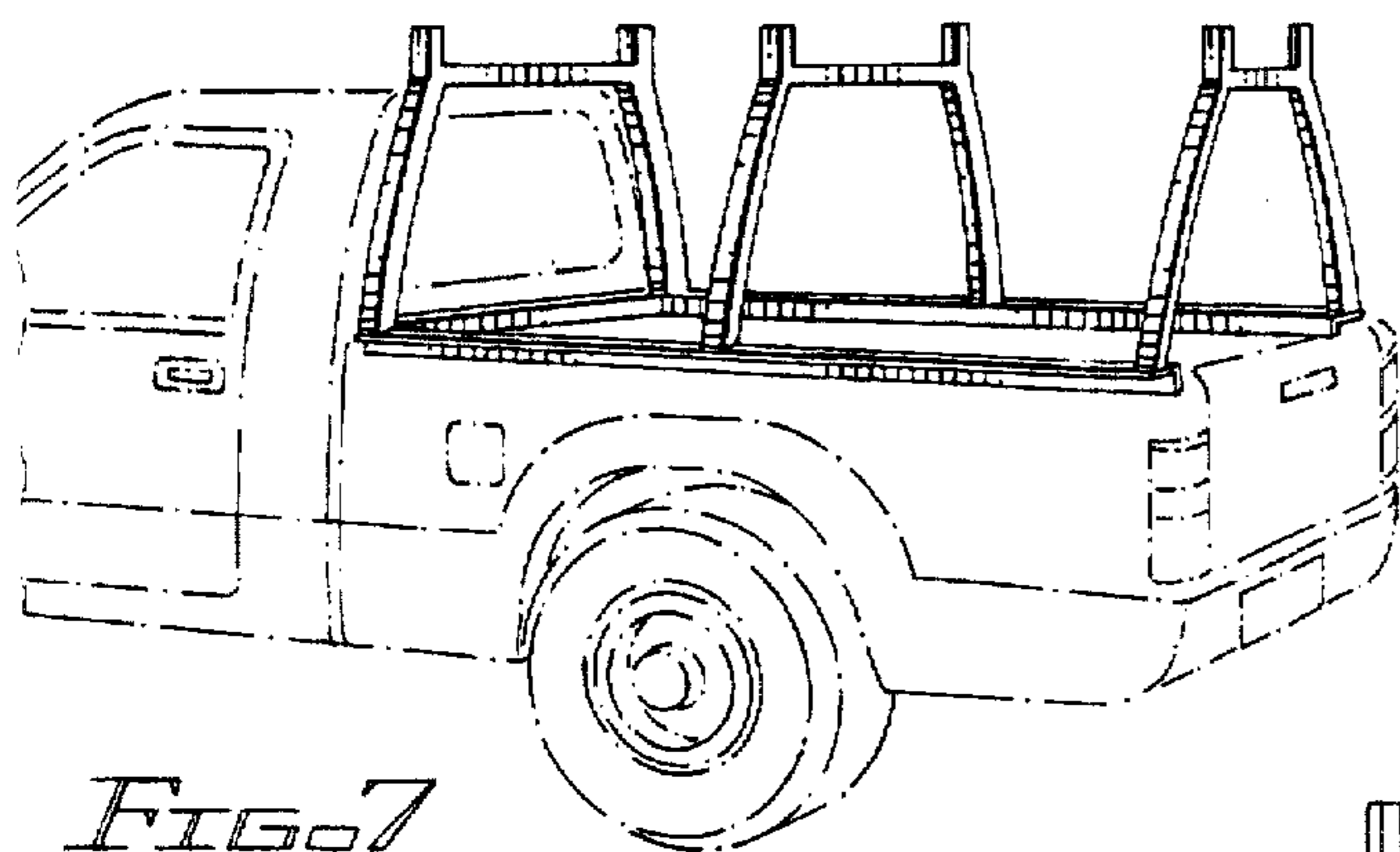

FIG. 7

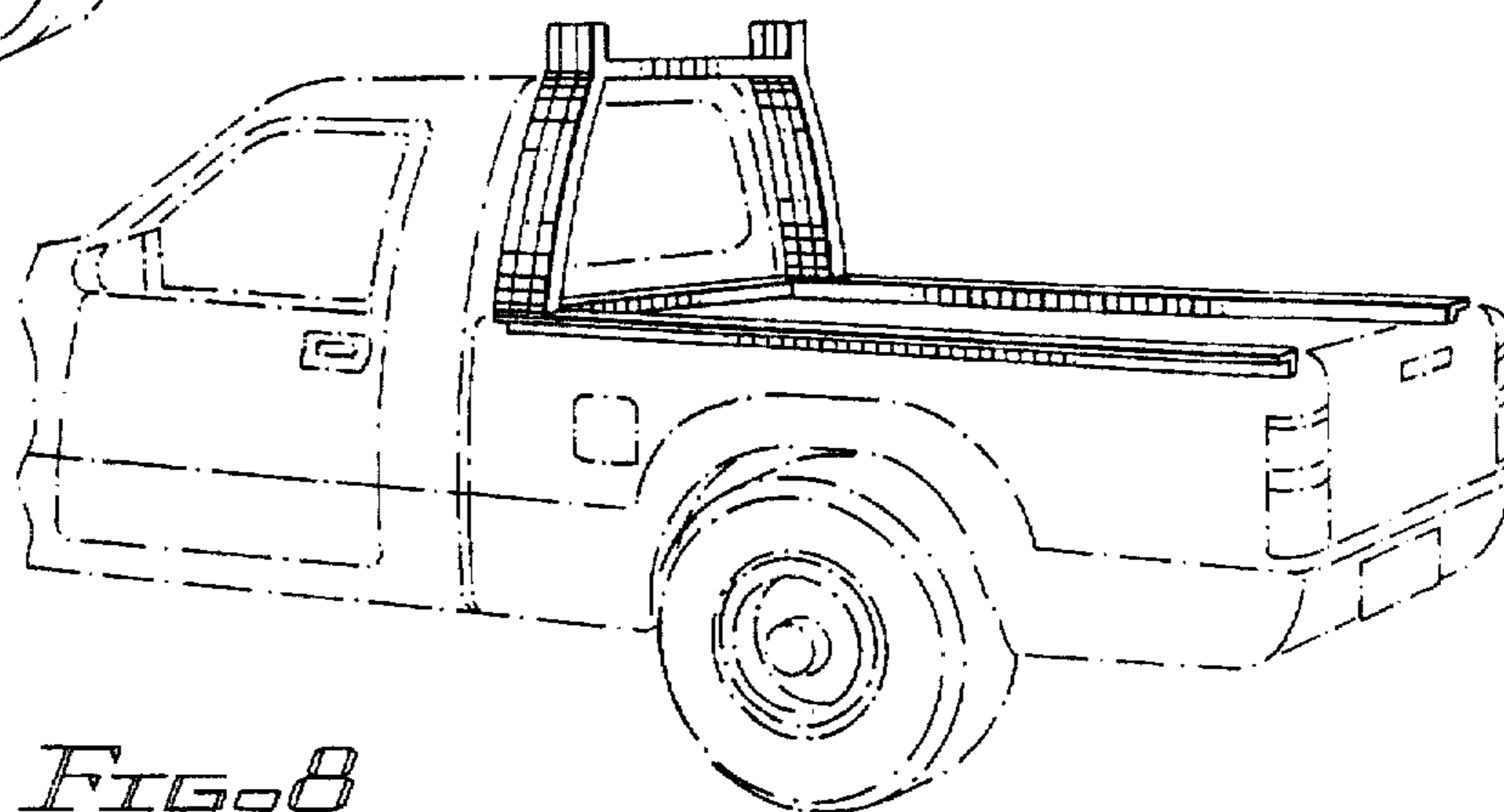

FIG. 8