

US00D394575S

# United States Patent [19]

Mikloczak et al.

[11] Patent Number: **Des. 394,575**

[45] Date of Patent: **\*\*May 26, 1998**

[54] **FISHING ROD HOLDER**

[76] Inventors: **Michael Mikloczak; Eleanor Mikloczak**, both of 1818 E. 11th St., Superior, Wis. 54880

[\*\*] Term: **14 Years**

[21] Appl. No.: **74,434**

[22] Filed: **Aug. 7, 1997**

[51] LOC (6) Cl. .... **06-04**

[52] U.S. Cl. .... **D6/552; D6/457**

[58] Field of Search ..... D6/455, 457, 458, D6/461, 462, 465, 466-468, 469, 552, 534; 211/4, 7, 60.1, 70, 70.1, 70.8, 70.5, 65, 1, 13.1; 43/21.2; 248/121, 505; D21/223; 206/315.6, 315.11

[56] **References Cited**

**U.S. PATENT DOCUMENTS**

D. 234,381	2/1975	Berger	.....	D21/223 X
D. 237,762	11/1975	Hendry	.....	D6/457
D. 261,581	11/1981	Buchanan	.....	D6/552
D. 263,780	4/1982	Hildebrand et al.	.....	D6/457
D. 303,192	9/1989	Bogar, III	.....	D6/552
319,176	6/1885	Bennett	.....	211/65

D. 341,276	11/1993	Jones	.....	D6/457
350,523	10/1886	Bodley	.....	211/65
4,688,685	8/1987	Brace	.....	211/70.5
5,137,319	8/1992	Sauder	.....	211/70.8 X

*Primary Examiner*—James Gandy  
*Assistant Examiner*—Linda Brooks

[57] **CLAIM**

The ornamental design for a fishing rod holder, as shown.

**DESCRIPTION**

FIG. 1 is a front elevation view of the fishing rod holder of the present invention;  
 FIG. 2 is a back elevation view of the fishing rod holder of FIG. 1;  
 FIG. 3 is a left side elevation view of the fishing rod holder of FIG. 1;  
 FIG. 4 is a right side elevation view of the fishing rod holder of FIG. 1;  
 FIG. 5 is a top plan view of the fishing rod holder of FIG. 1;  
 FIG. 6 is a bottom plan view of the fishing rod holder of FIG. 1; and,  
 FIG. 7 is an enlarged perspective view of the fishing rod holder of FIG. 1.

**1 Claim, 4 Drawing Sheets**

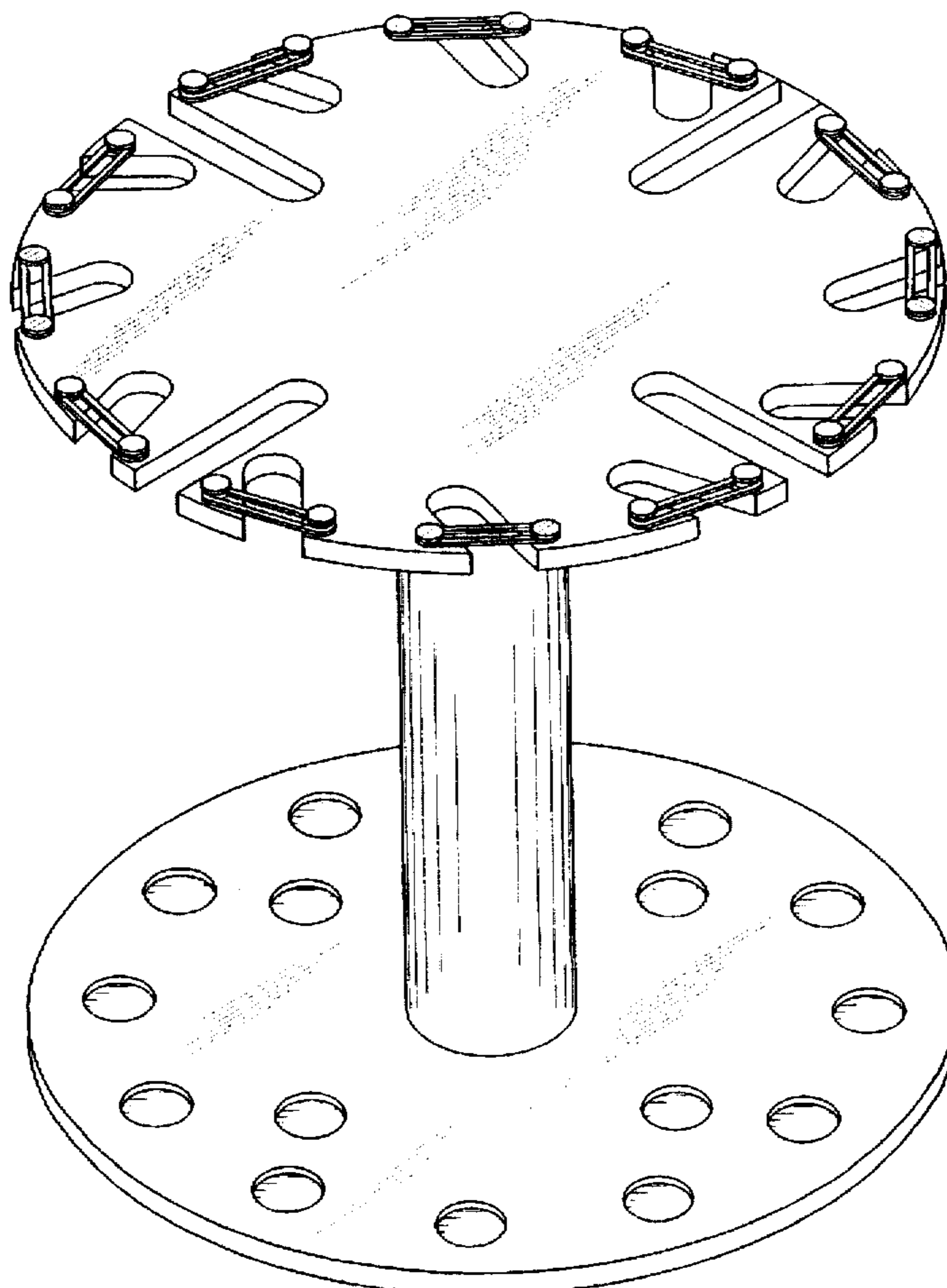

FIG. 1

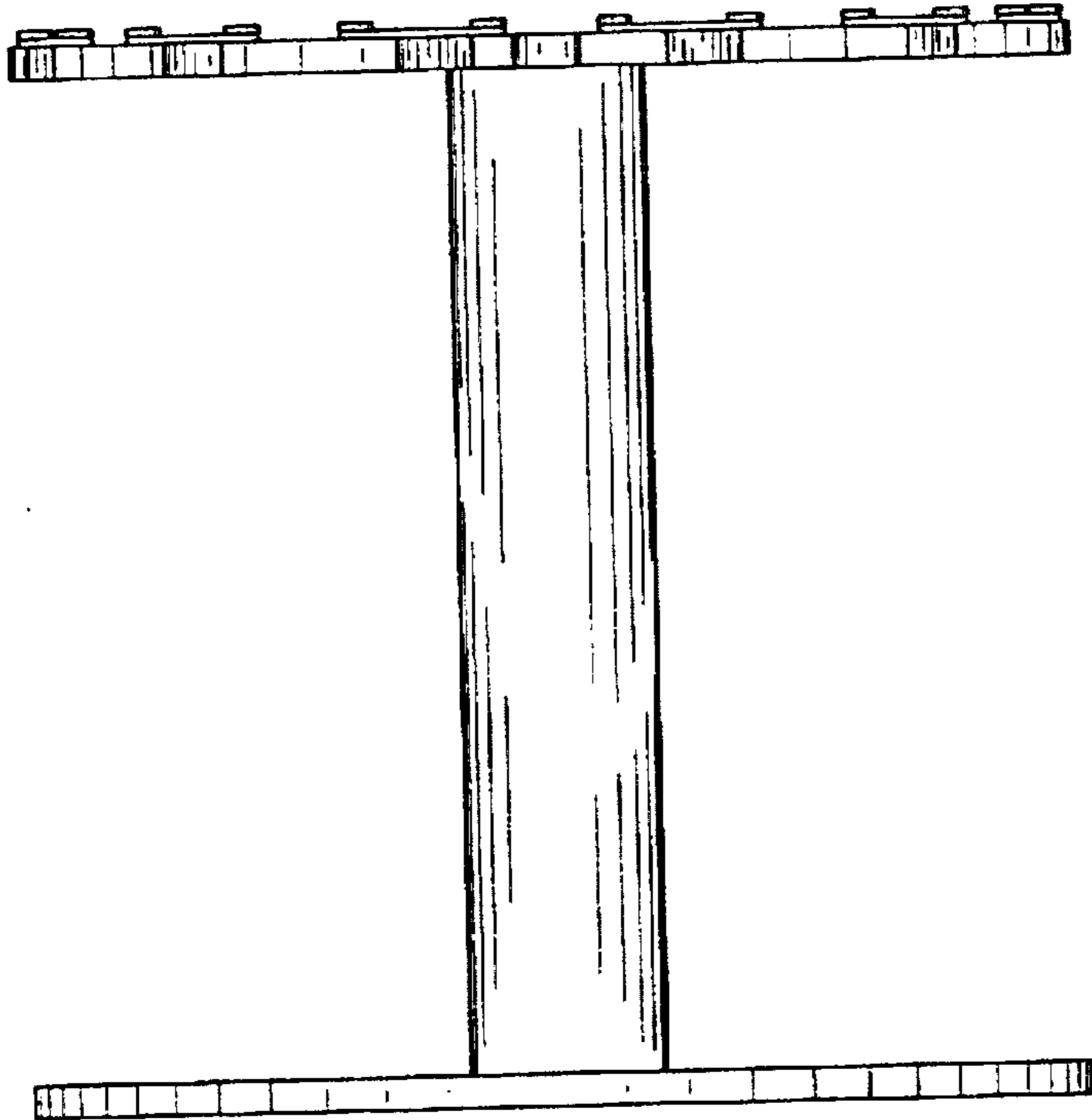
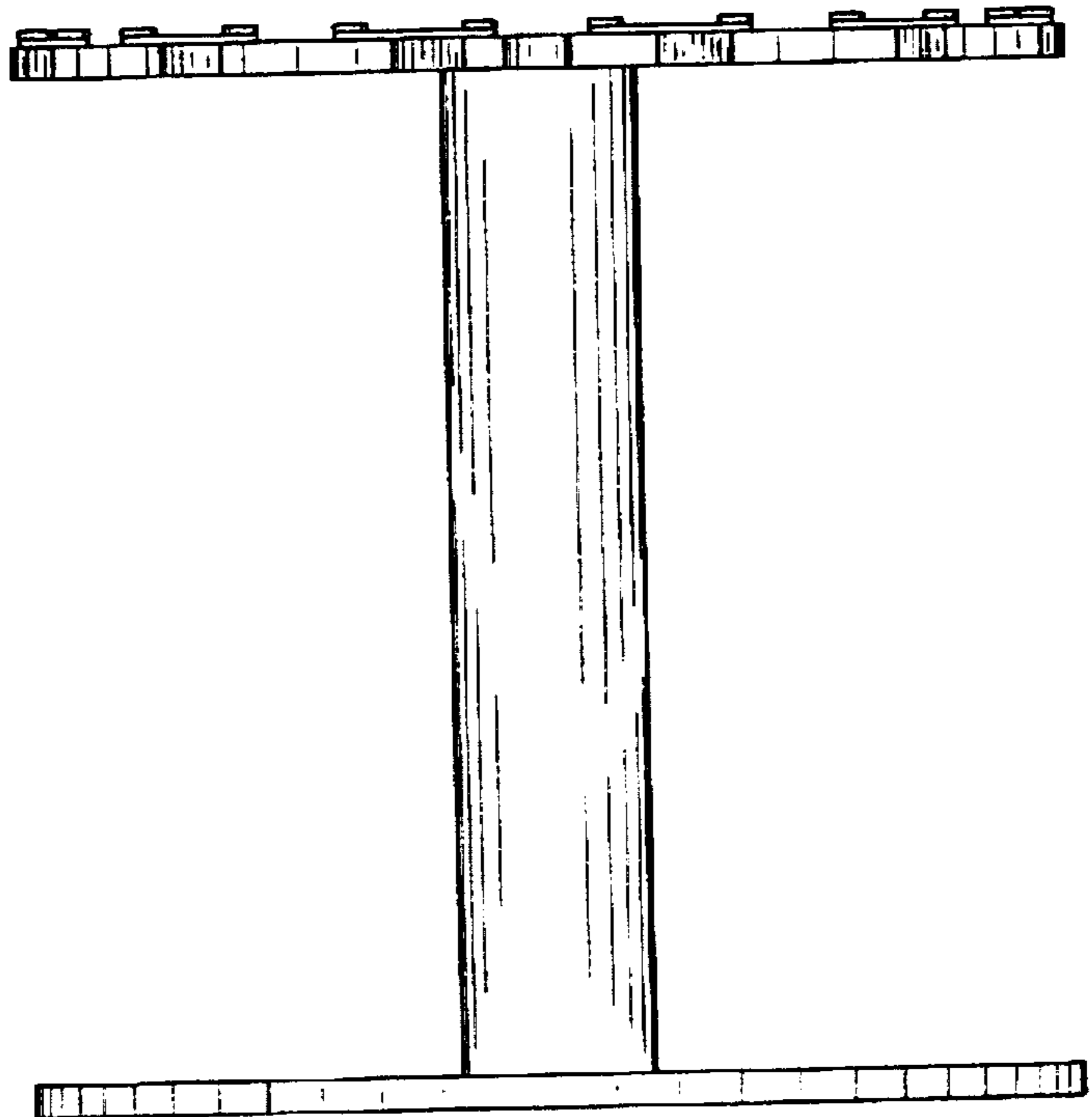
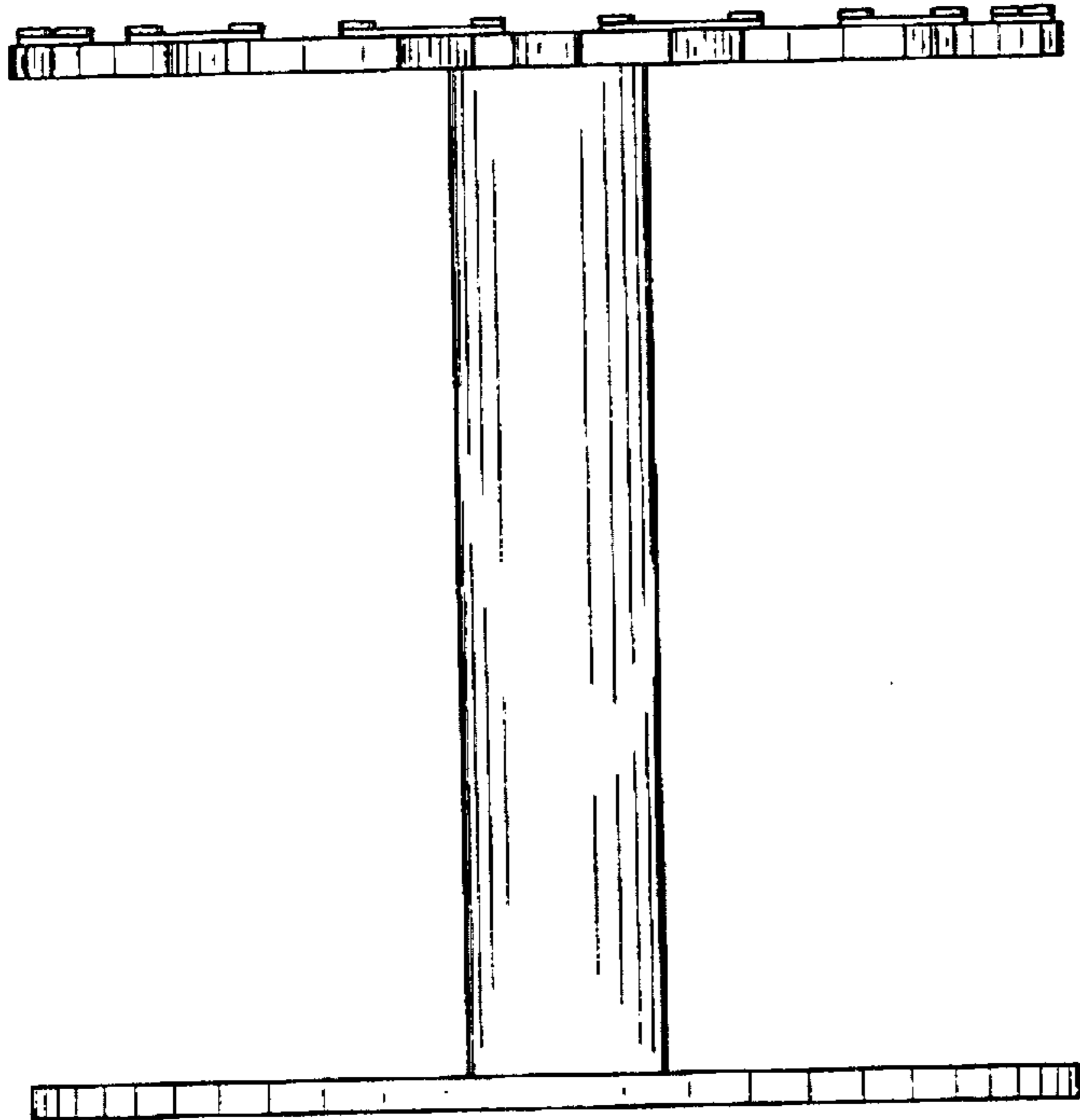

FIG. 2



*FIG. 3*



*FIG. 4*

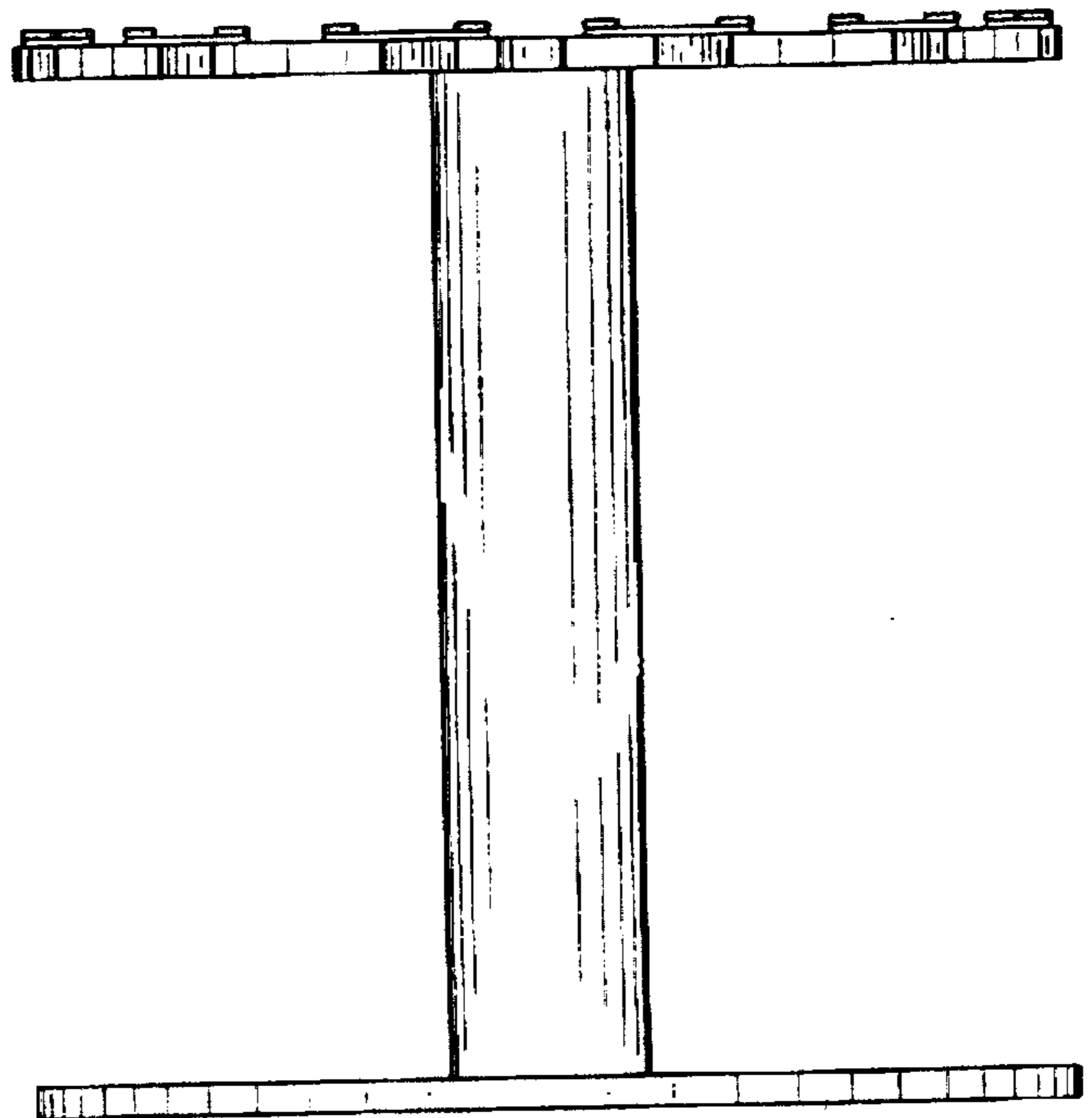

FIG. 5

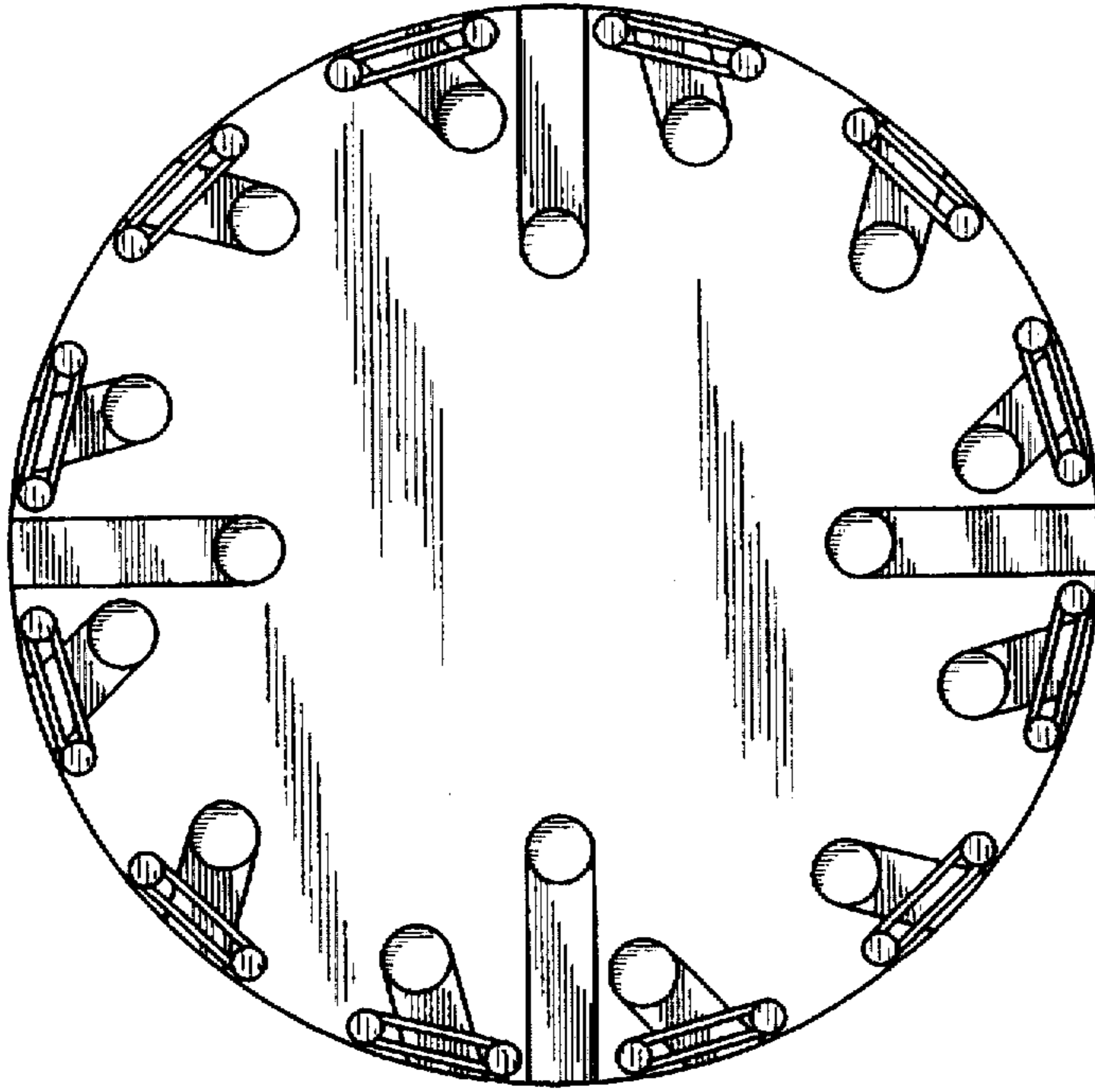

FIG. 6

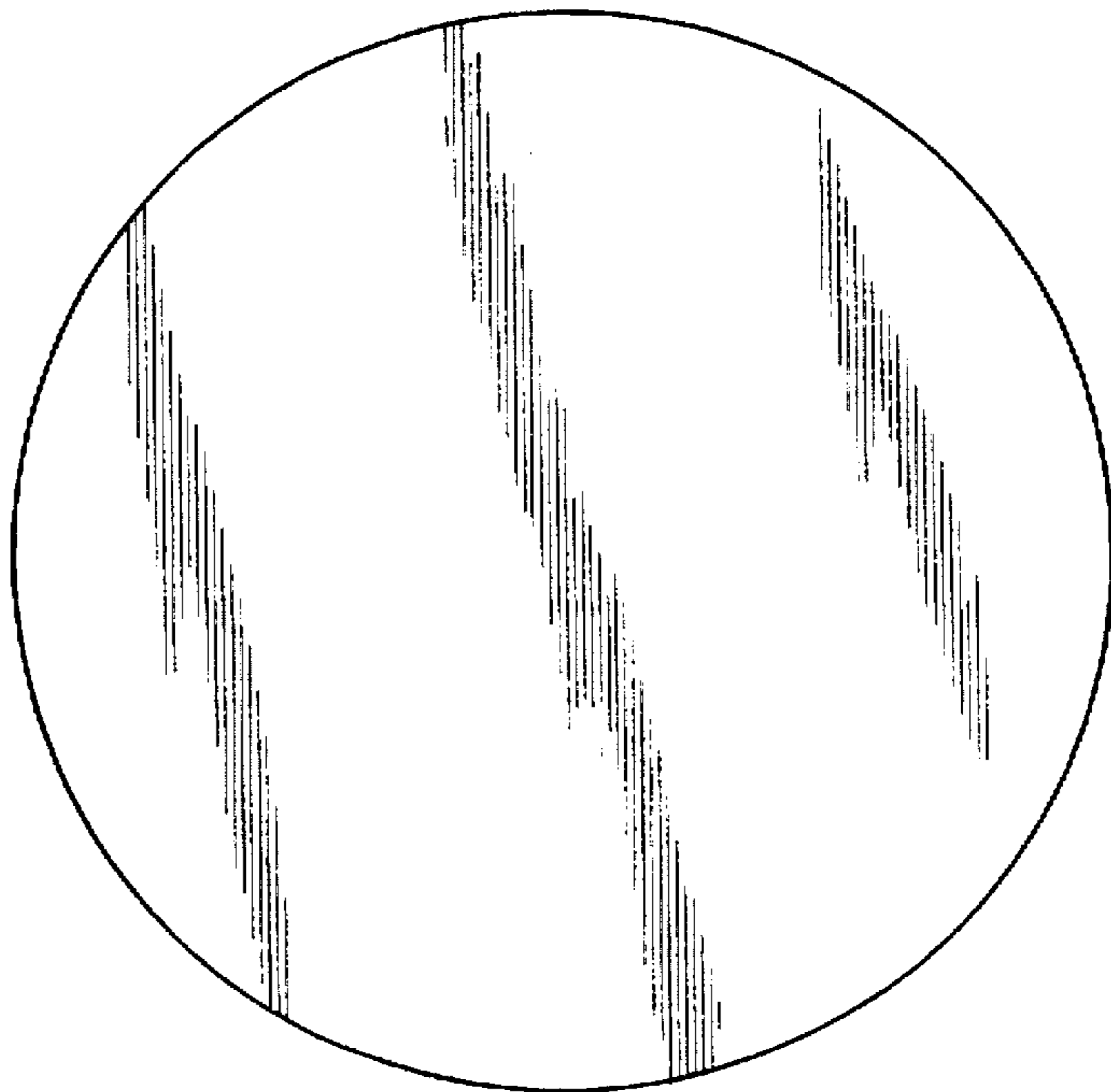

FIG. 7

