



US00D394552S

United States Patent [19]
Melk

[11] **Patent Number:** **Des. 394,552**
[45] **Date of Patent:** ****May 26, 1998**

[54] **PORTABLE DEVICE AND ACCESSORY STORAGE CASE**

D. 373,514 9/1996 Melk D3/287
5,322,162 6/1994 Melk 206/310

[75] **Inventor:** **Thomas J. Melk, Chicago, Ill.**

Primary Examiner—Philip S. Hyder
Attorney, Agent, or Firm—Trexler, Bushnell, Giangiorgi & Blackstone, Ltd.

[73] **Assignee:** **Outer Circle Products, Ltd., Chicago, Ill.**

[57] **CLAIM**

[**] **Term:** **14 Years**

The ornamental design for a portable device and accessory storage case, as shown.

[21] **Appl. No.:** **52,244**

DESCRIPTION

[22] **Filed:** **Mar. 26, 1996**

[51] **LOC (6) Cl.** **03-01**

[52] **U.S. Cl.** **D3/287; D3/289; D7/607**

[58] **Field of Search** **D3/287, 283, 289, D3/301; 190/109, 110, 111, 112, 113, 114, 115; 206/315.1, 316.1, 316.2, 320; D7/607**

FIG. 1 is a perspective view of the portable device and accessory storage case showing the design;
FIG. 2 is a front elevational view thereof;
FIG. 3 is a top plan view thereof;
FIG. 4 is a rear elevational view thereof;
FIG. 5 is a bottom plan view thereof;
FIG. 6 is a left side elevational view thereof;
FIG. 7 is a right side elevational view thereof;
FIG. 8 is a perspective view of a second embodiment of the portable device and accessory storage case showing the design;
FIG. 9 is a front elevational view thereof;
FIG. 10 is a top plan view thereof;
FIG. 11 is a rear elevational view thereof;
FIG. 12 is a bottom plan view thereof;
FIG. 13 is a left side elevational view thereof; and,
FIG. 14 is a right side elevational view thereof.

[56] **References Cited**

U.S. PATENT DOCUMENTS

D. 273,533	4/1984	Weinreb	D3/287
D. 279,939	8/1985	Richardson et al.	D3/287
D. 307,672	5/1990	Lam	D3/287
D. 340,387	10/1993	Melk	D3/289
D. 340,621	10/1993	Melk	D3/287
D. 343,732	2/1994	McConnell	D3/287
D. 349,191	8/1994	Mason	D3/289
D. 355,568	2/1995	Paulin et al.	D7/607
D. 371,724	7/1996	Melk	D7/607

1 Claim, 8 Drawing Sheets

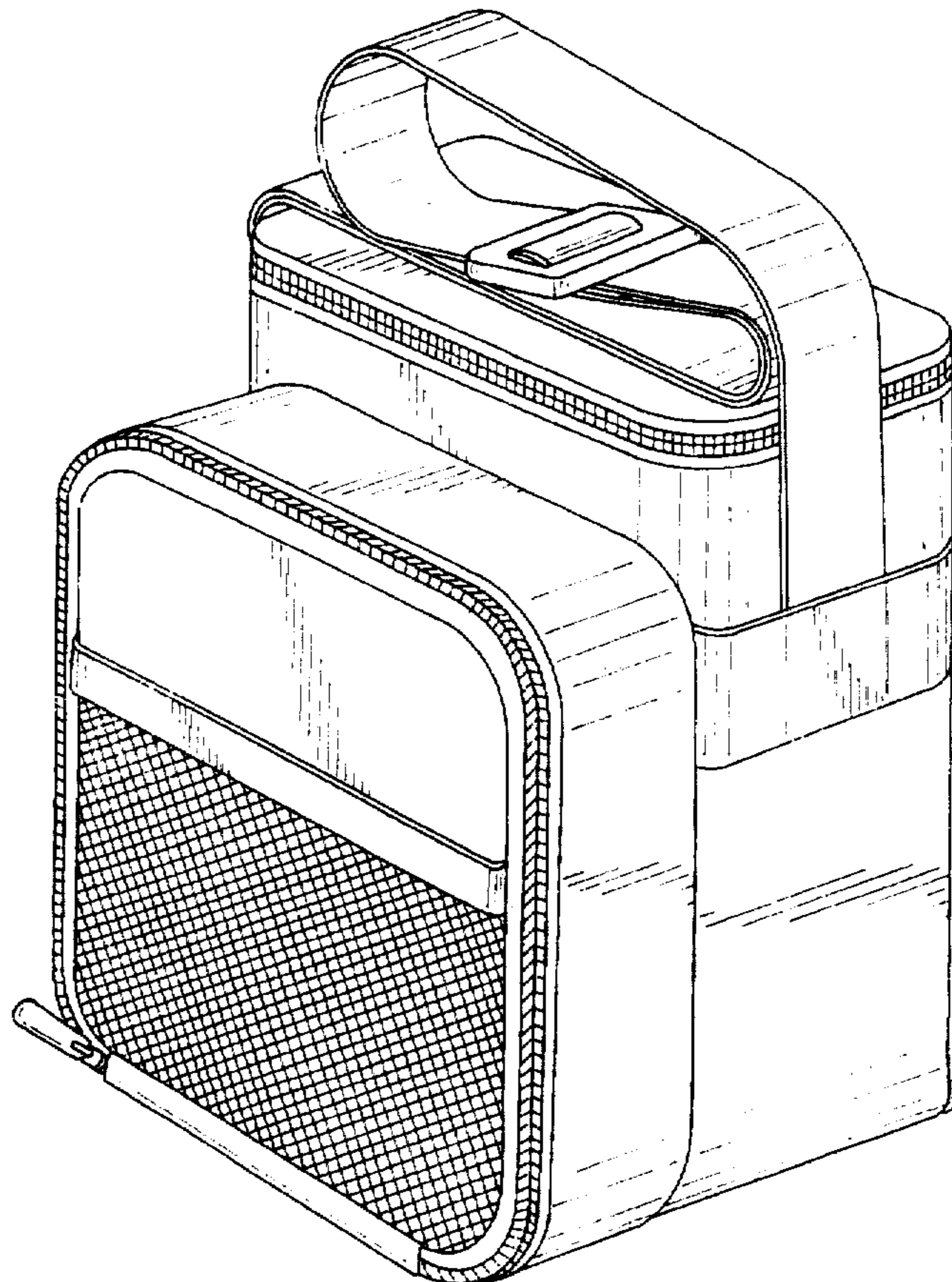

FIG. 1

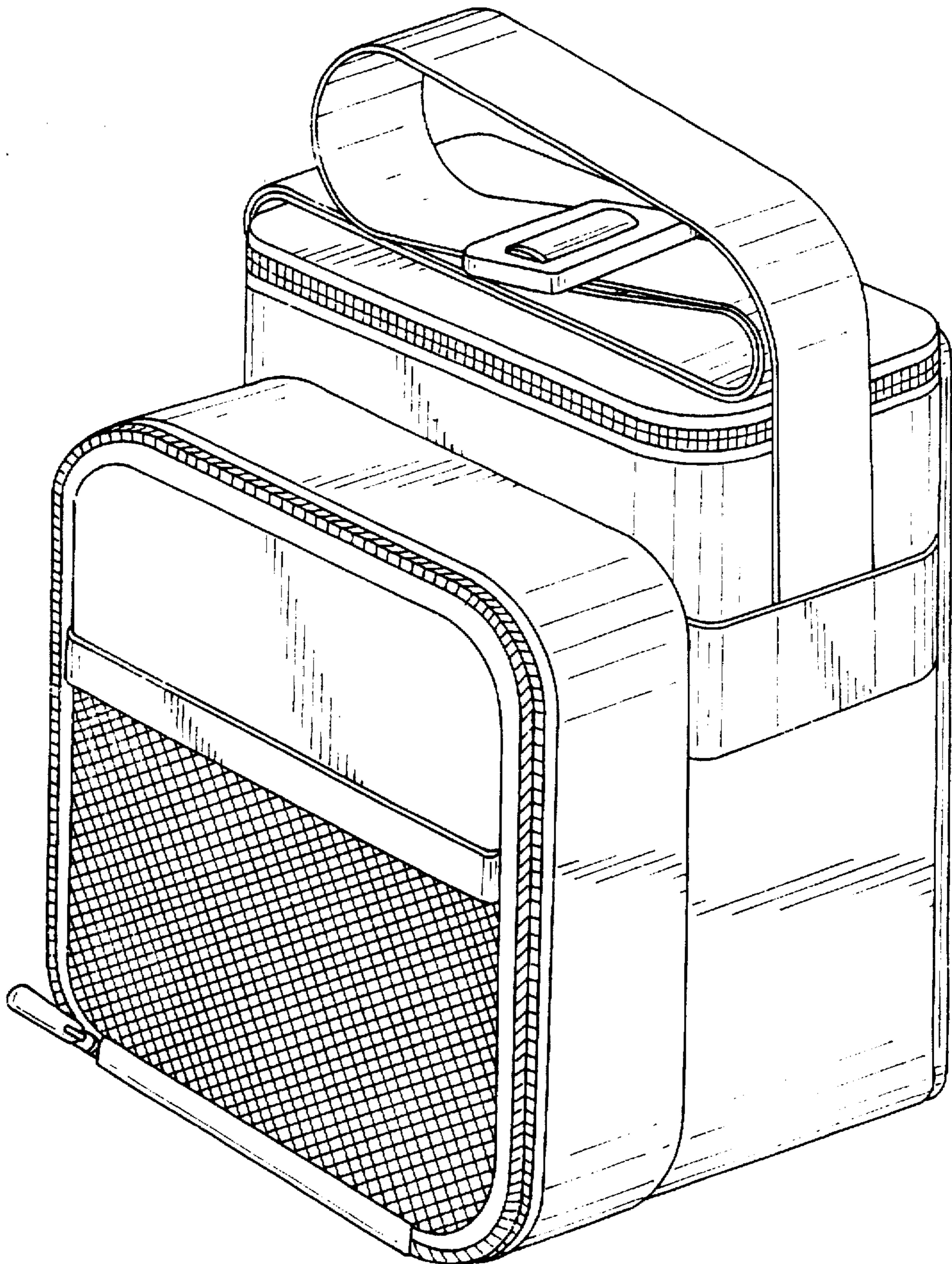

FIG. 2

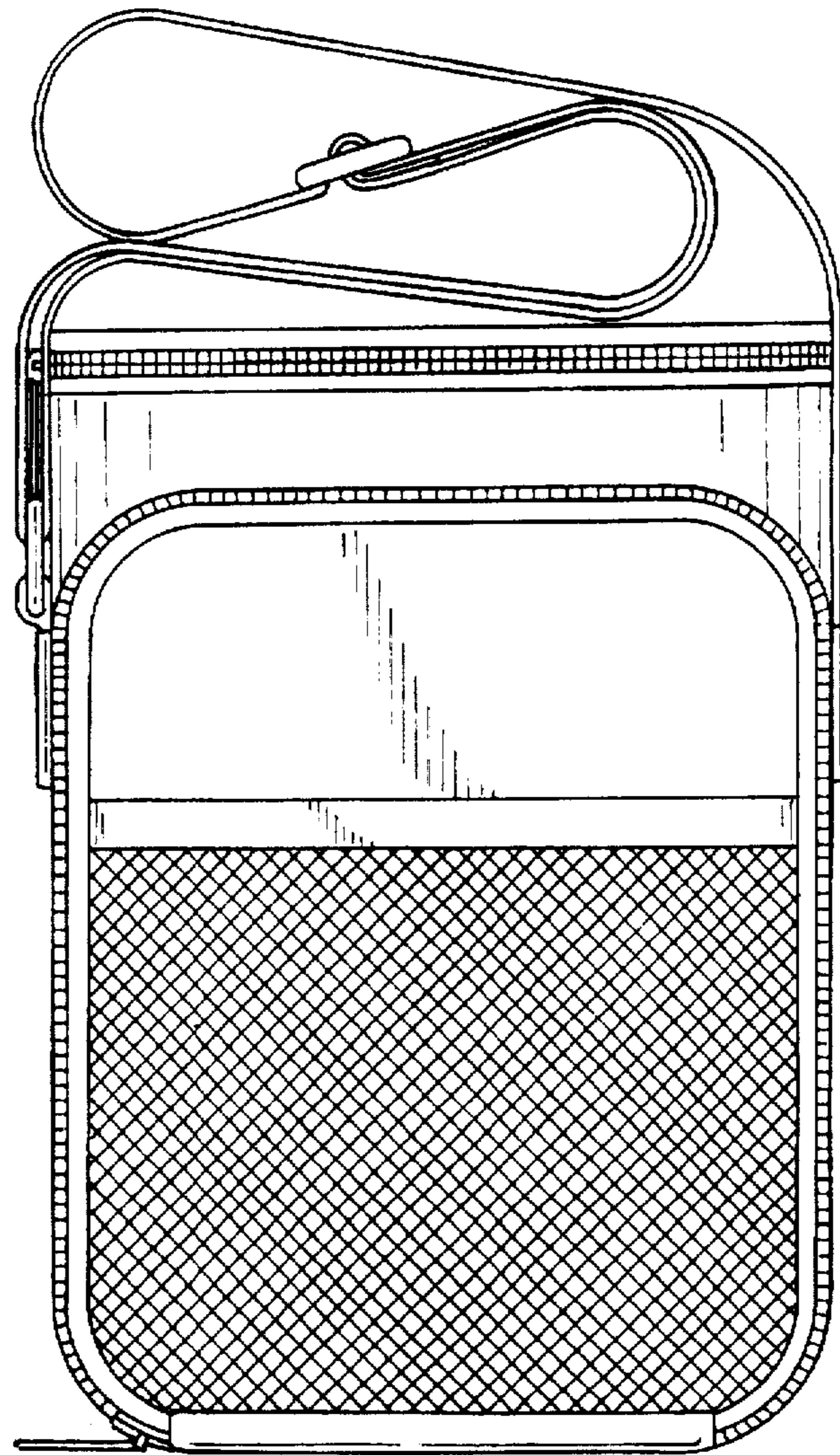

FIG. 3

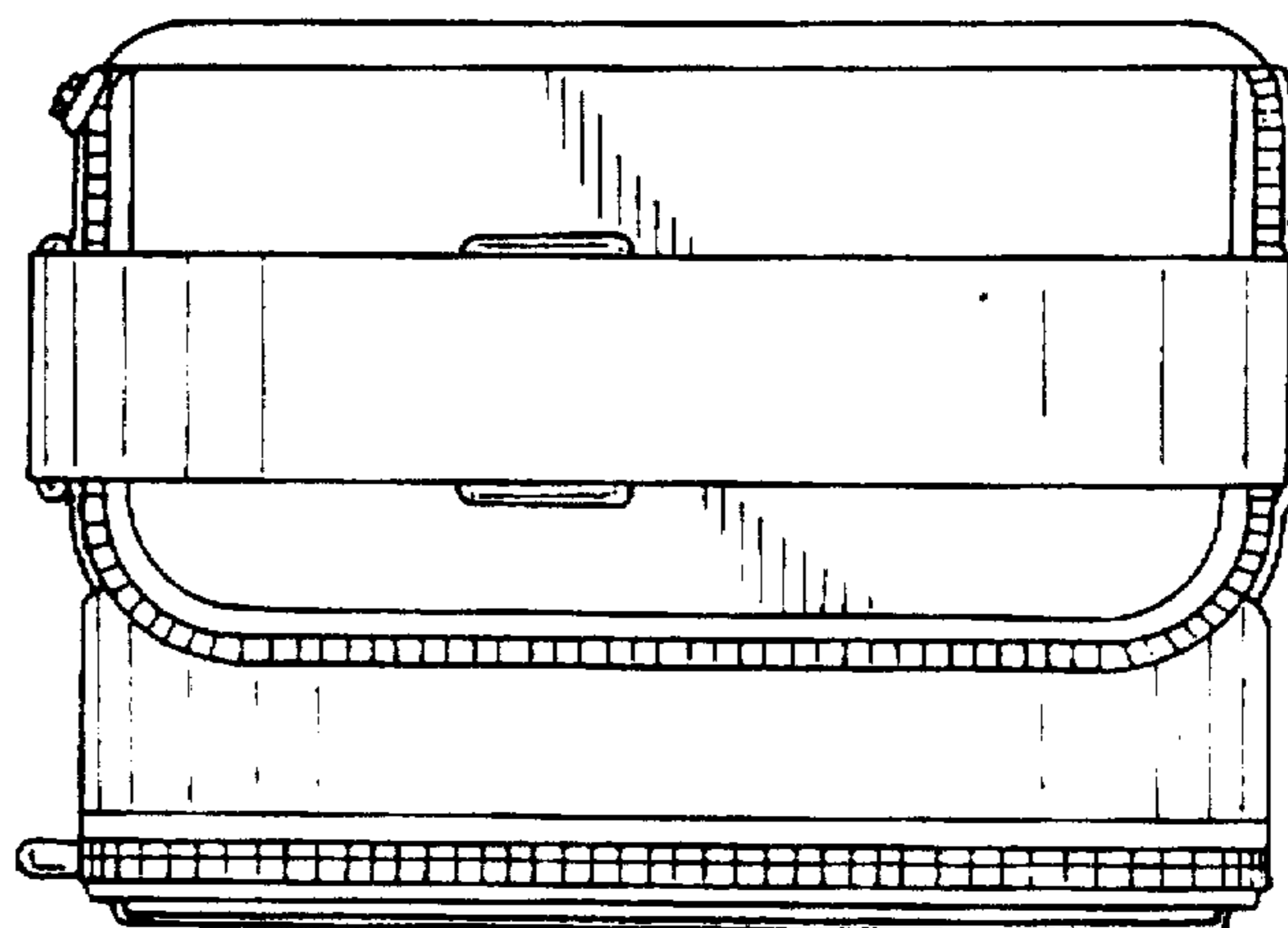

FIG. 4

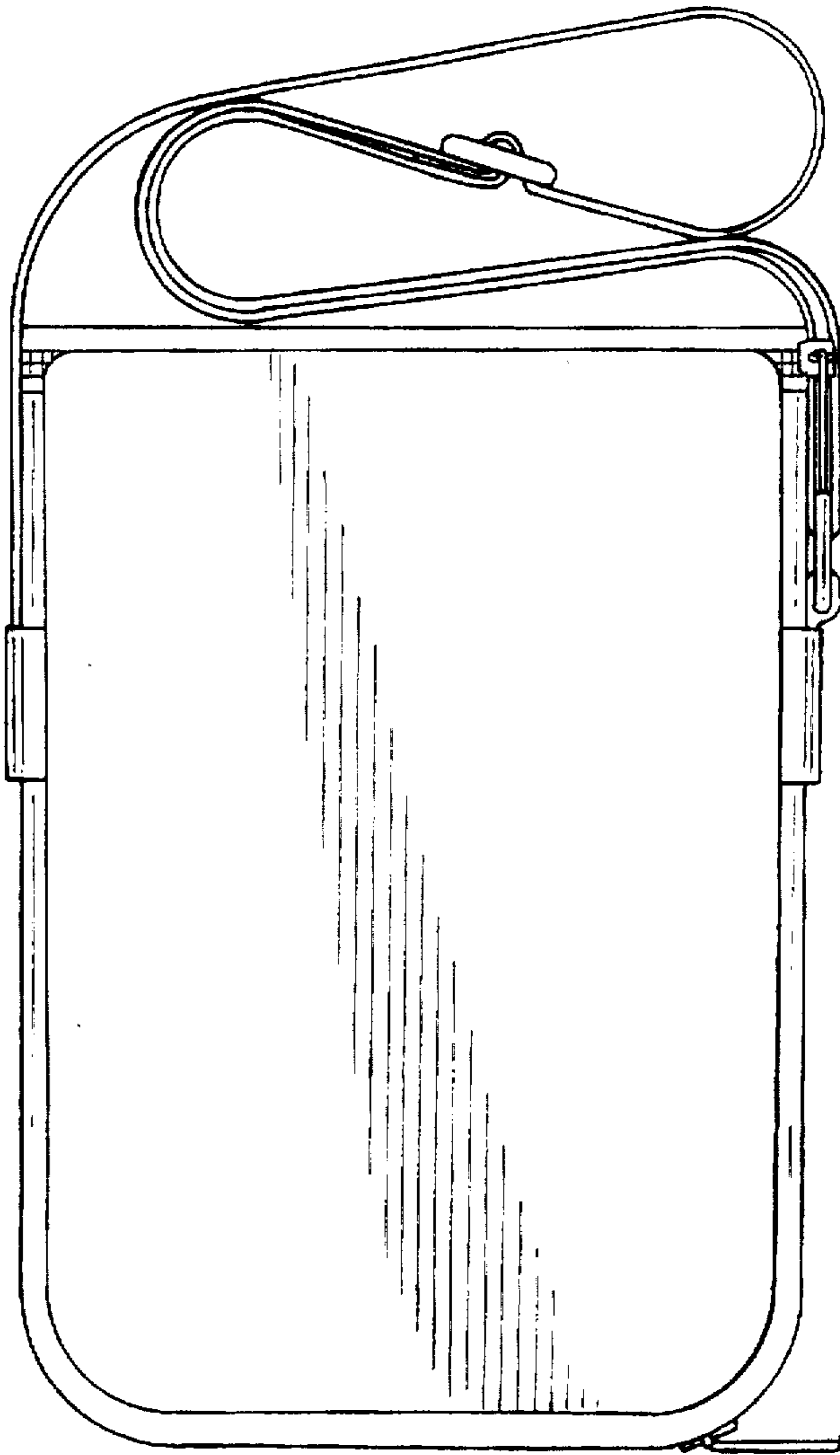
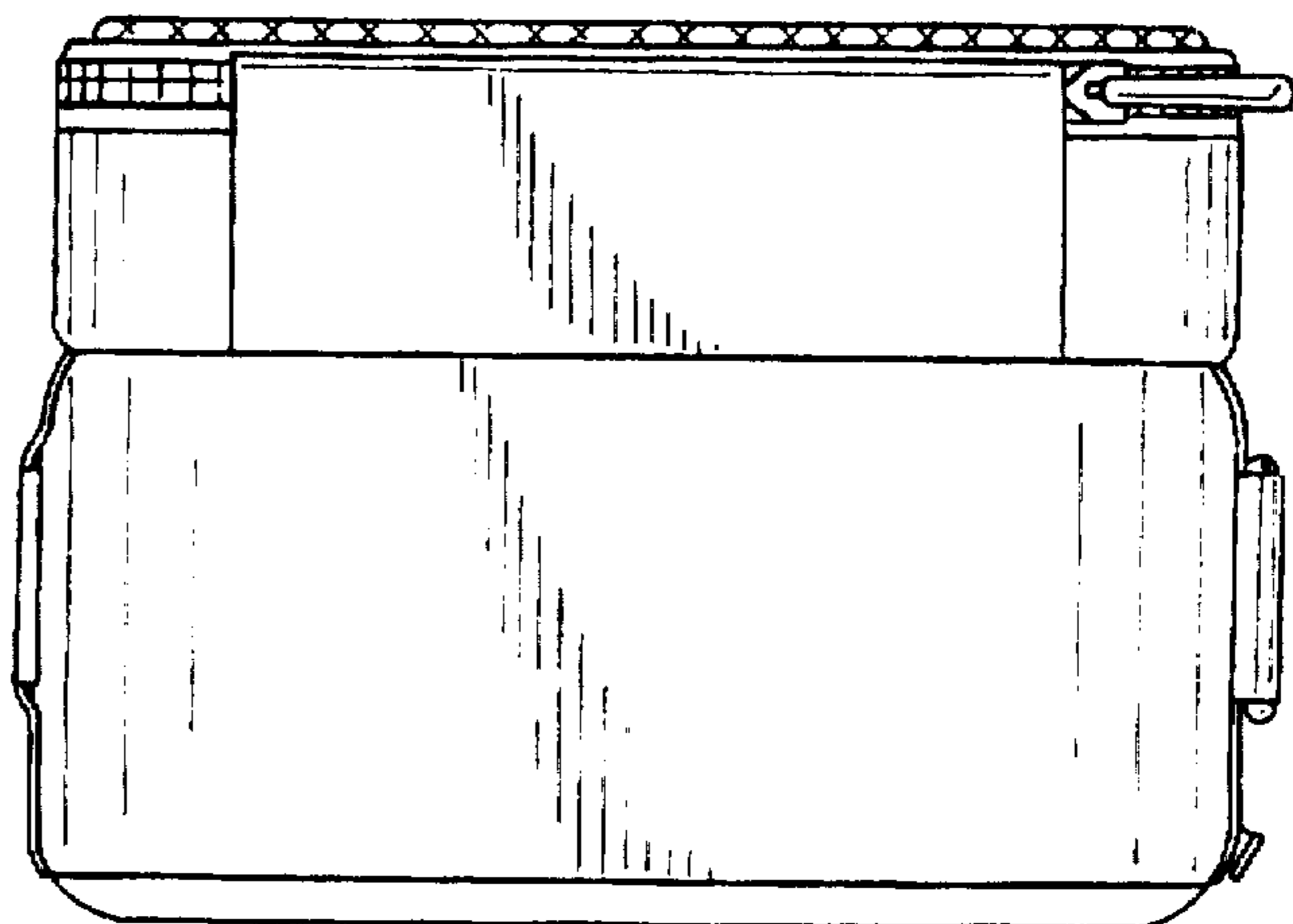

FIG. 5



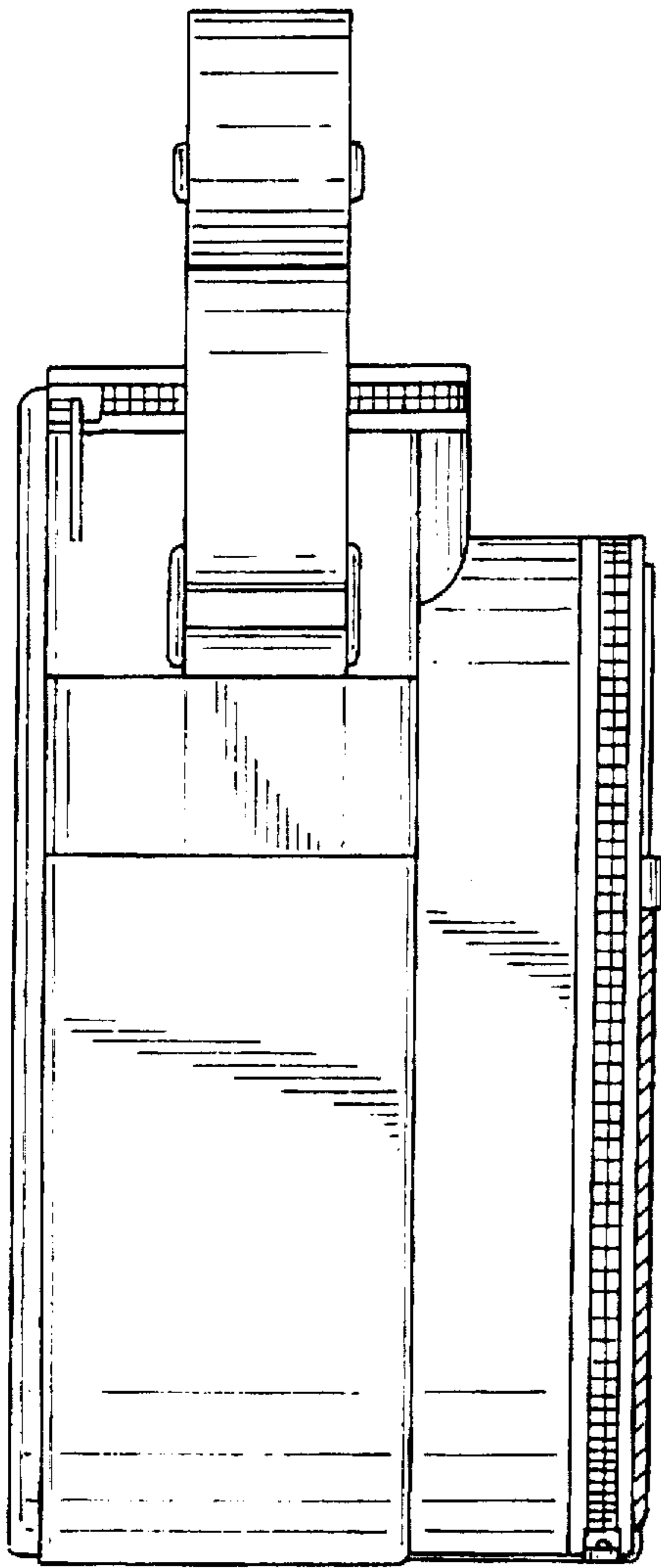

FIG. 6

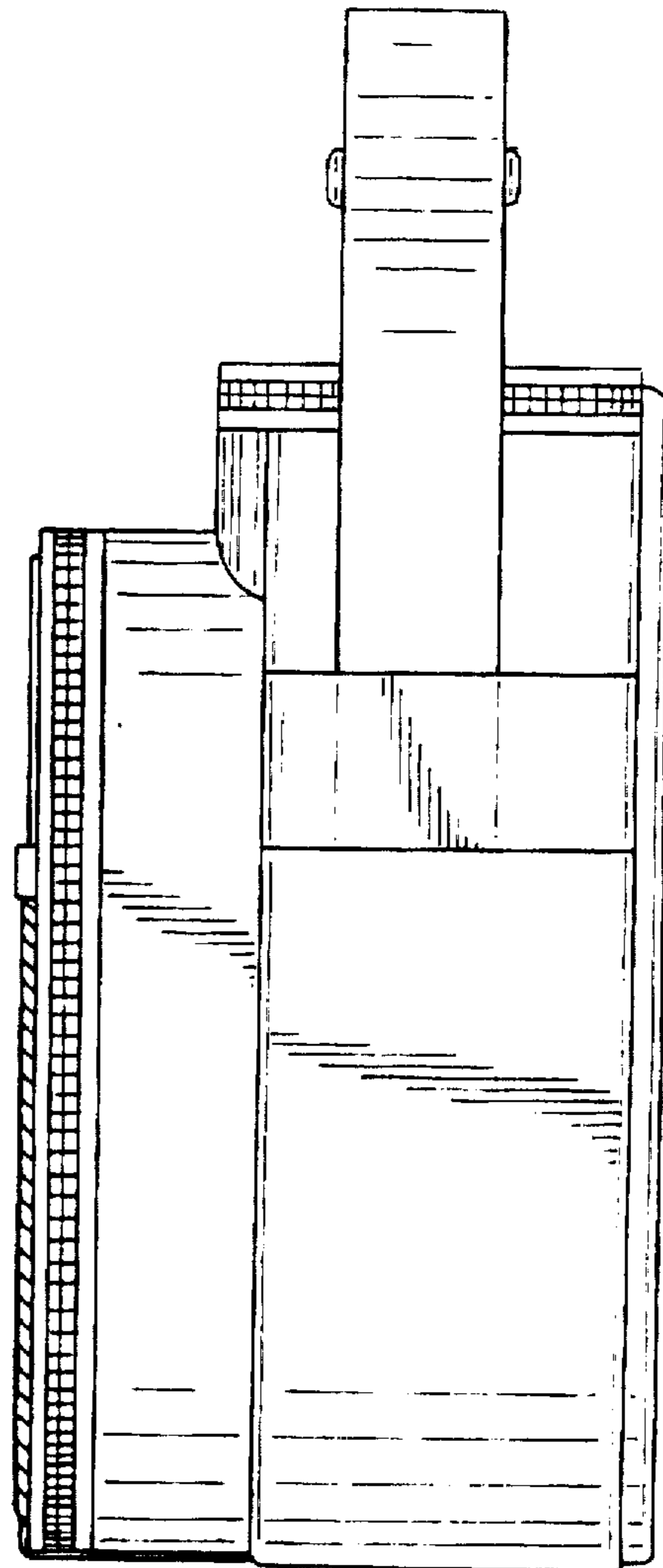

FIG. 7

FIG. 8

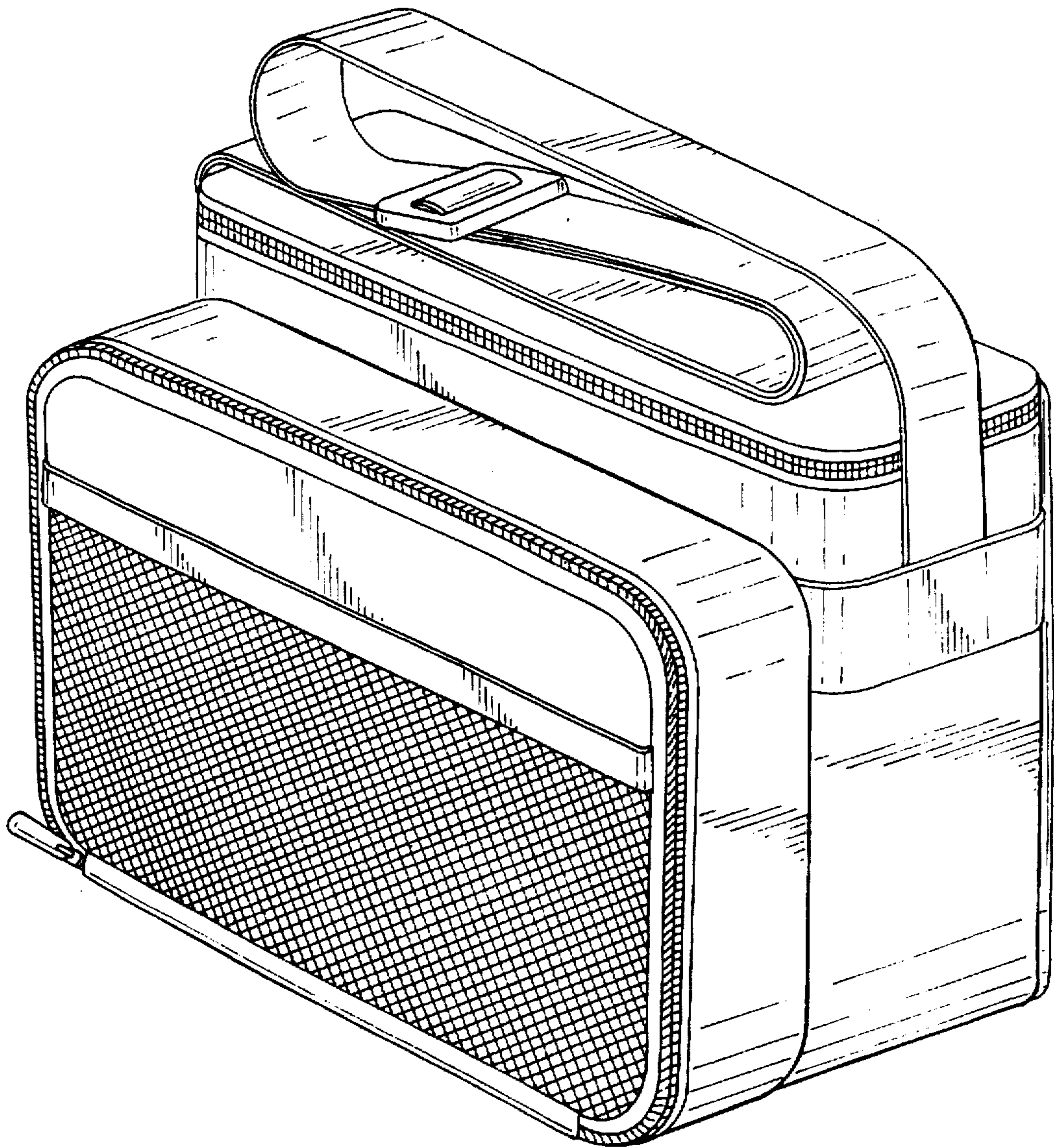

FIG. 9

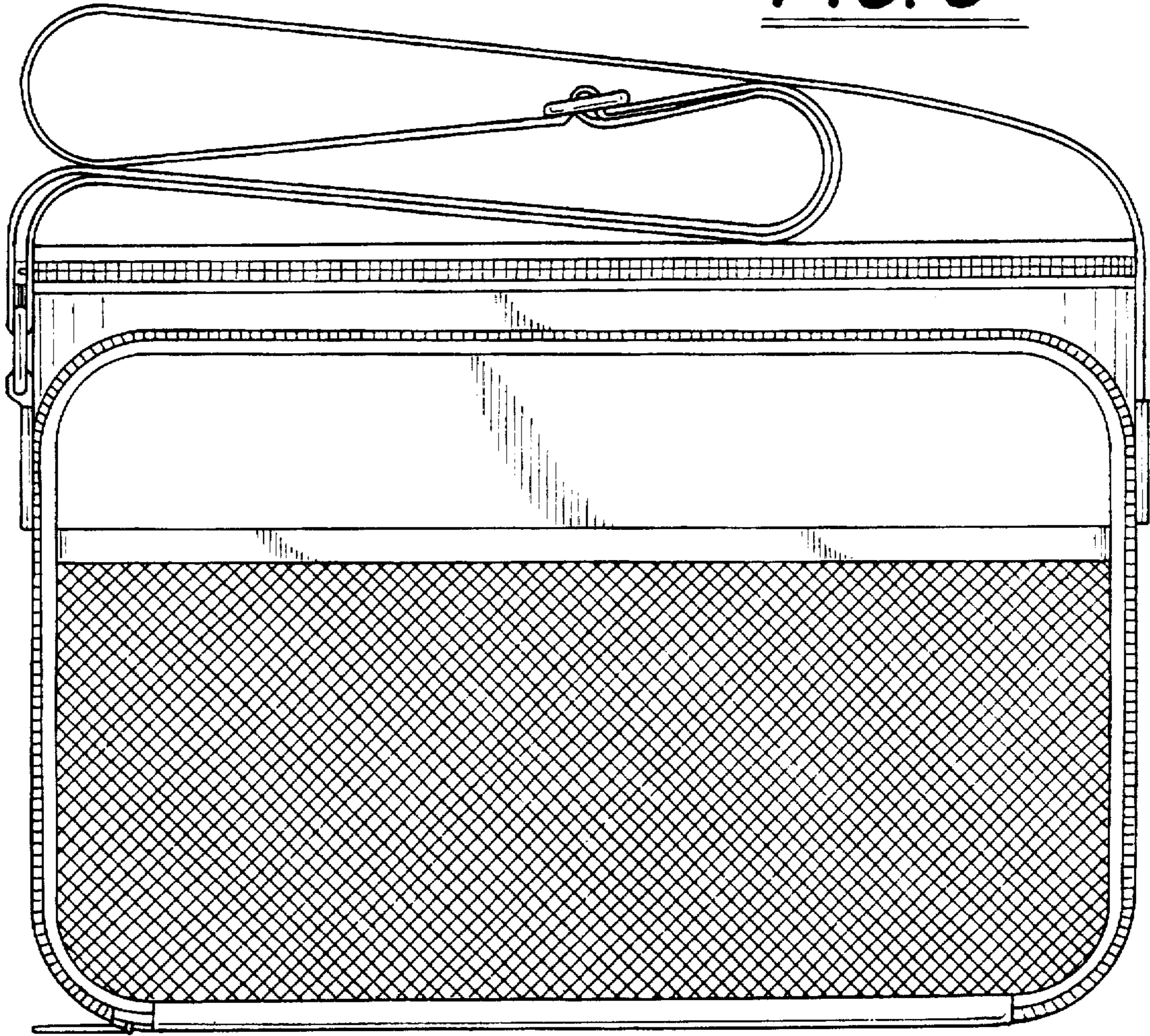

FIG. 10

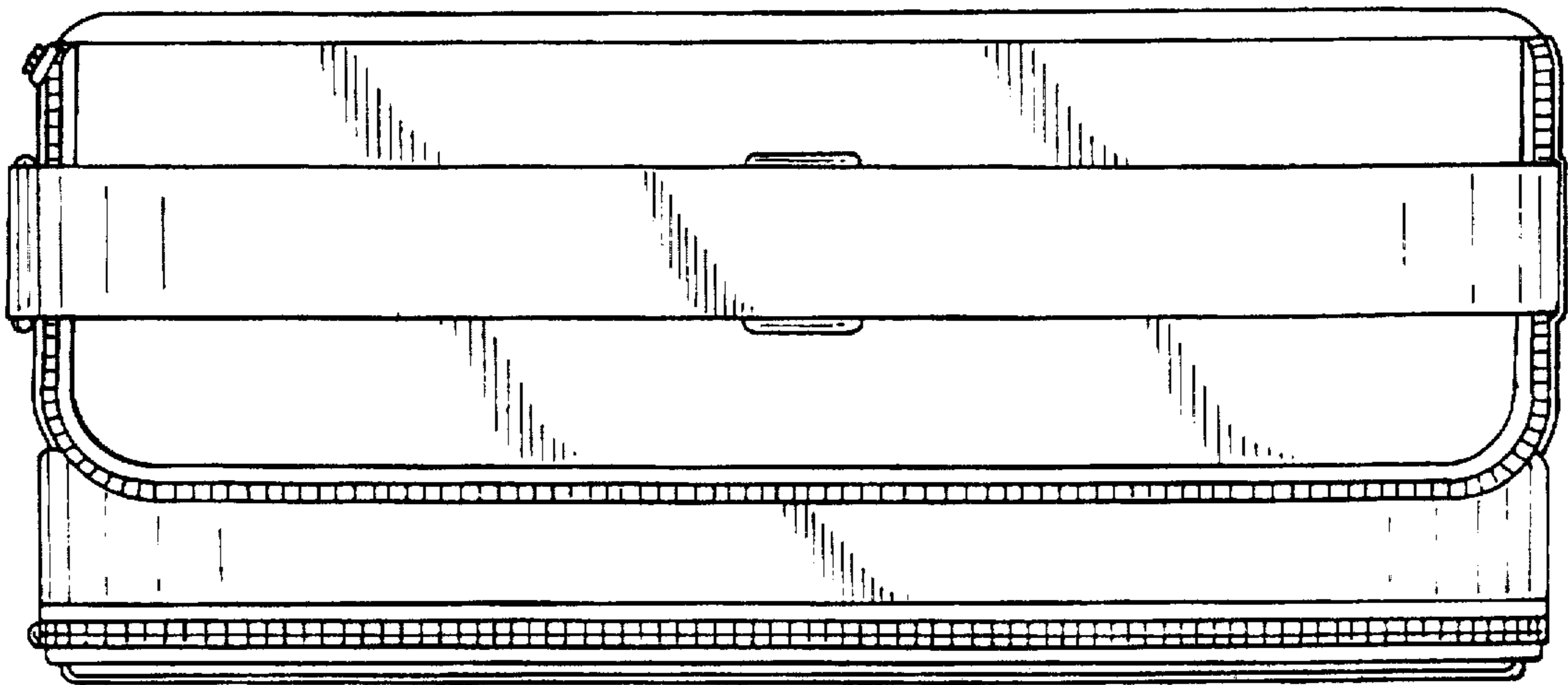

FIG. 11

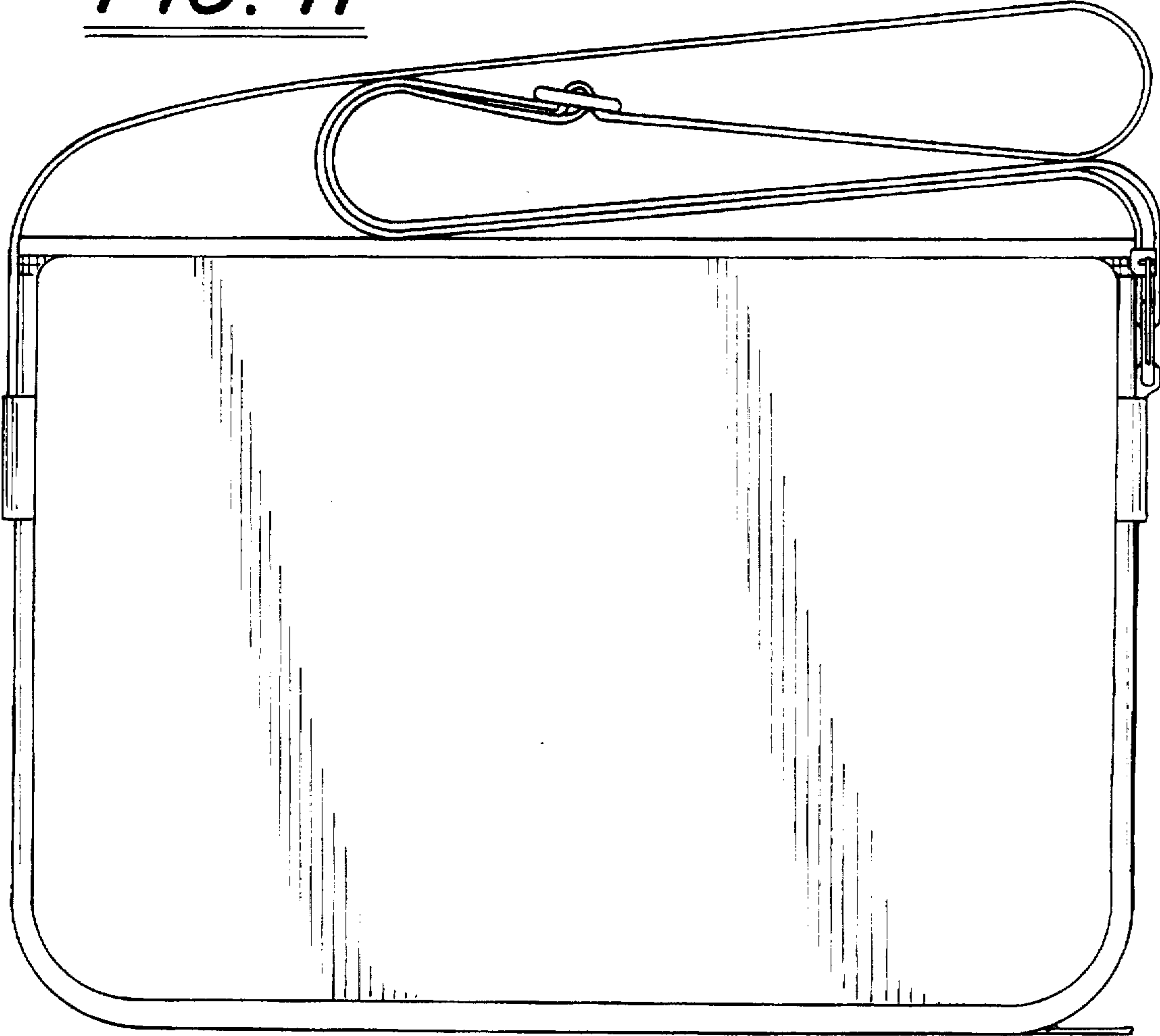
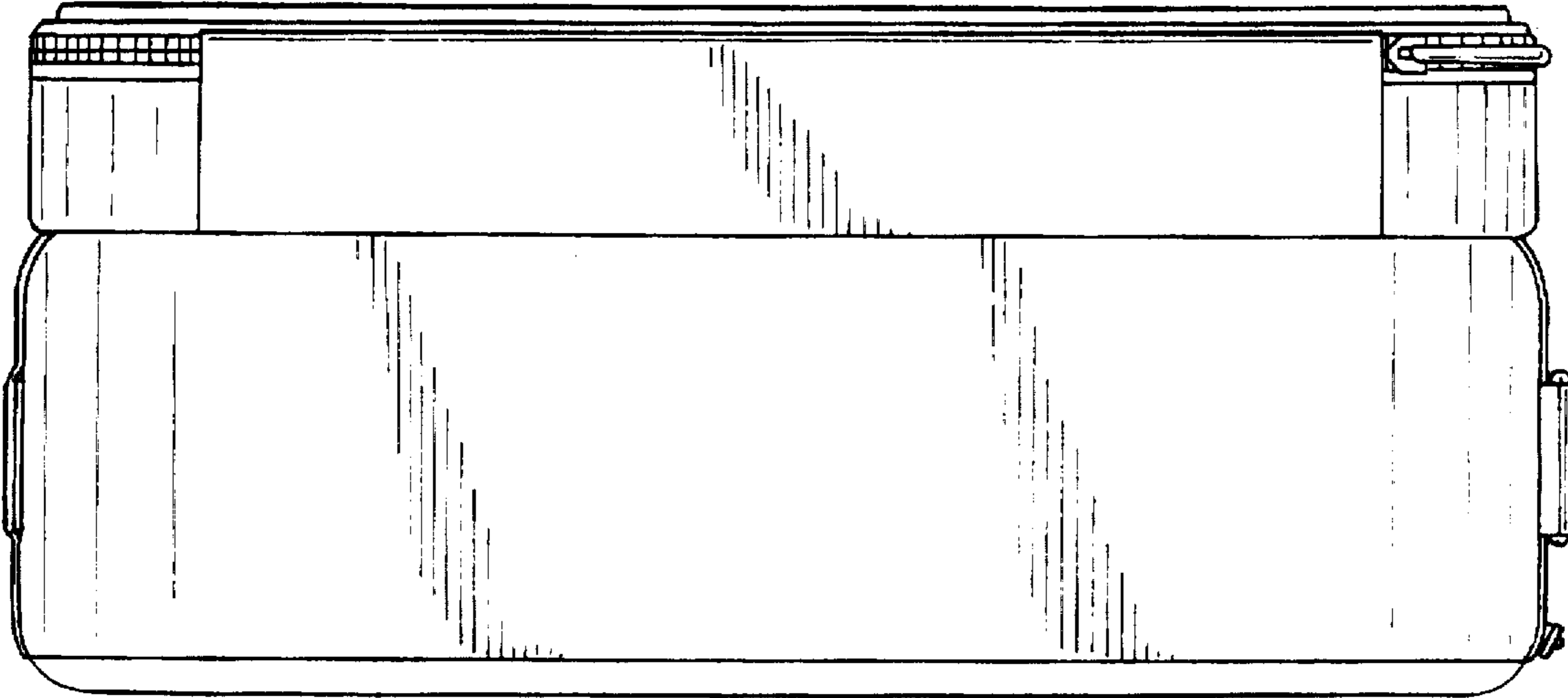

FIG. 12



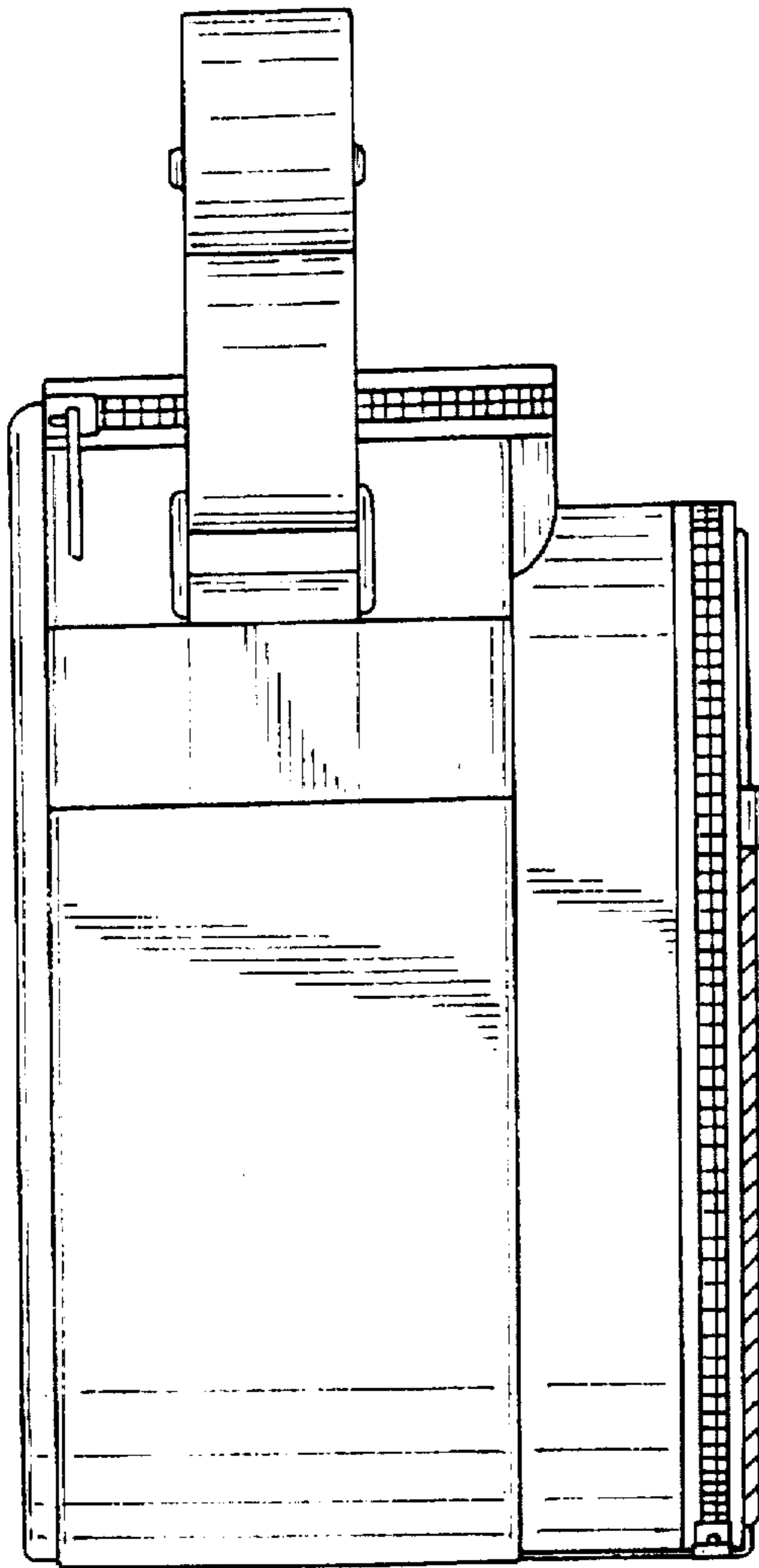

FIG. 13

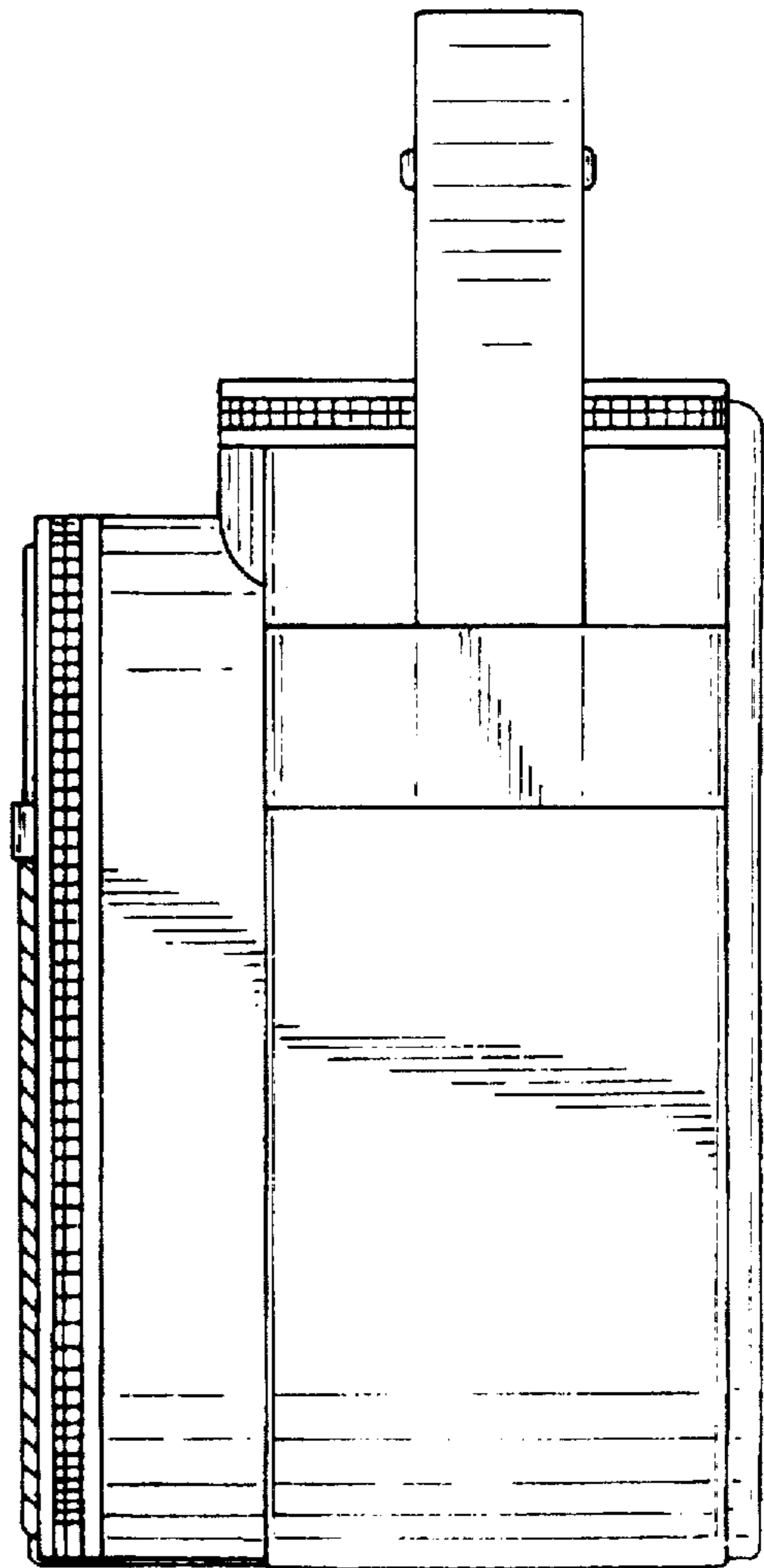

FIG. 14