



US00D394546S

# United States Patent [19]

[11] Patent Number: **Des. 394,546**

Svendsen et al.

[45] Date of Patent: **\*\*May 26, 1998**

[54] **INFANT FRAME CARRIER**

4,620,711	11/1986	Dick .....	224/153 X
4,718,715	1/1988	Ho .....	224/155 X
4,762,256	8/1988	Whitaker .....	224/155 X

[75] Inventors: **Sean W. Svendsen**, Columbus; **Paul Kolada**, Bexley; **David J. Stroud**, Dayton; **Steve Courtney**, Troy, all of Ohio

Primary Examiner—Prabhakar G. Deshmukh

[73] Assignee: **Lisco, Inc.**

[57] **CLAIM**

[\*\*] Term: **14 Years**

The ornamental design of the infant frame carrier, as shown and described.

[21] Appl. No.: **61,372**

**DESCRIPTION**

[22] Filed: **Oct. 16, 1996**

FIG. 1 is a perspective view of the infant frame carrier showing the design of our invention;  
 FIG. 2 is a front view thereof;  
 FIG. 3 is a right side view thereof;  
 FIG. 4 is a rear view thereof;  
 FIG. 5 is a top plan view thereof;  
 FIG. 6 is a bottom view thereof;  
 FIG. 7 is a perspective view of the infant frame carrier with the handle in the downward reclining position; and,  
 FIG. 8 is a perspective view of the infant frame carrier with the handle in the upward strolling position.  
 The left side view is a mirror image of the right side view.

[51] LOC (6) Cl. .... **03-99**

[52] U.S. Cl. .... **D3/214**

[58] Field of Search ..... **D3/213, 214, 216, D3/21; 224/153, 154, 155, 577, 578, 579, 161; D12/129**

[56] **References Cited**

**U.S. PATENT DOCUMENTS**

D. 365,925	1/1996	Roan .....	D3/214
D. 378,017	2/1997	Svendsen et al. ....	D3/214
2,346,989	4/1944	O'Brien .....	224/155

**1 Claim, 8 Drawing Sheets**

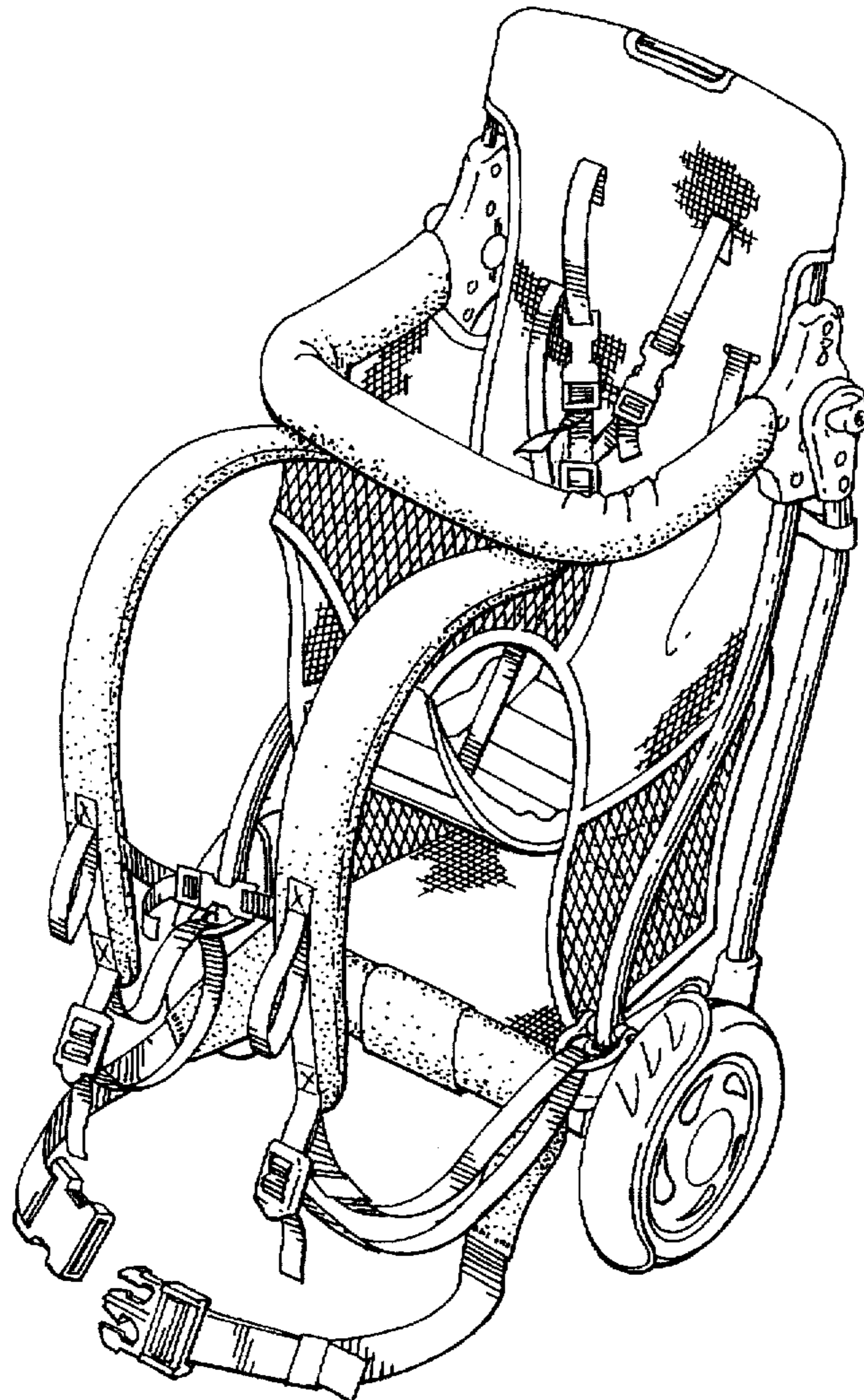

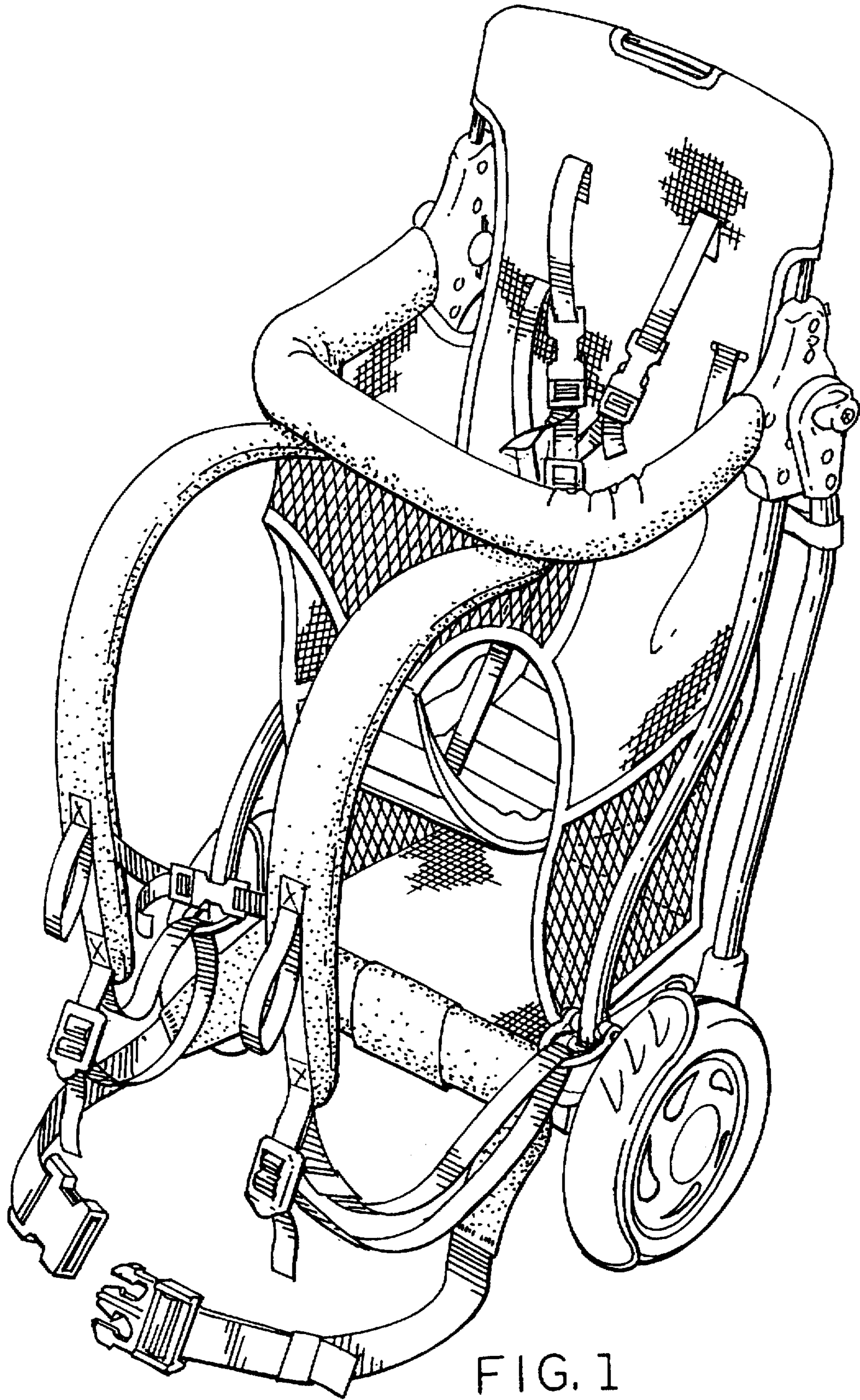

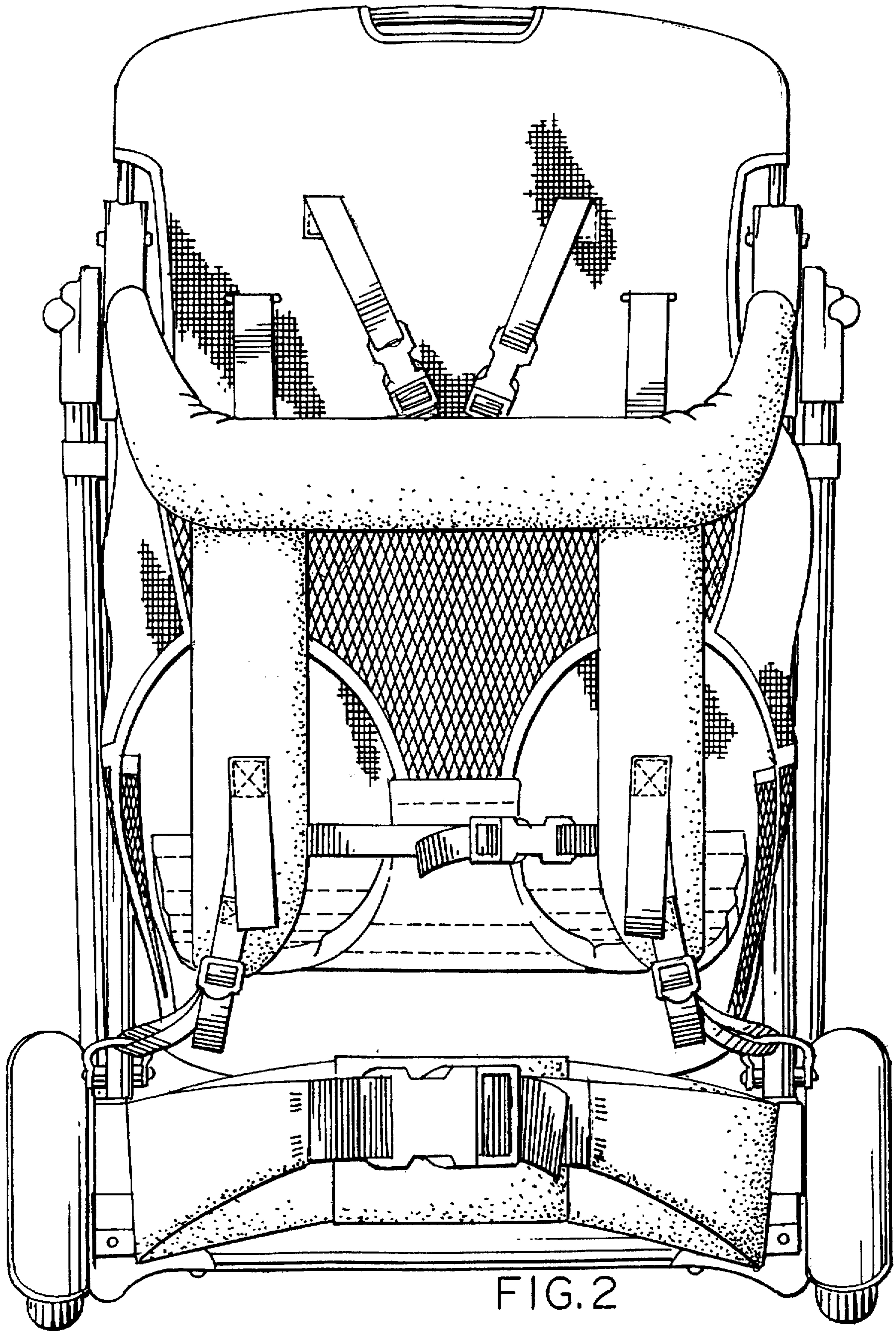

FIG. 2

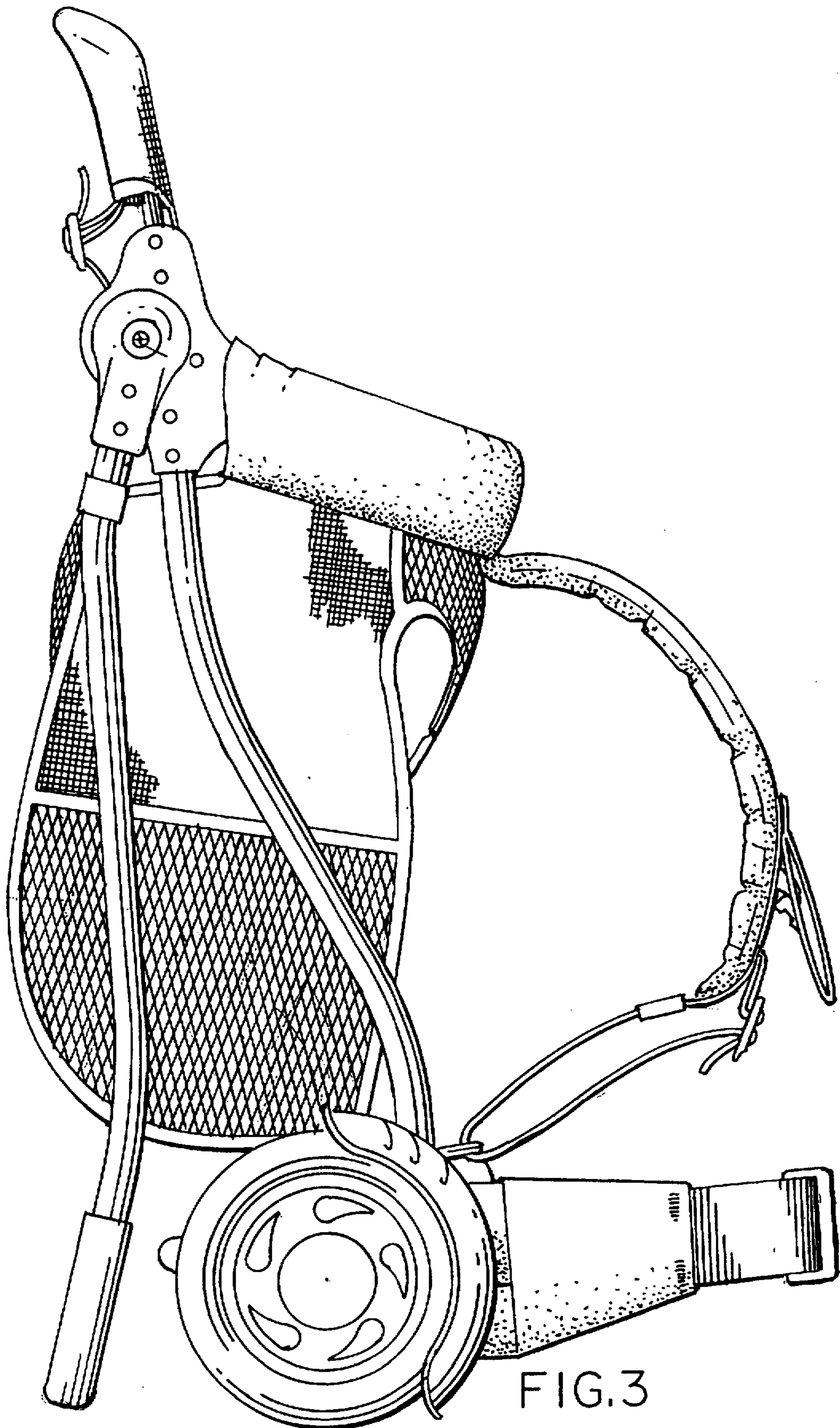

FIG. 3

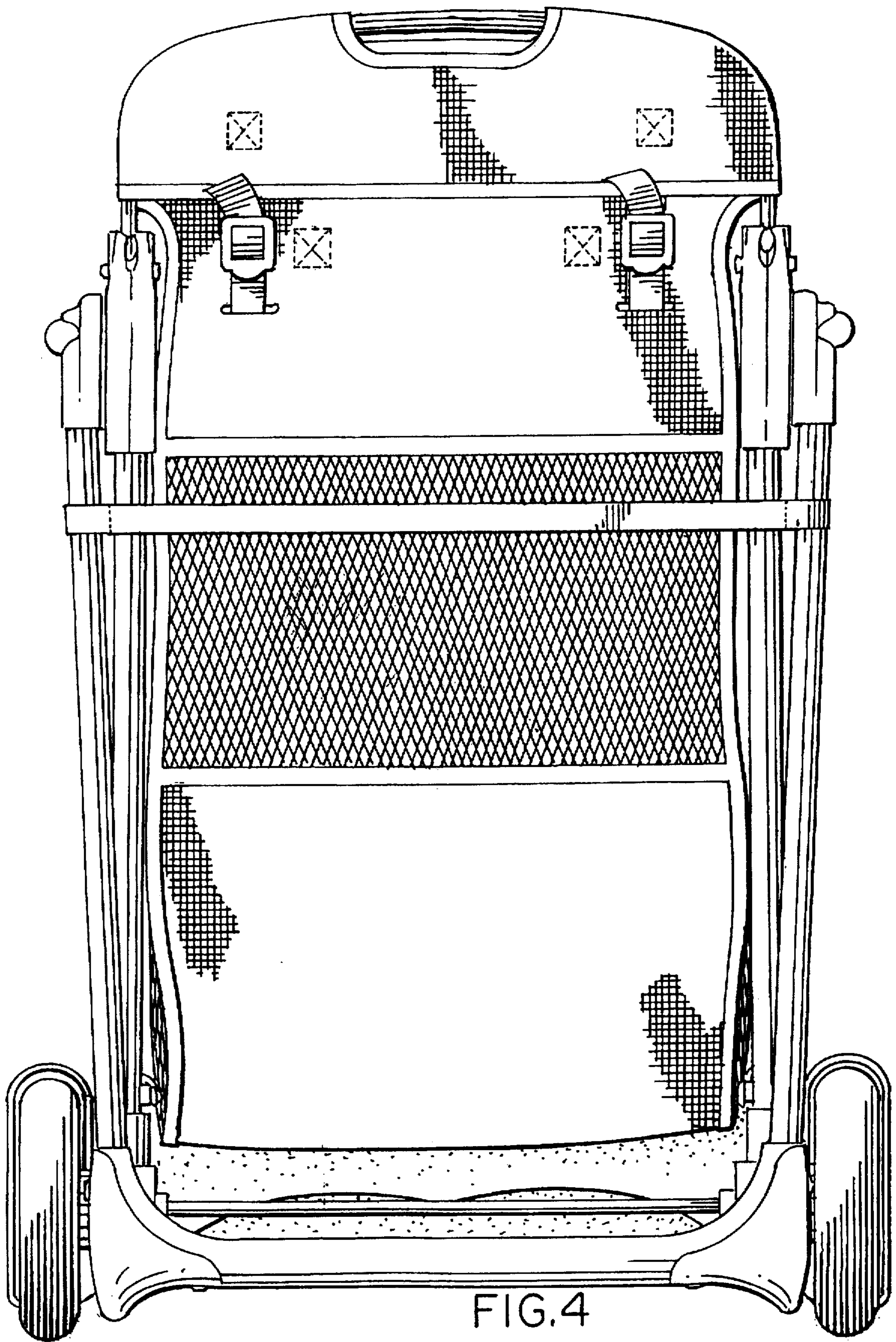

FIG. 4

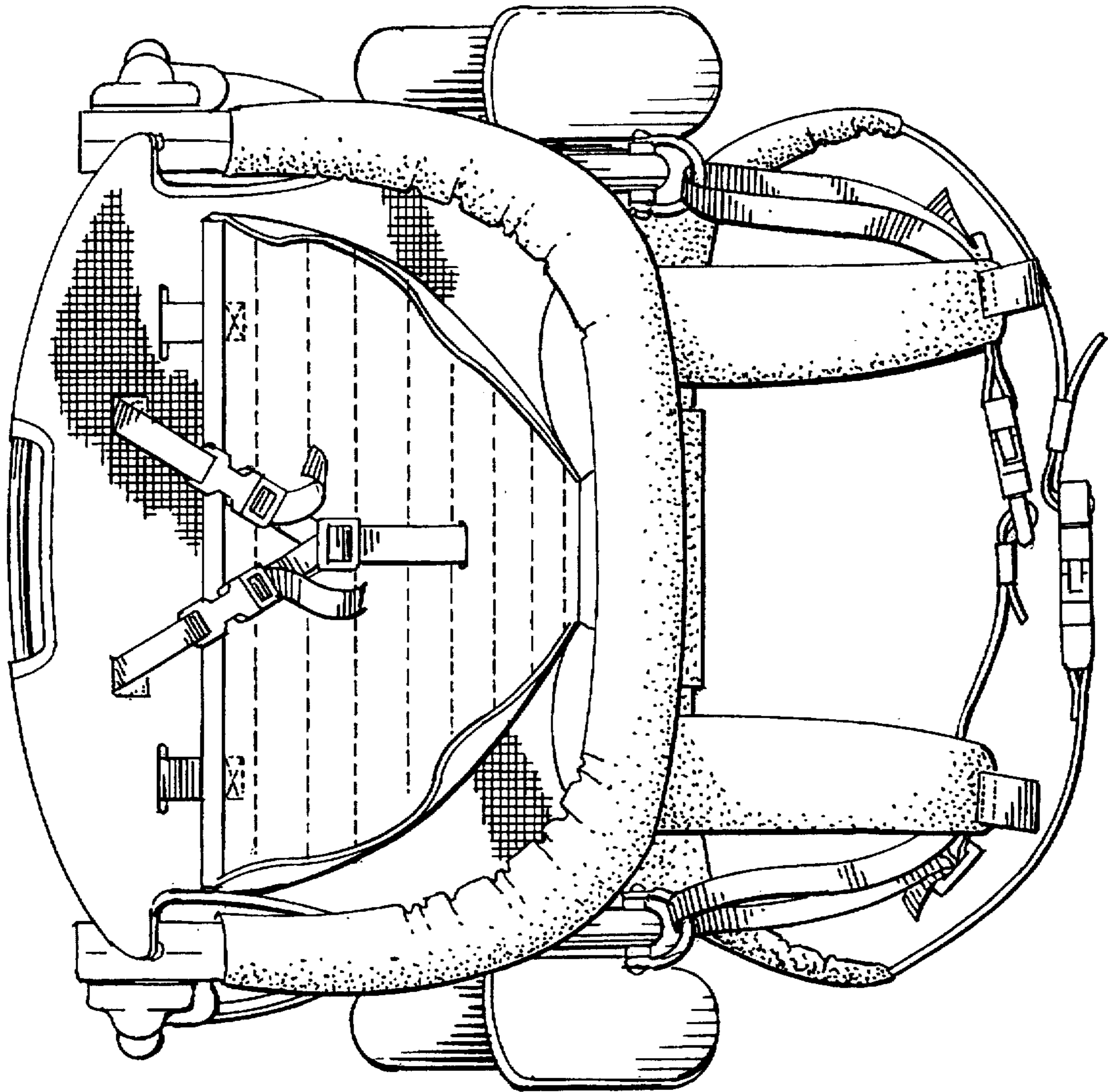

FIG. 5

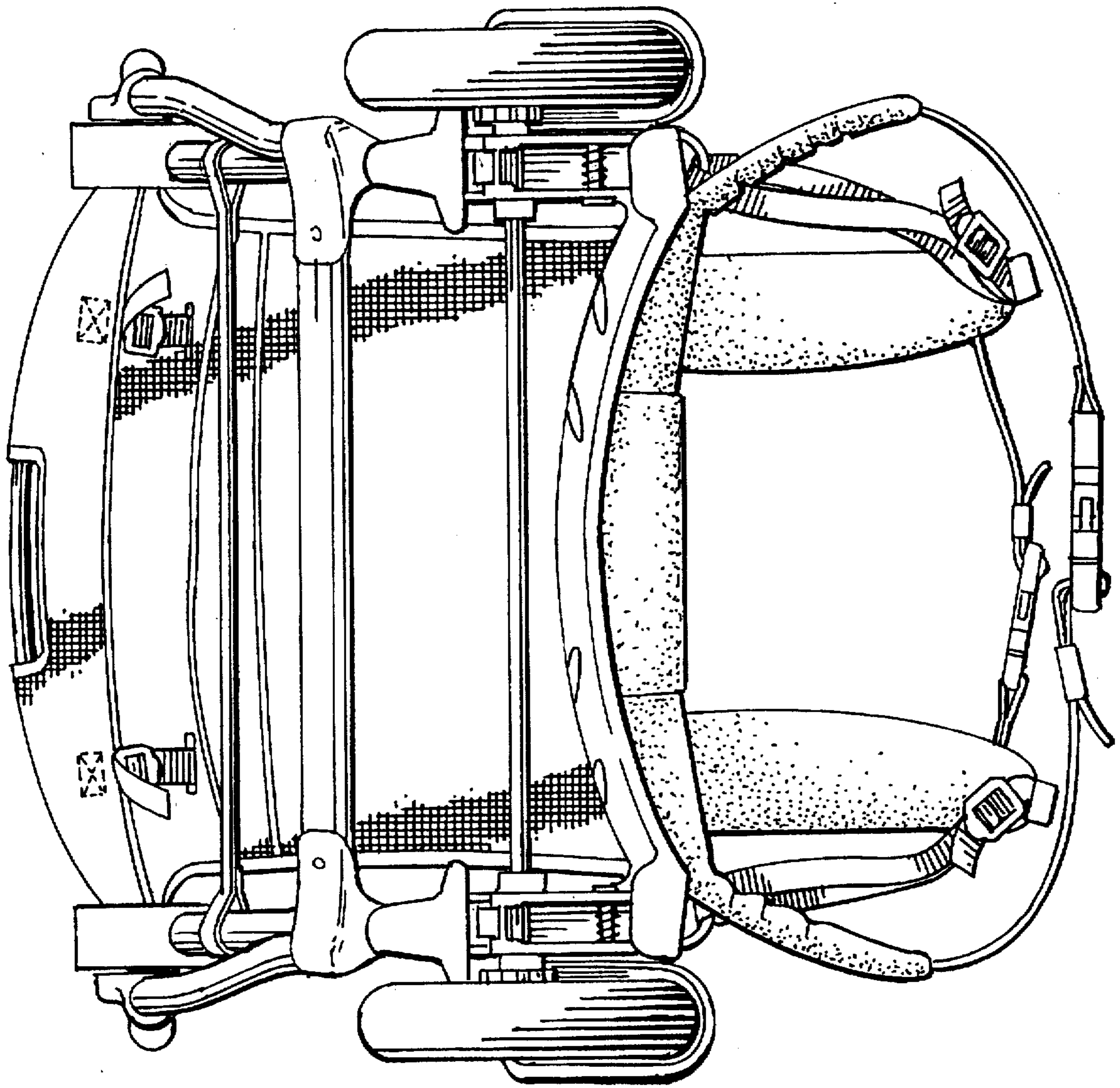

FIG.6

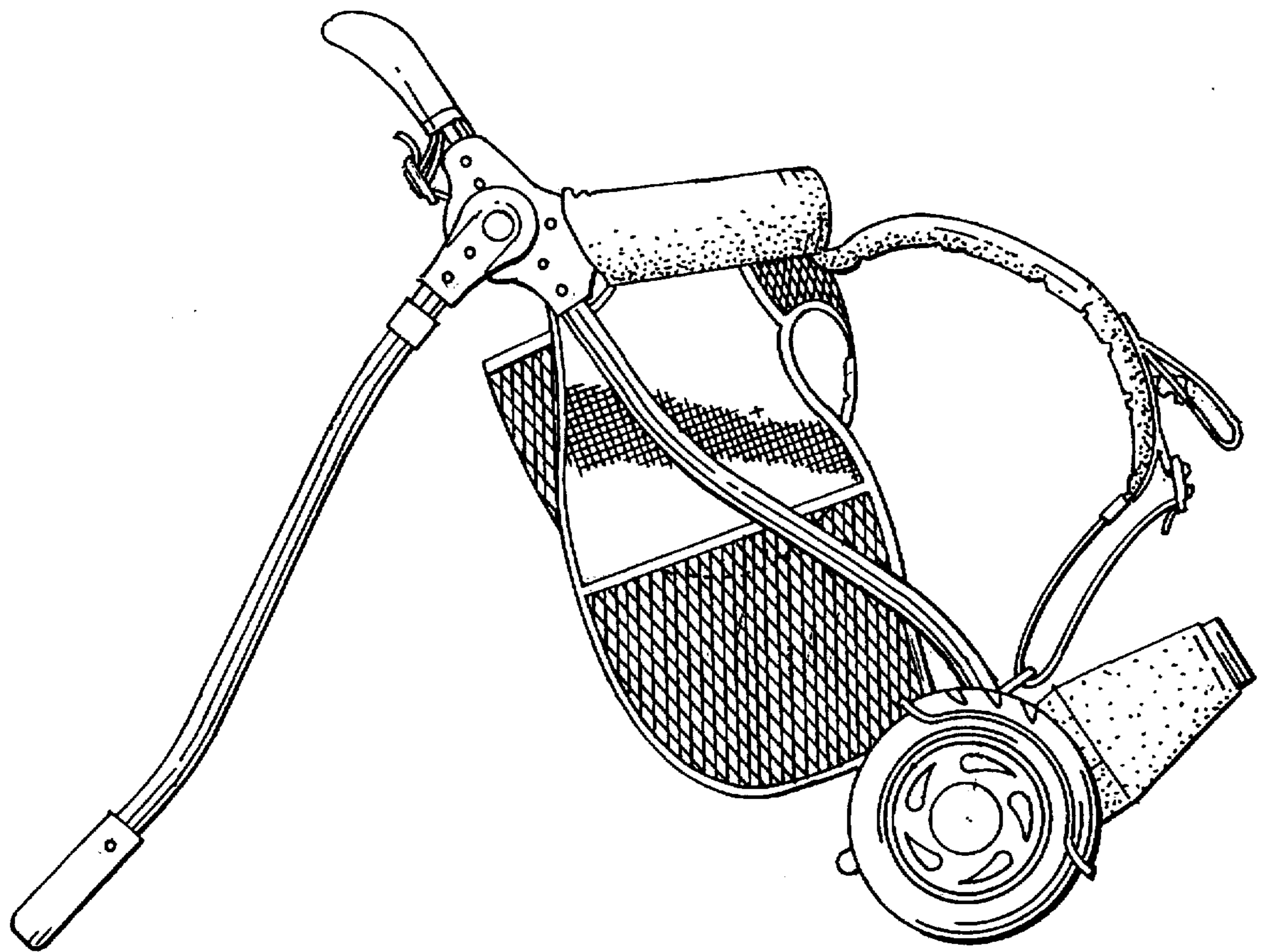

FIG. 7



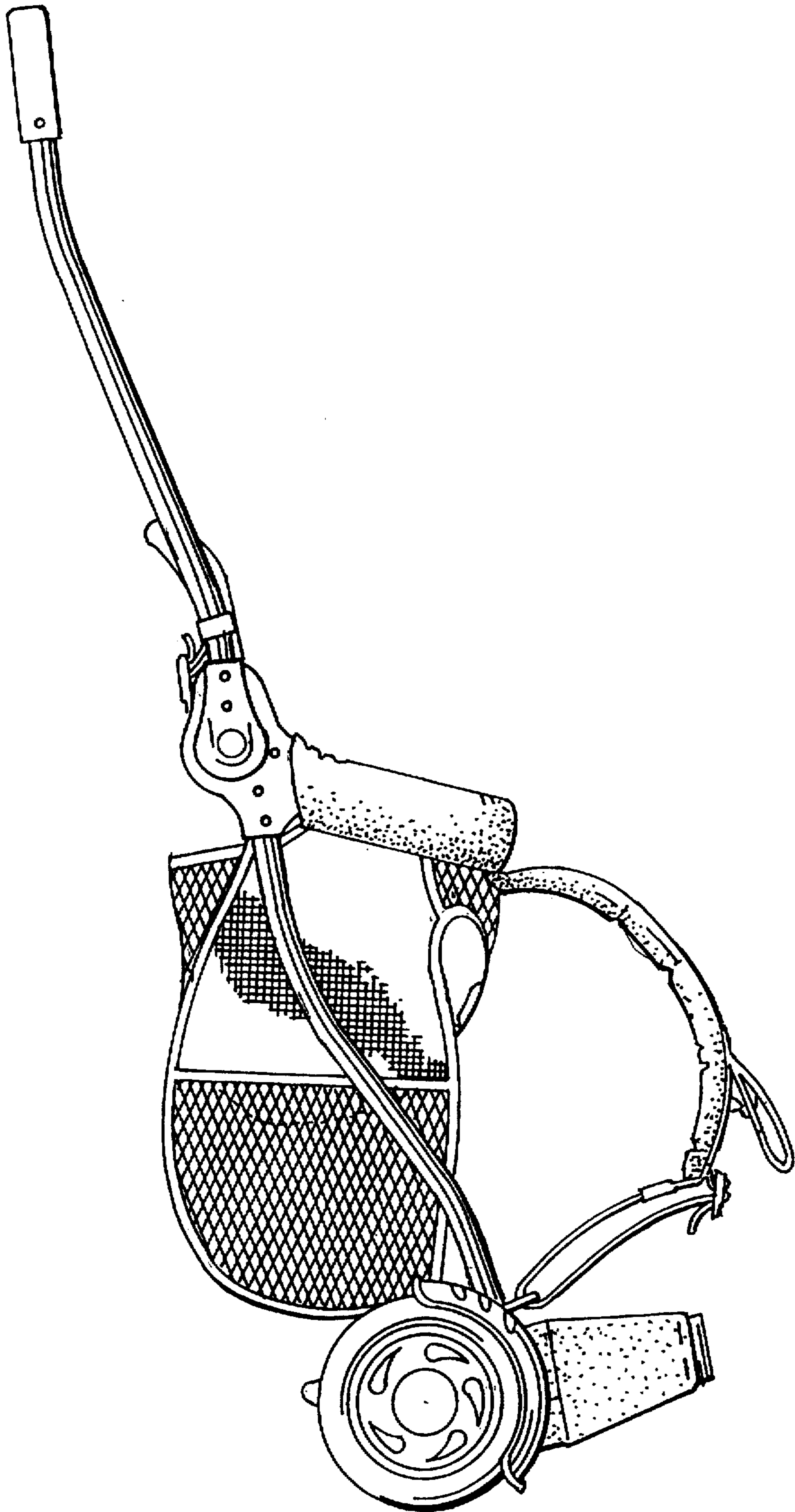

FIG. 8