



US00D394473S

United States Patent [19]
Michaelsen

[11] **Patent Number: Des. 394,473**

[45] **Date of Patent: **May 19, 1998**

[54] **TOY BUILDING ELEMENT**

D. 360,908 8/1995 Raszka D21/108
D. 372,504 8/1996 Jacobsen D21/108

[75] **Inventor: Carsten Michaelsen, Flegborg, Denmark**

Primary Examiner—Raphael Barkai
Attorney, Agent, or Firm—Kane, Dalsimer, Sullivan, Kurucz, Levy, Eisele and Richard, LLP

[73] **Assignee: INTERLEGO AG, Baar, Switzerland**

[**] **Term: 14 Years**

[57] **CLAIM**

[21] **Appl. No.: 76,930**

The ornamental design for a toy building element, as shown and described.

[22] **Filed: Sep. 18, 1997**

DESCRIPTION

[51] **LOC (6) Cl. 21-01**

[52] **U.S. Cl. D21/108**

[58] **Field of Search D21/108, 109, D21/114; 446/104, 110, 120, 121, 124, 125, 128, 476, 479**

FIG. 1 is a top perspective view of the toy building element; FIG. 2 is a bottom perspective view thereof; FIG. 3 is a front elevational view thereof; FIG. 4 is a right side elevational view thereof; FIG. 5 is a left side elevational view thereof; FIG. 6 is a rear elevational view thereof; FIG. 7 is a bottom plan view thereof; and, FIG. 8 is a top plan view thereof.

[56] **References Cited**

U.S. PATENT DOCUMENTS

D. 351,006 9/1994 Nielsen et al. .
D. 352,747 11/1994 Lijlund et al. D21/108

1 Claim, 3 Drawing Sheets

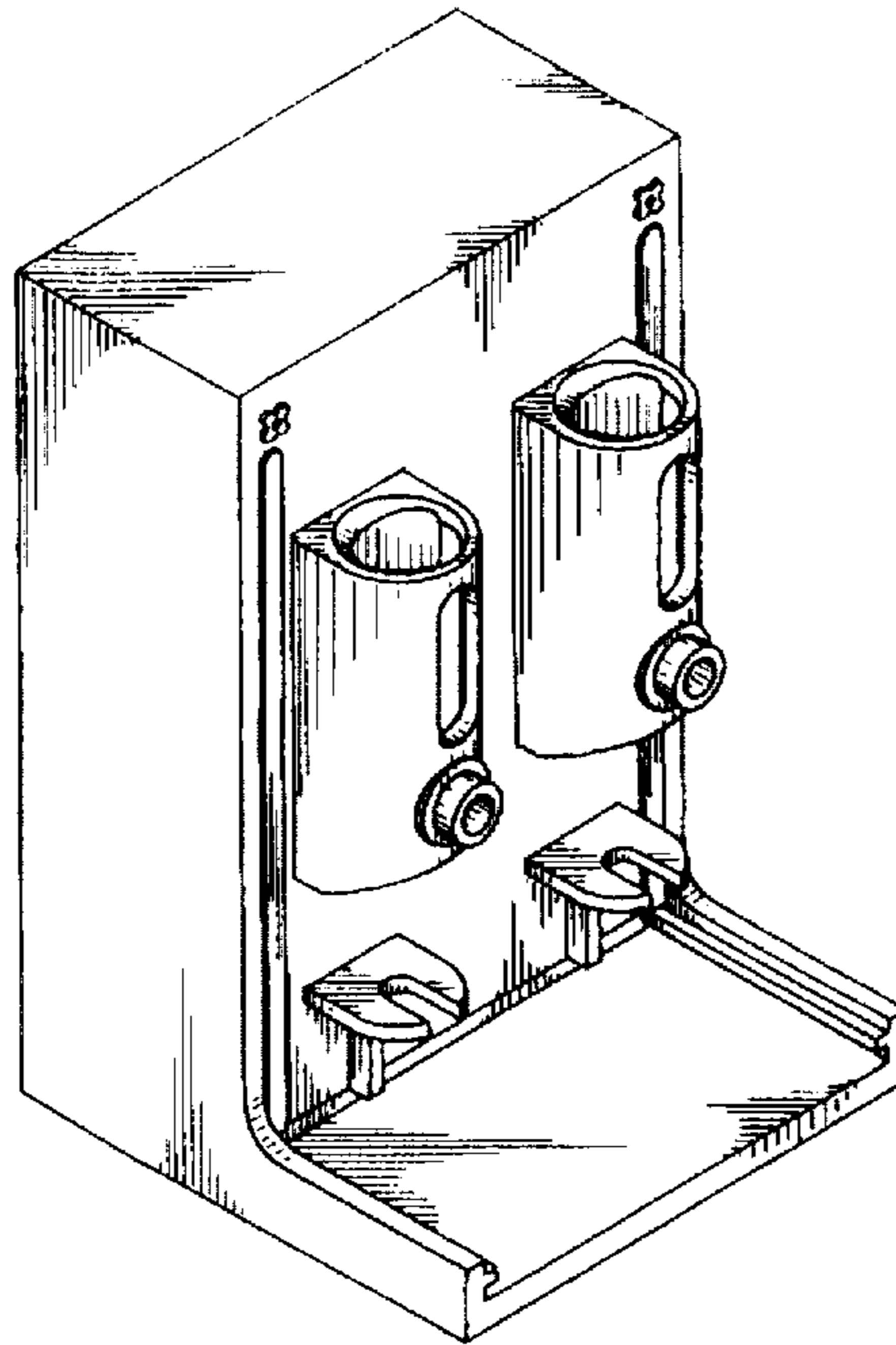

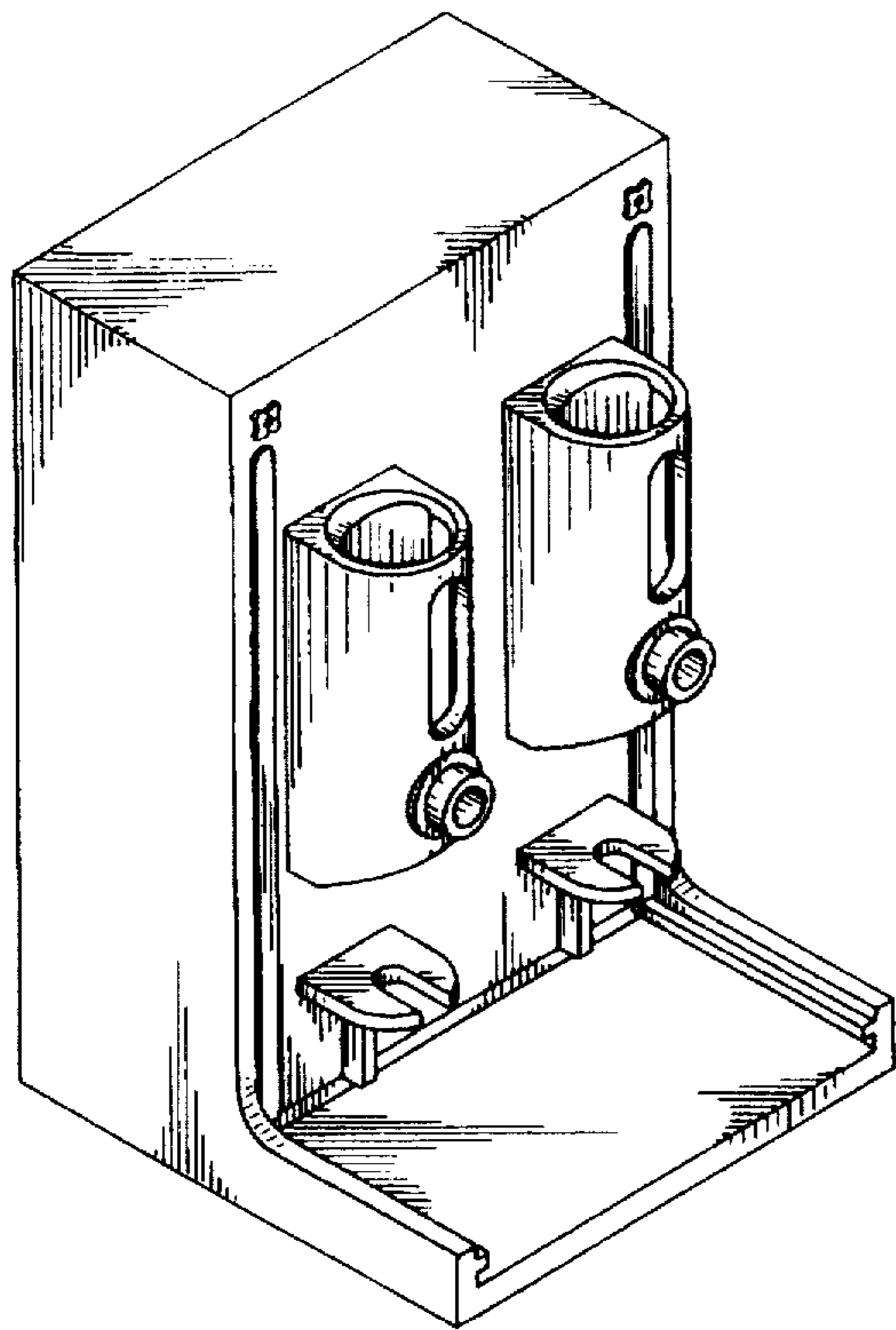

Fig. 1

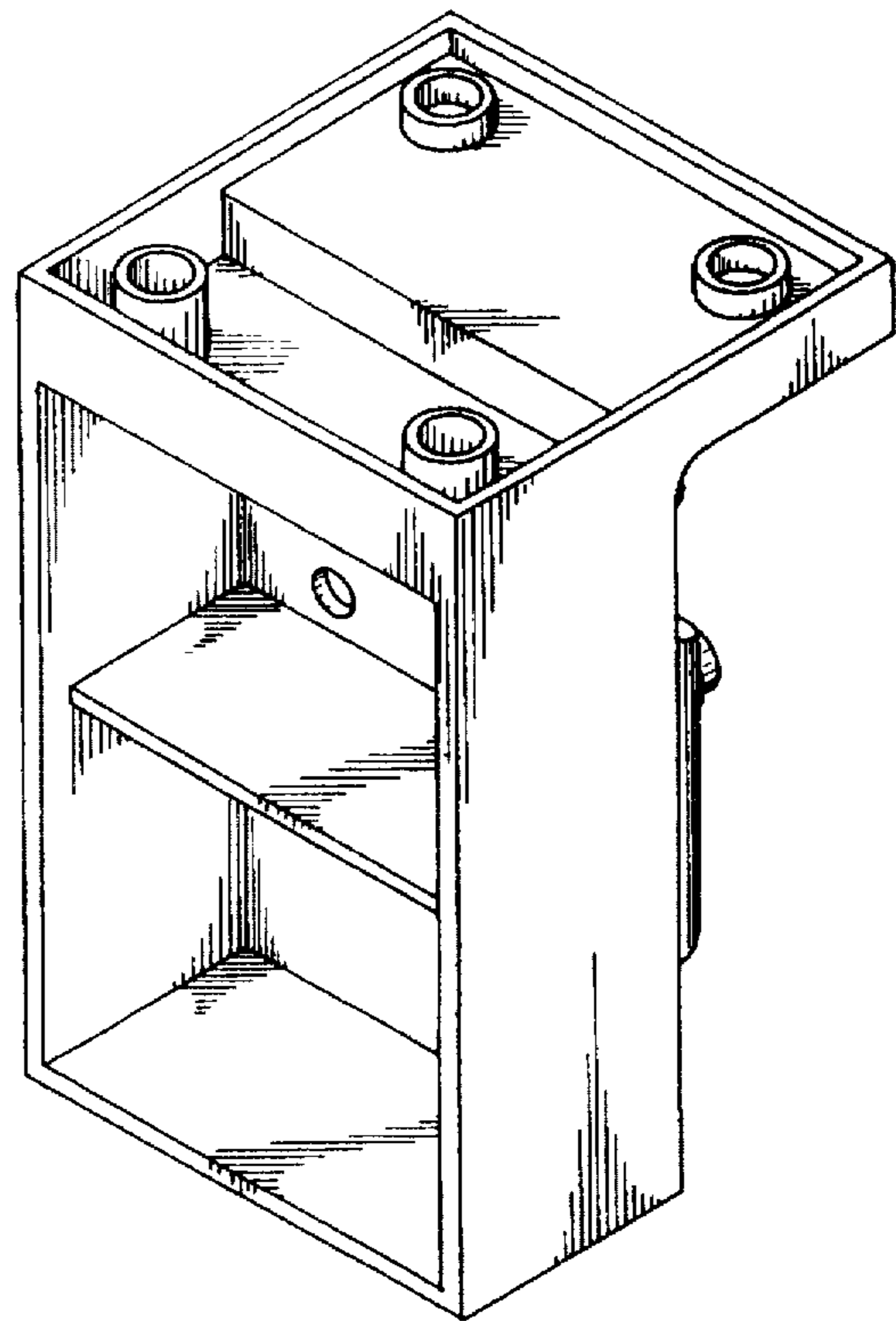

Fig. 2

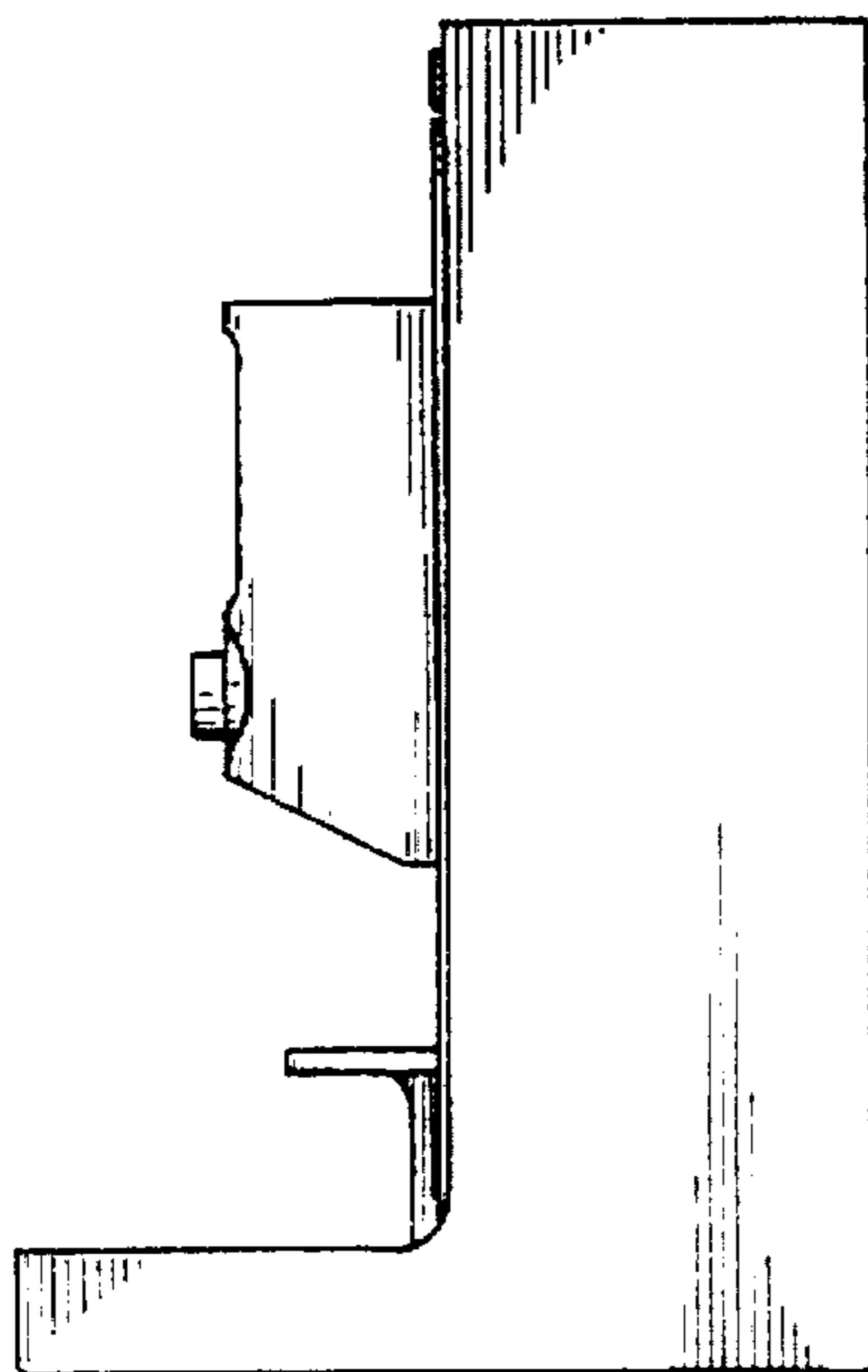

Fig. 4

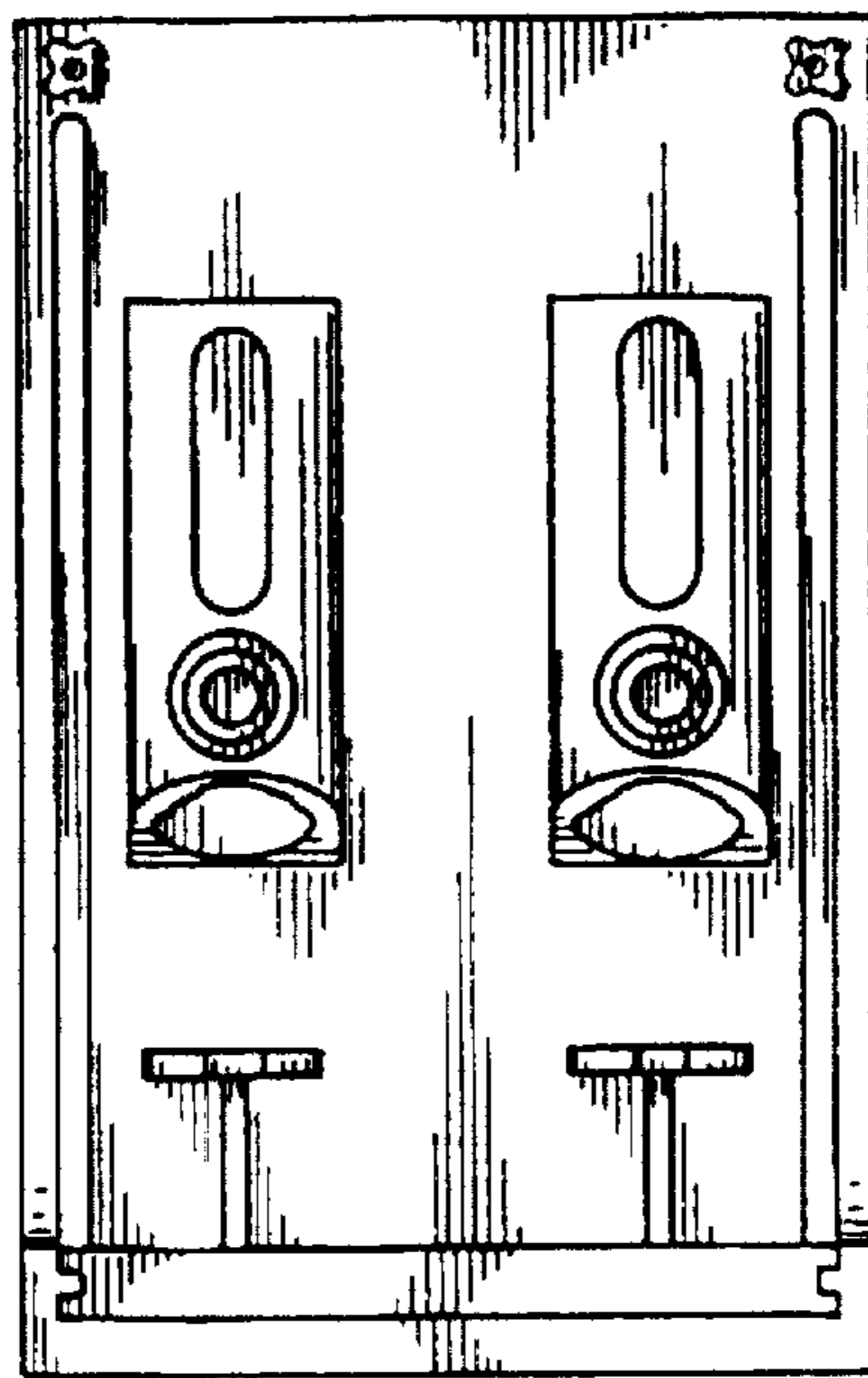

Fig. 3

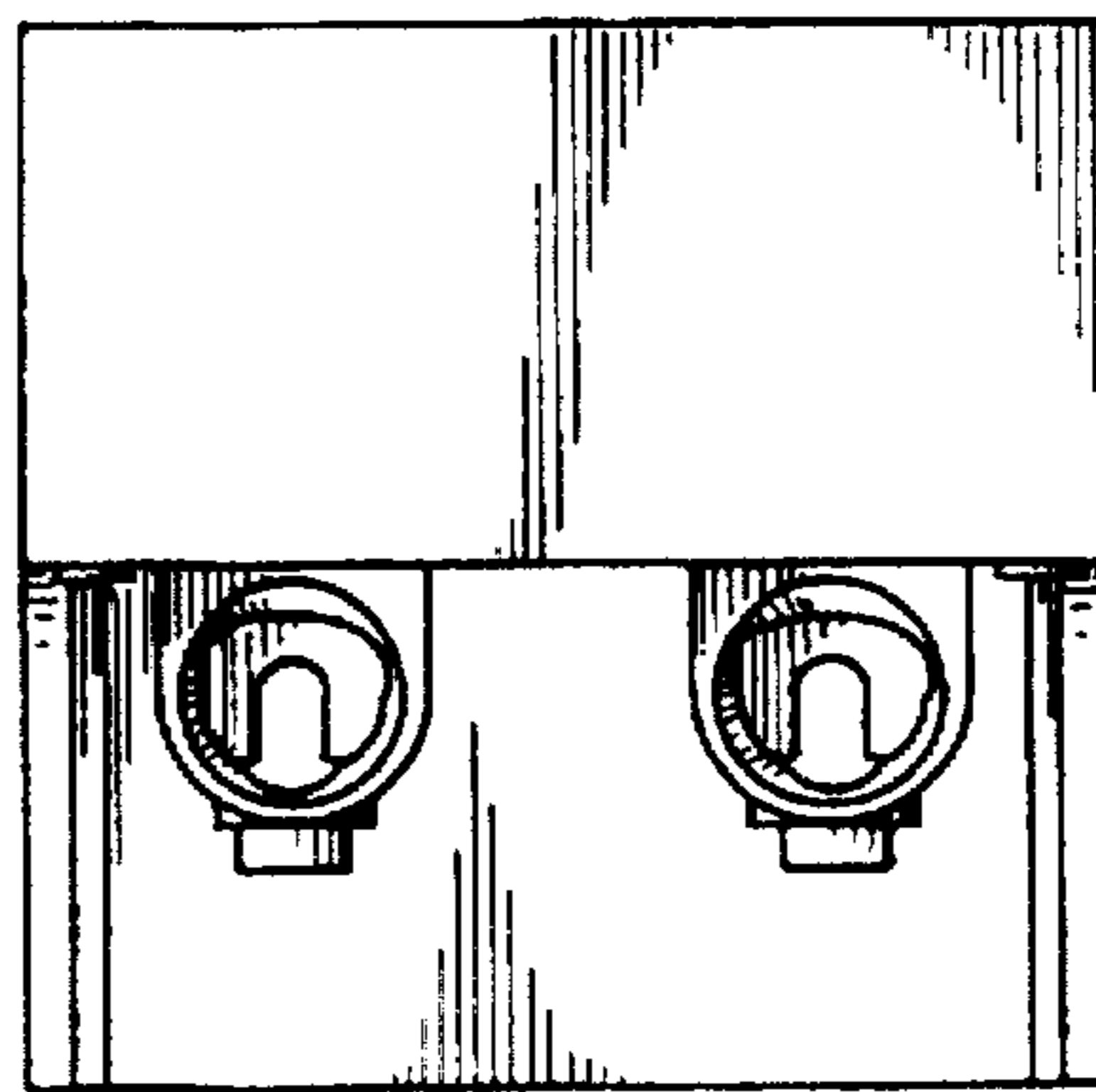

Fig. 8

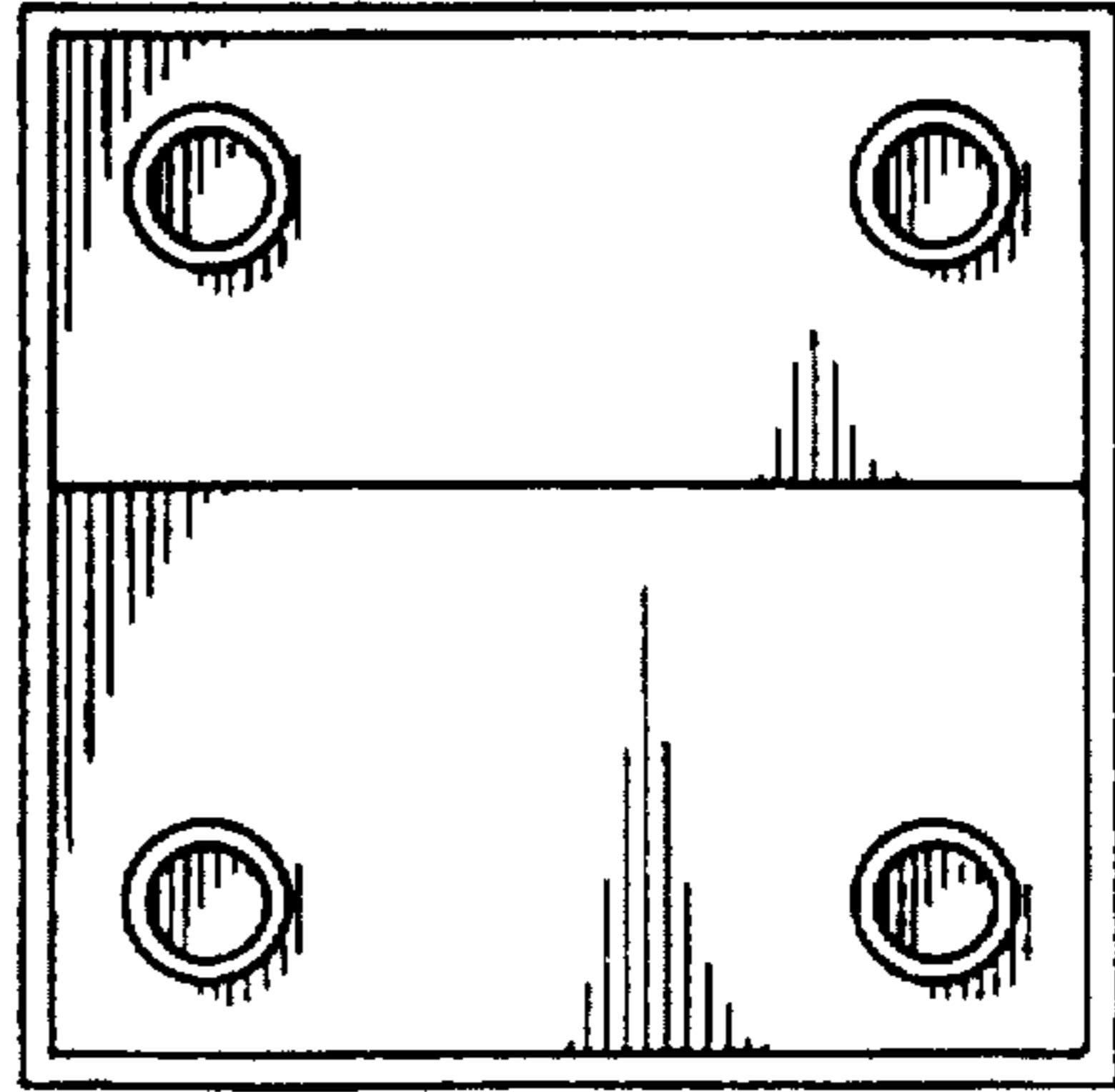

Fig. 7

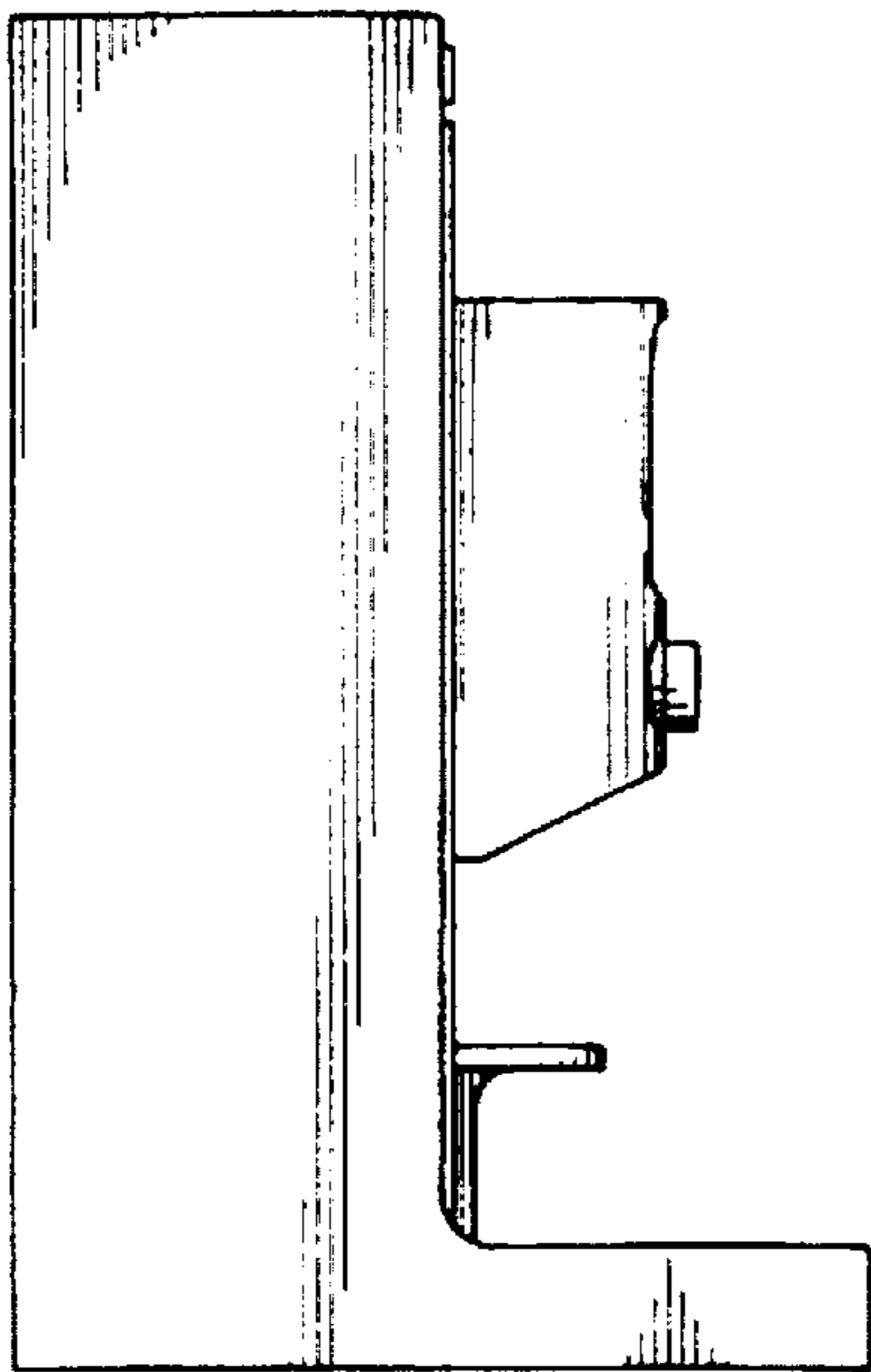

Fig. 5

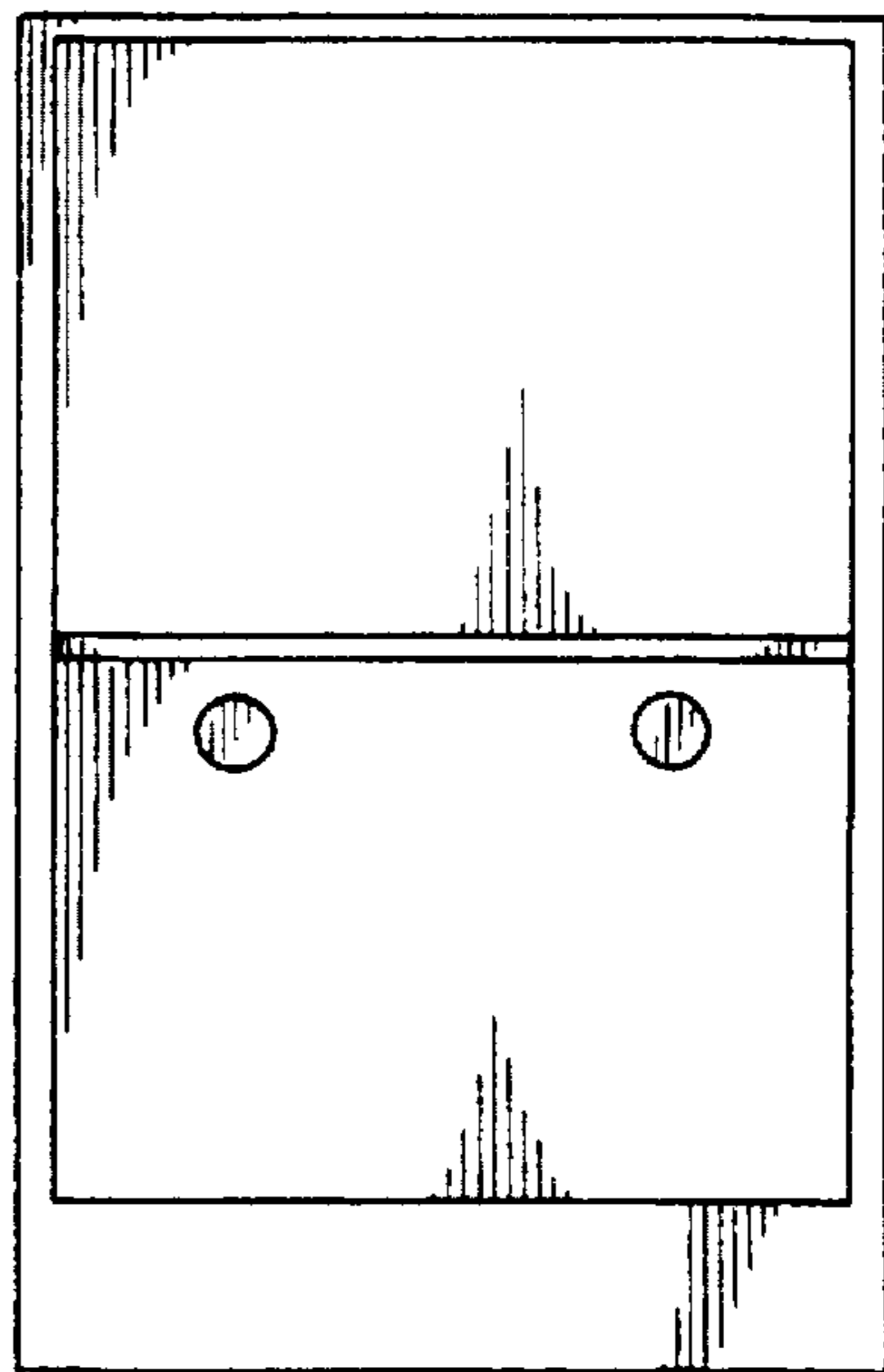

Fig. 6

UNITED STATES PATENT AND TRADEMARK OFFICE
CERTIFICATE OF CORRECTION

PATENT NO. : Des. 394,473
DATED : May 19, 1998
INVENTOR(S) : Carsten Michaelsen

It is certified that error appears in the above-identified patent and that said Letters Patent is hereby corrected as shown below:

On the title page, Item [75], correct the inventor information to read as follows:

[75] Inventor: Carsten Michaelsen, Vejle,
Denmark

Signed and Sealed this
Eleventh Day of August 1998



Attest:

BRUCE LEHMAN

Attesting Officer

Commissioner of Patents and Trademarks