

US00D394443S

United States Patent [19]

[11] Patent Number: **Des. 394,443**

Hayashi et al.

[45] Date of Patent: ****May 19, 1998**

[54] **COMBINED MONITOR SCREEN DIGITAL DISK RECORDER AND ELECTRONIC STILL CAMERA**

D. 372,925	8/1996	Choi	D16/202
D. 380,226	6/1997	Ohi et al.	D16/202
D. 384,963	10/1997	Sekita	D16/202
D. 387,078	12/1997	Akita	D16/218
4,873,576	10/1989	Hattori et al.	348/373

[75] Inventors: **Ryozo Hayashi; Masao Shimazu; Hirokazu Shibata; Daijiro Tokunaga; Yasuhiko Miyoshi**, all of Hiroshima-ken, Japan

FOREIGN PATENT DOCUMENTS

8-205014 8/1996 Japan H04N 5/225

[73] Assignee: **Sharp Kabushiki Kaisha**, Osaka, Japan

OTHER PUBLICATIONS

[**] Term: **14 Years**

Sony Catalog, cover page, Feb. 1994.

[21] Appl. No.: **67,168**

Primary Examiner—Sandra L. Morris

Assistant Examiner—Adir Aronovich

[22] Filed: **Mar. 4, 1997**

Attorney, Agent, or Firm—Nixon & Vanderhye

[30] Foreign Application Priority Data

Sep. 4, 1996	[JP]	Japan	8-26595
Nov. 21, 1996	[JP]	Japan	8-35538

[57] CLAIM

[51] LOC (6) Cl. **16-01**

[52] U.S. Cl. **D16/208; D16/202; D16/218**

[58] Field of Search D16/200–205, D16/208, 216, 217, 218; 348/373–376; 358/906, 909.1; 396/535–543; H04N 5/225

The ornamental design for a “combined monitor screen, digital disk recorder and electronic still camera”, as shown and described.

DESCRIPTION

[56] References Cited

U.S. PATENT DOCUMENTS

D. 352,728	11/1994	Kurokawa et al.	D16/202
D. 352,729	11/1994	Tsujimura et al.	D16/202
D. 356,097	3/1995	Sakata et al.	D16/202
D. 365,116	12/1995	Ohi et al.	D16/202
D. 366,269	1/1996	Ohi et al.	D16/202
D. 371,377	7/1996	Miyahara	D16/202

FIG. 1 is a top, left side and front perspective view of a combined monitor screen, digital disk recorder and electronic still camera according to our design;
 FIG. 2 is a top, right side and rear perspective view thereof;
 FIG. 3 is a top plan view thereof;
 FIG. 4 is a bottom plan view thereof;
 FIG. 5 is a rear elevational view thereof;
 FIG. 6 is a front elevational view thereof;
 FIG. 7 is a left side elevational view thereof; and,
 FIG. 8 is a right side elevational view thereof.

1 Claim, 6 Drawing Sheets

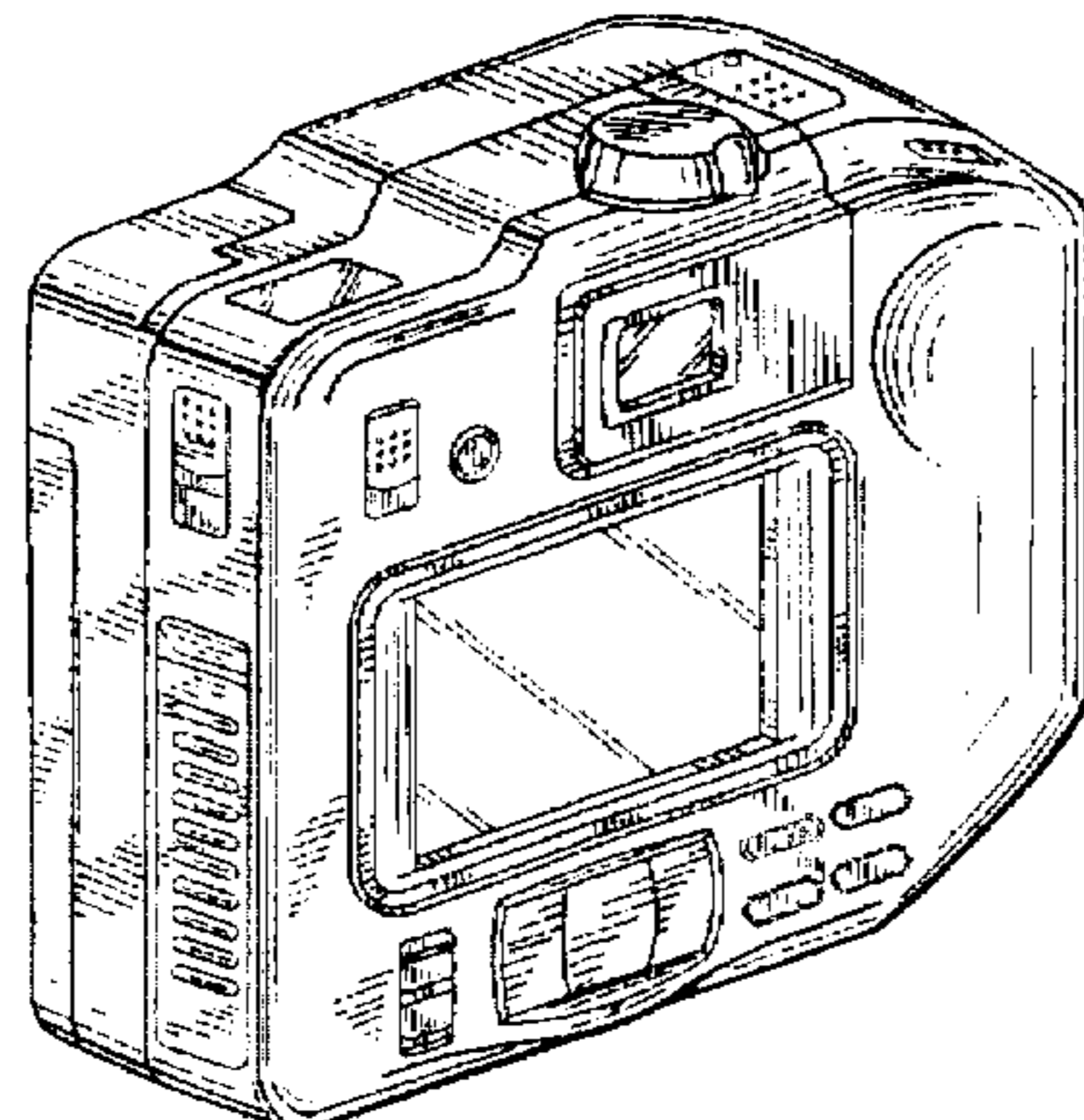
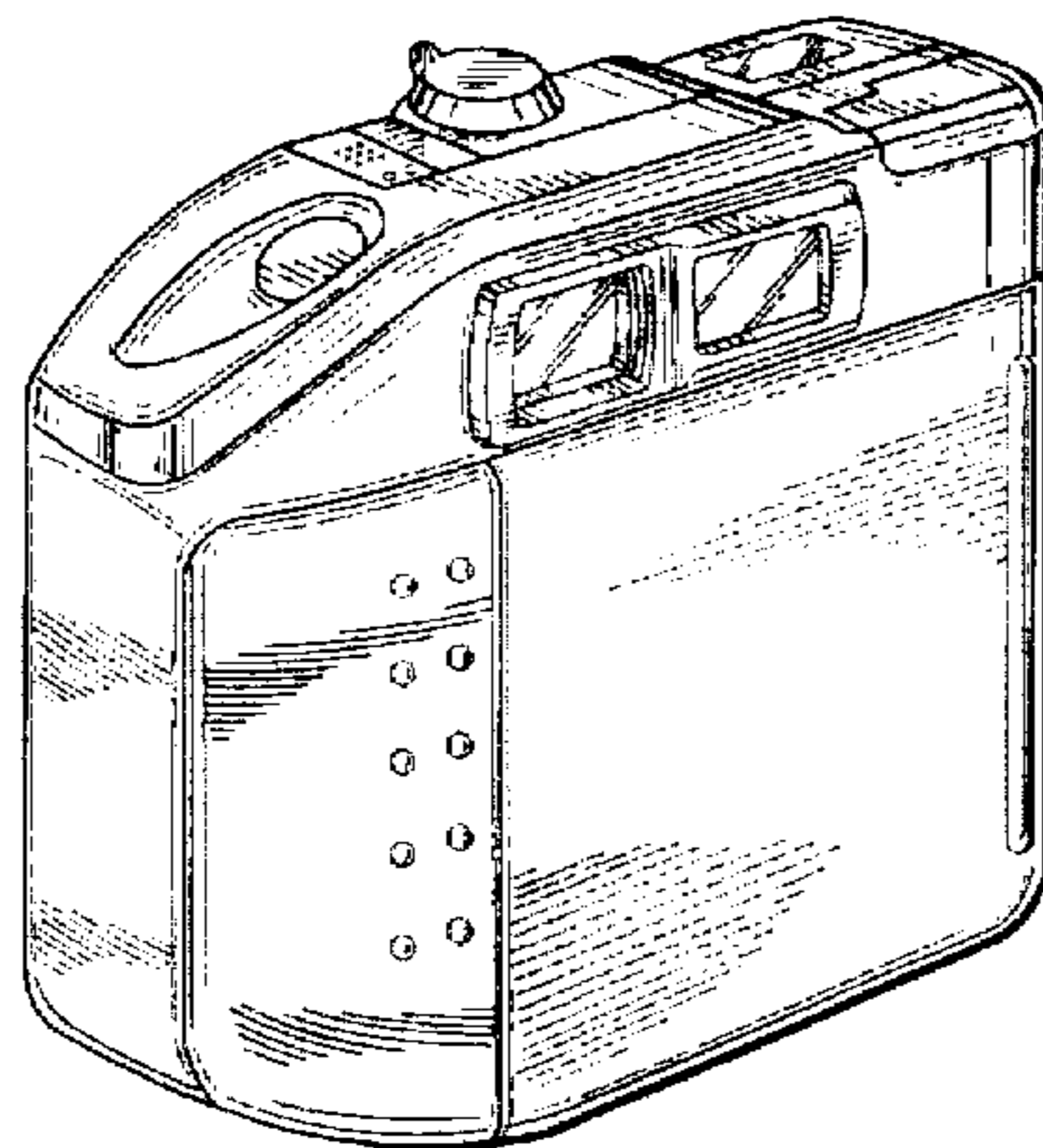

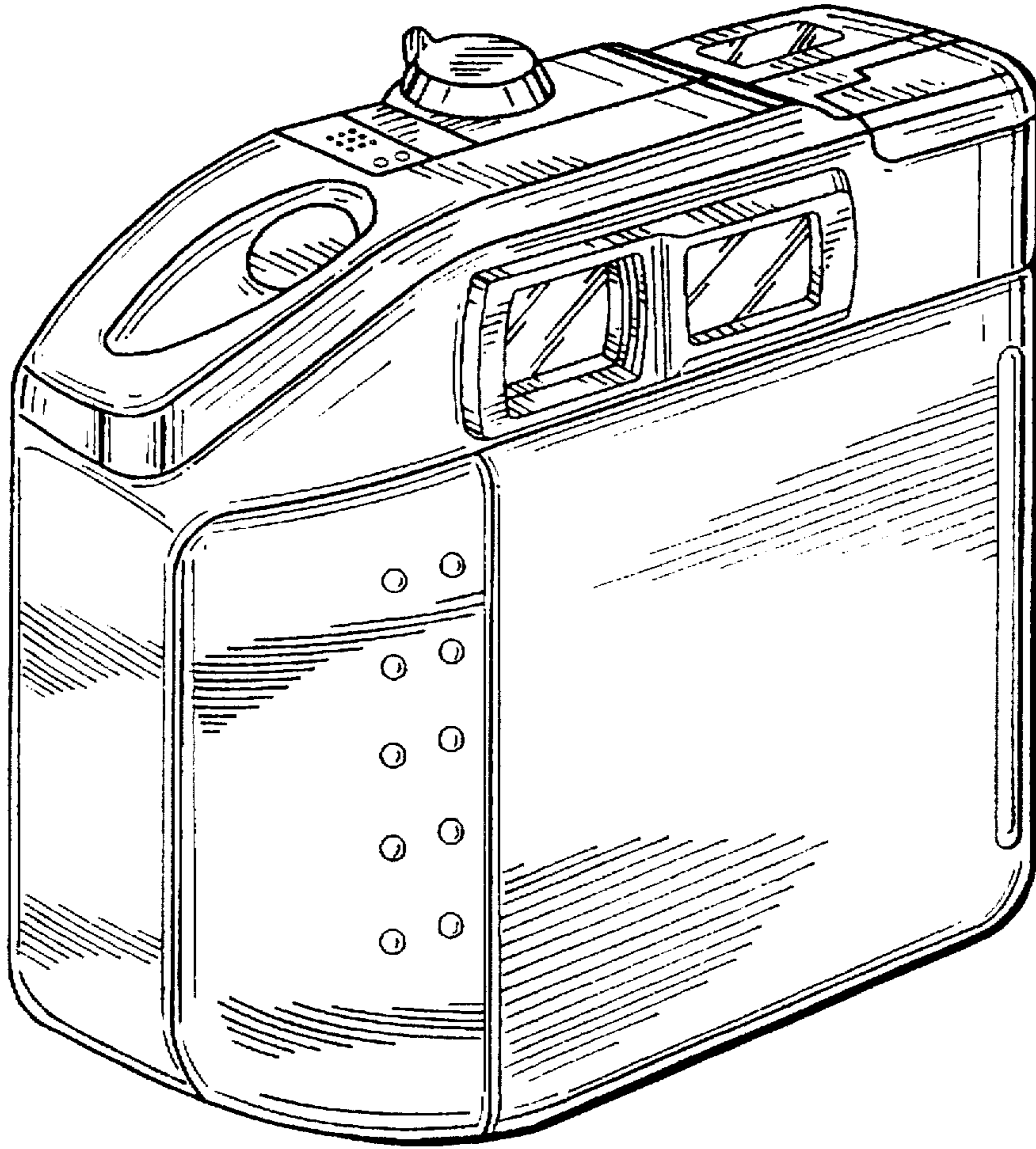

FIG. 1

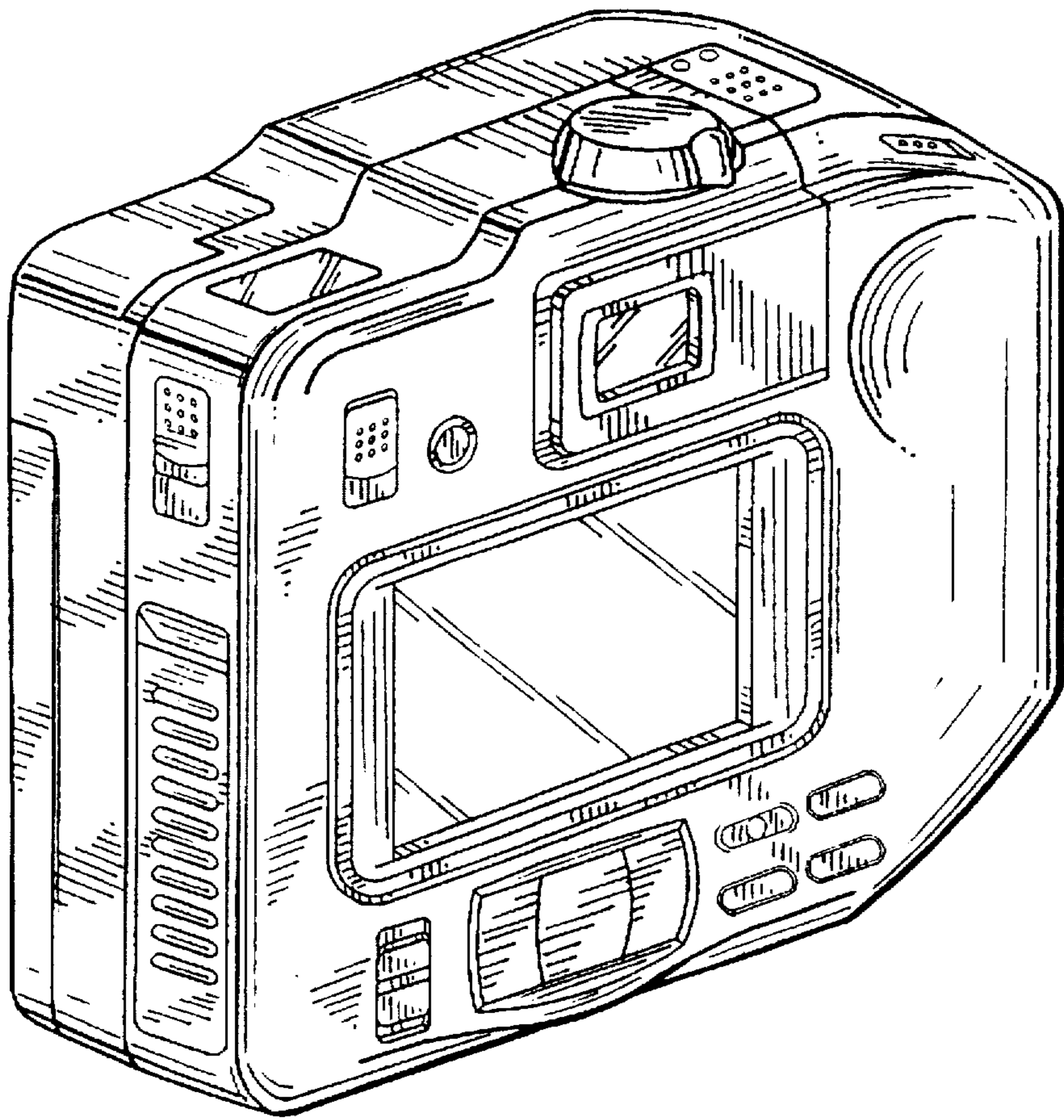

FIG. 2

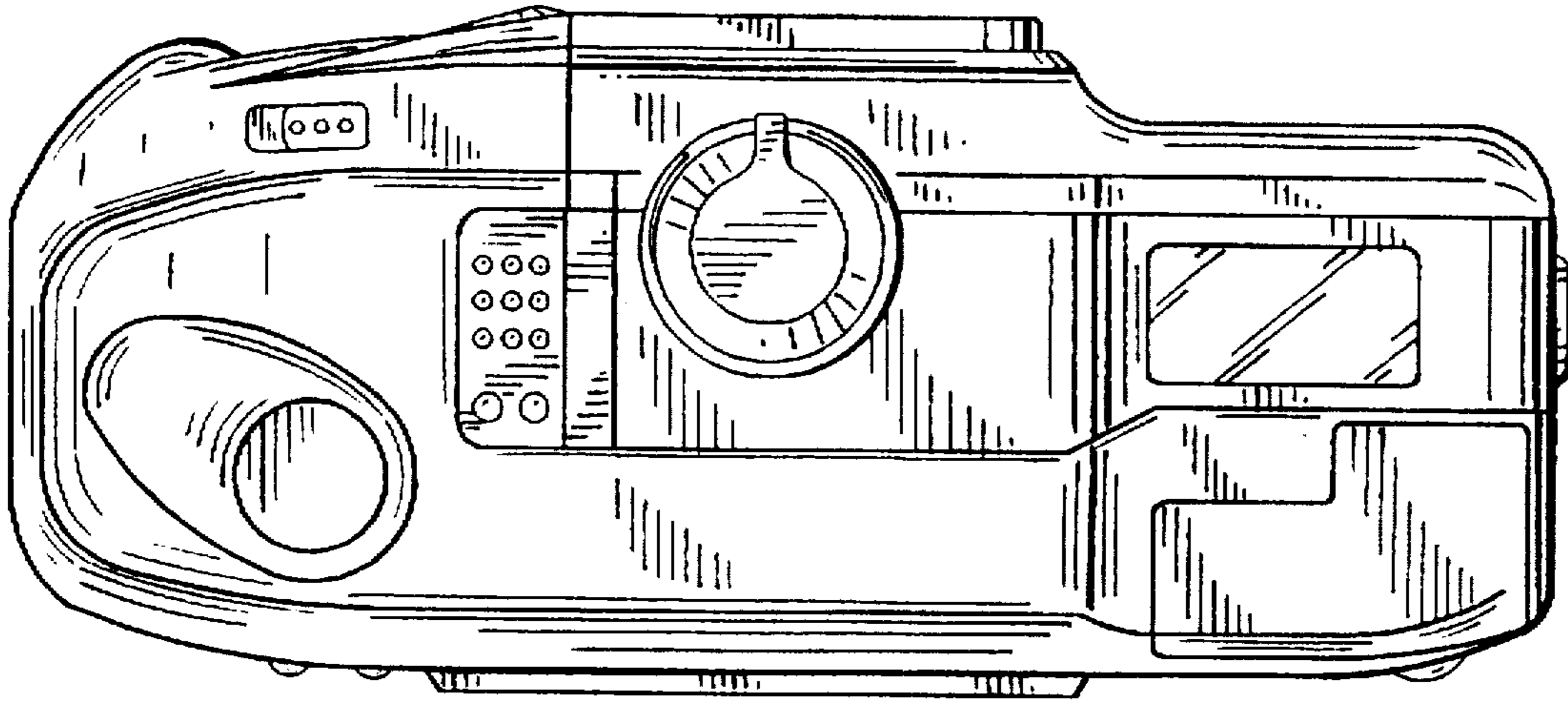

FIG. 3

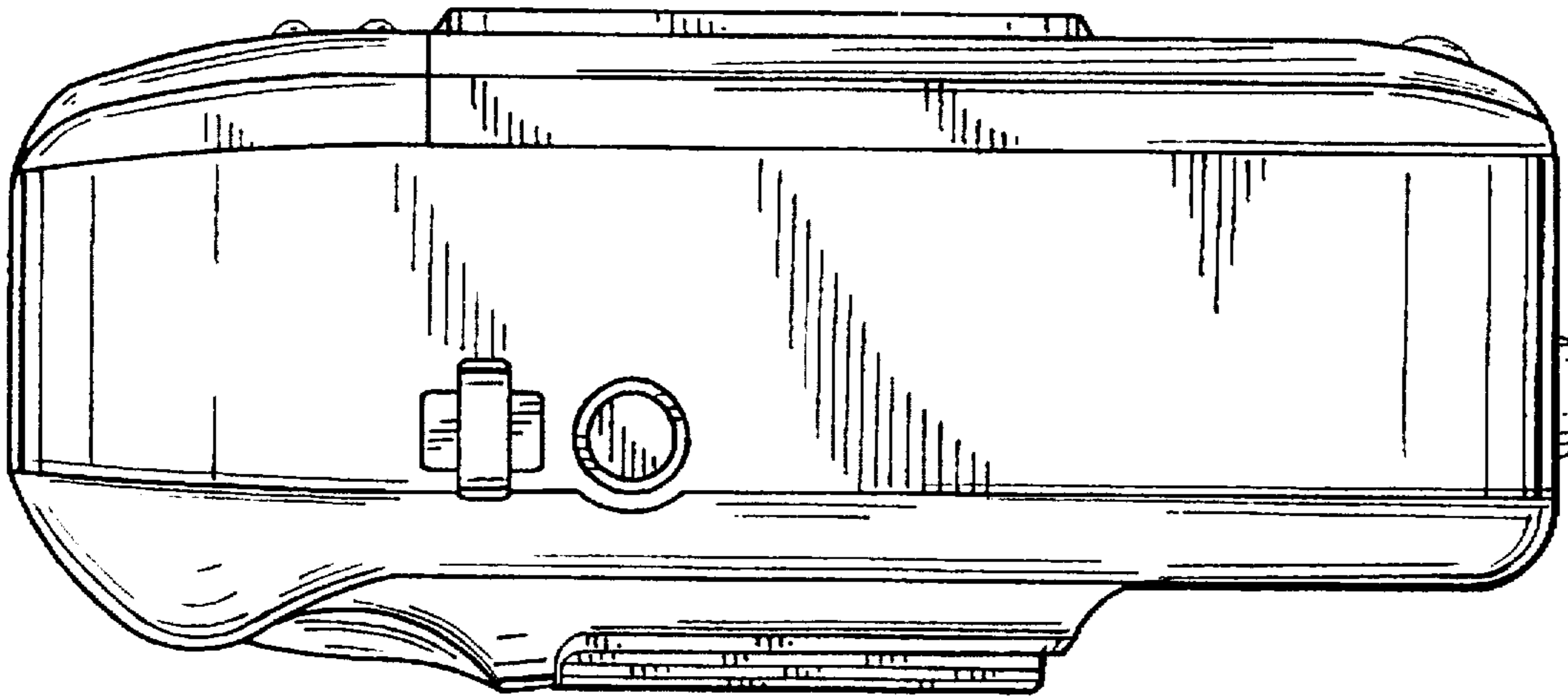

FIG. 4

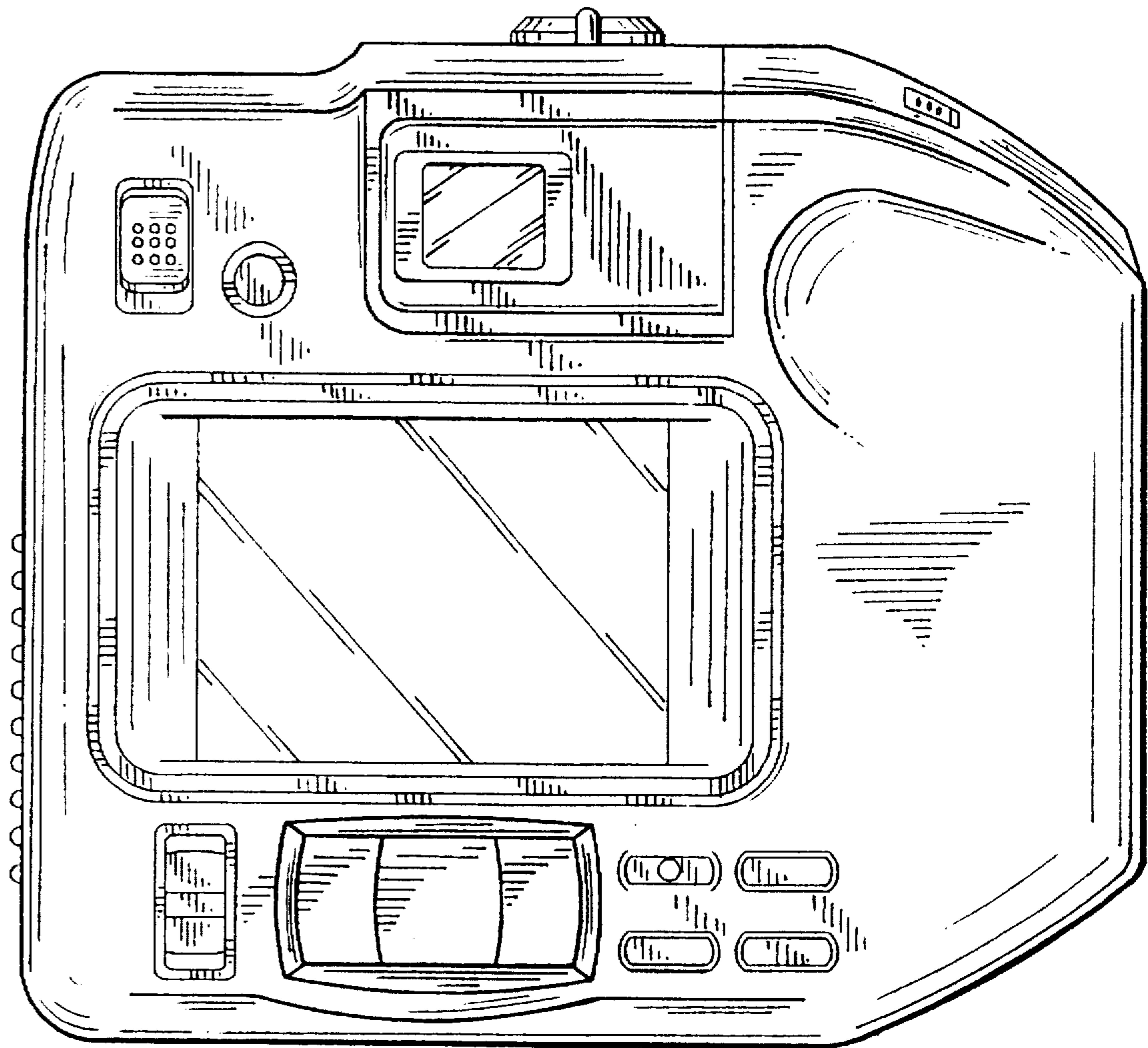

FIG. 5

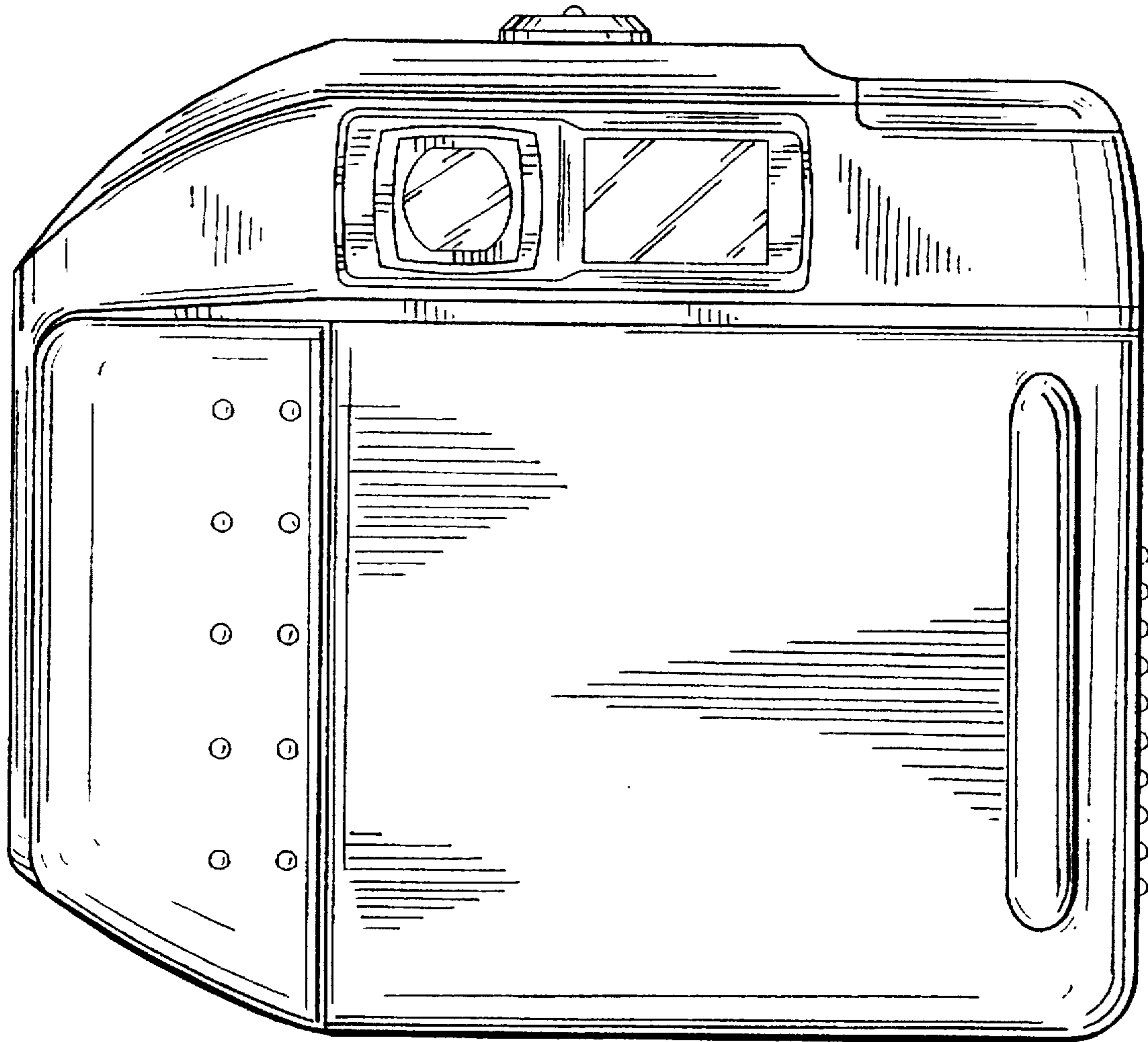

FIG. 6

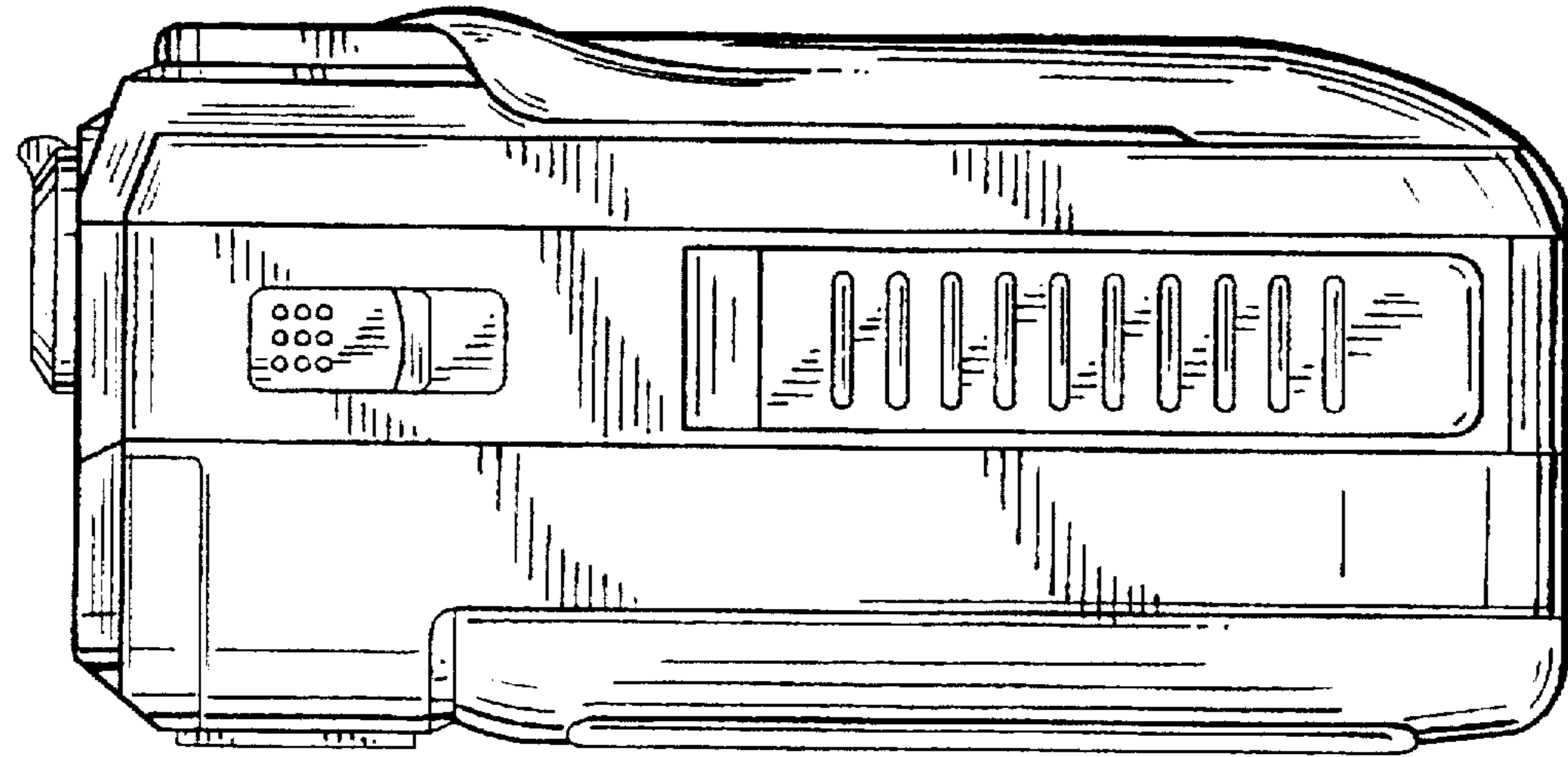

FIG. 8

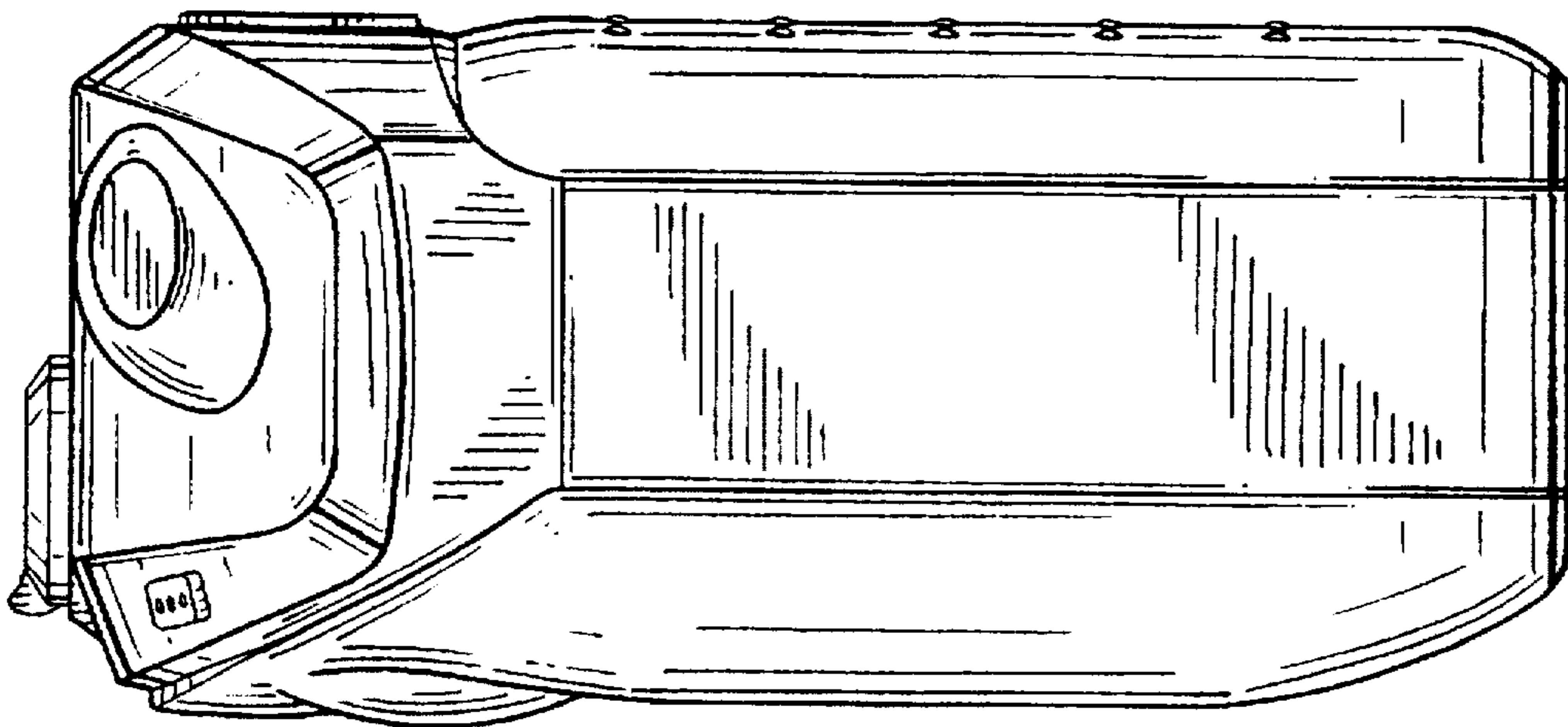

FIG. 7