



US00D394386S

United States Patent [19]
Fischer

[11] **Patent Number: Des. 394,386**

[45] **Date of Patent: **May 19, 1998**

[54] **GOLF BALL PACKAGE**

[75] **Inventor: Edward F. Fischer, Old Tappan, N.J.**

[73] **Assignee: Oak Tree Packaging Corporation, Montvale, N.J.**

[**] **Term: 14 Years**

[21] **Appl. No.: 68,490**

[22] **Filed: Mar. 21, 1997**

[51] **LOC (6) Cl. 09-07**

[52] **U.S. Cl. D9/432; D9/341; D9/431**

[58] **Field of Search D9/341, 346, 414, D9/418, 423, 430, 431, 432, 433; 206/315.9, 494; 220/410; 229/109, 110, 115, 120.01**

[56] **References Cited**

U.S. PATENT DOCUMENTS

D. 92,775	7/1934	Sekine	D9/418
D. 292,839	11/1987	Brogdon	D9/432 X
D. 306,402	3/1990	Colla	D9/414
D. 350,693	9/1994	Pratt	206/315.9 X
1,676,975	7/1928	Anderson et al.	206/315.9 X
5,195,633	3/1993	Kaminski	206/315.9
5,259,550	11/1993	Kuchenbecker	229/109
5,295,623	3/1994	Bacques et al.	229/109
5,487,468	1/1996	Sheahan	229/110 X

Primary Examiner—Ted Shooman
Assistant Examiner—Nanda Bondade
Attorney, Agent, or Firm—William H. Holt

[57] **CLAIM**

The ornamental design for a golf ball package, as shown and described.

DESCRIPTION

FIG. 1 is a perspective view of a package embodying my invention;
FIG. 2 is a top, plan view of FIG. 1;
FIG. 3 is a side, elevational view of FIG. 2;
FIG. 4 is an end, elevational view of FIGS. 1, 2 and 3;
FIG. 5 is a bottom view of the package of FIG. 2;
FIG. 6 is a perspective view of a sleeve for containing golf balls, shown separately for clarity of illustration; the broken lines showing the opening in the top surface is for illustrative purposes only and forms no part of the claimed design;
FIG. 7 is a top view of the sleeve of FIG. 6;
FIG. 8 is a side view of the sleeve of FIGS. 6 and 7, the opposite side being identical;
FIG. 9 is a end view of the sleeve of FIGS. 6 and 7, the opposite end being identical; and,
FIG. 10 is an exploded view of FIG. 1, the broken lines showing each sleeve having an opening in the top surface is for illustrative purposes only and forms no part of the claimed design.

1 Claim, 4 Drawing Sheets

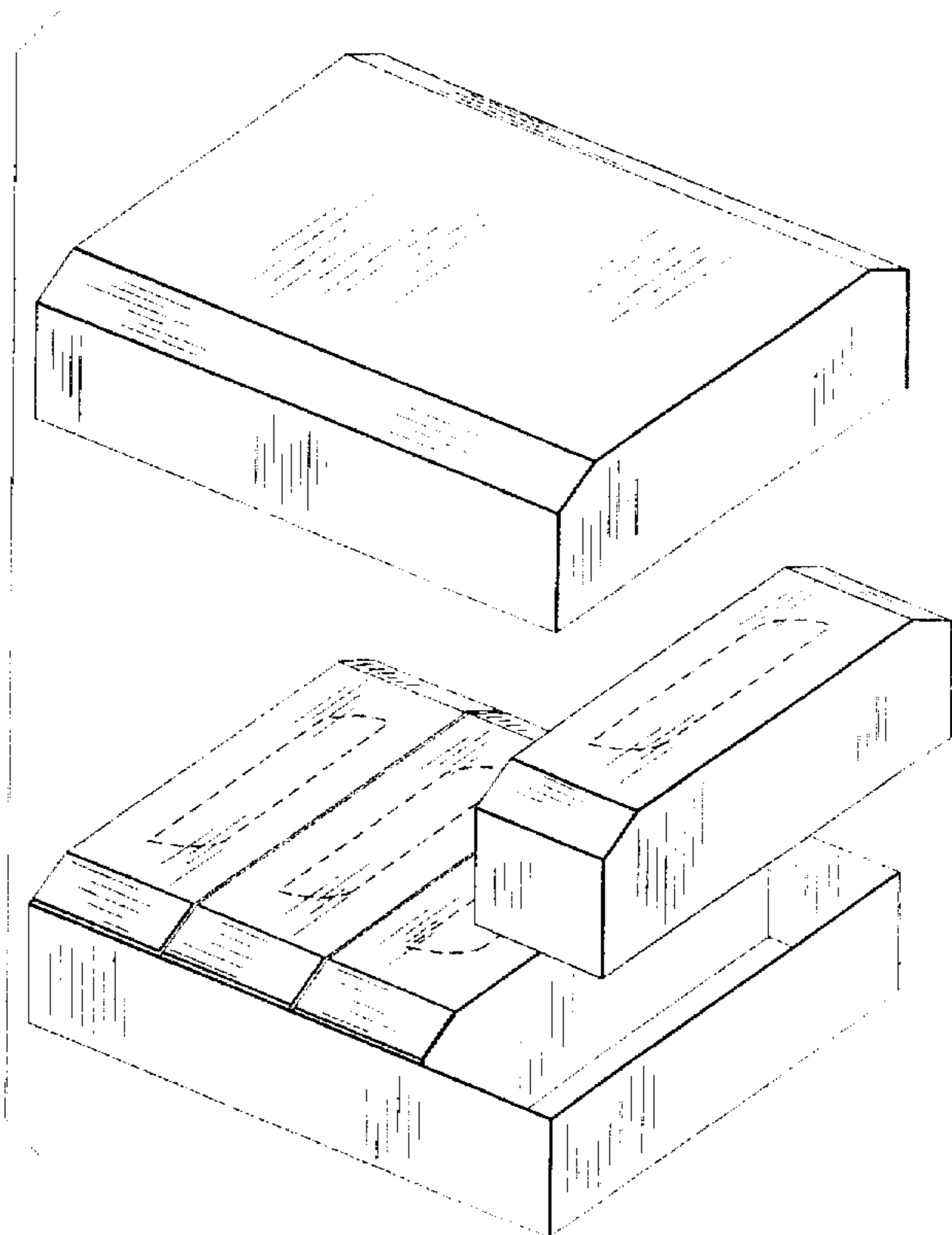
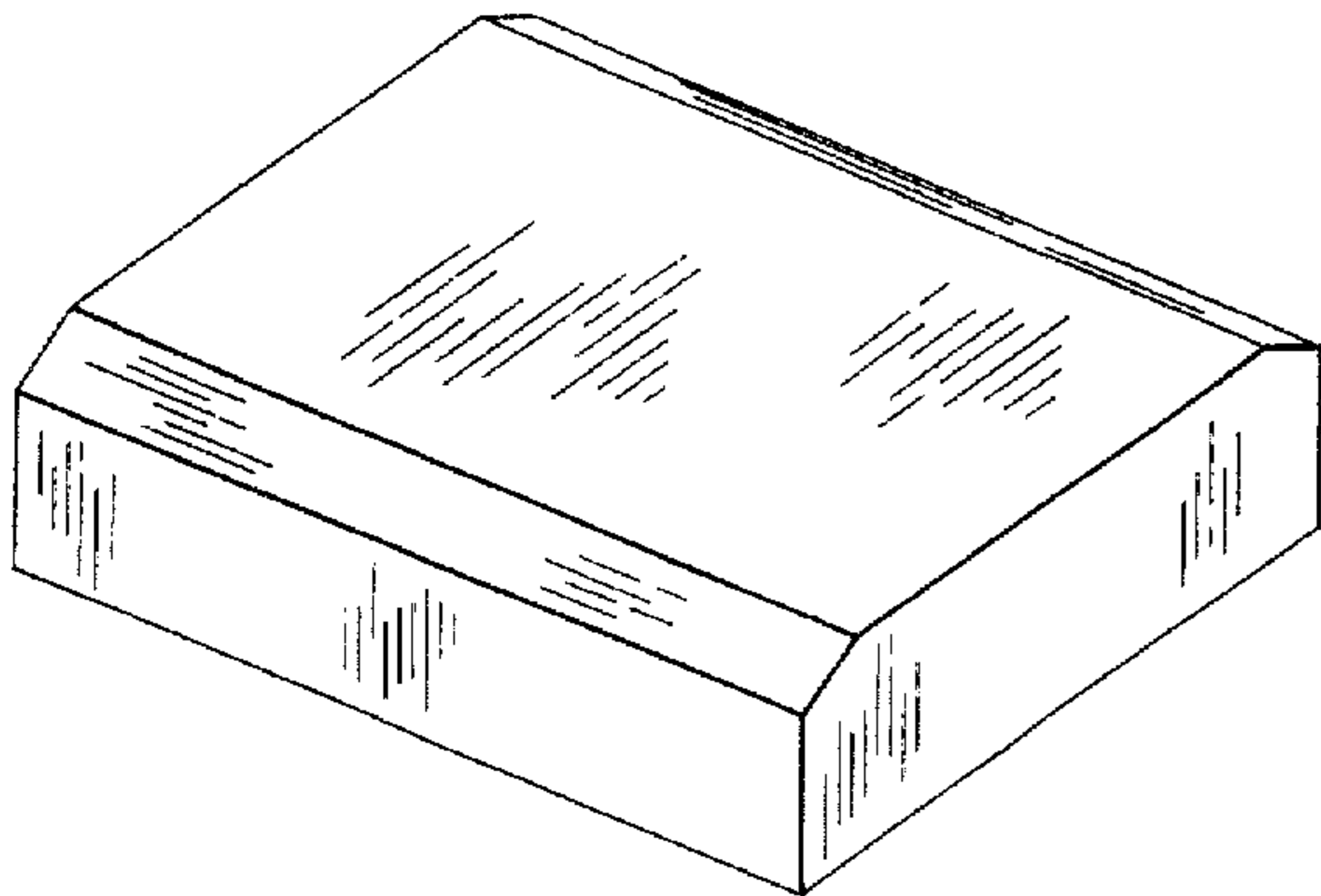

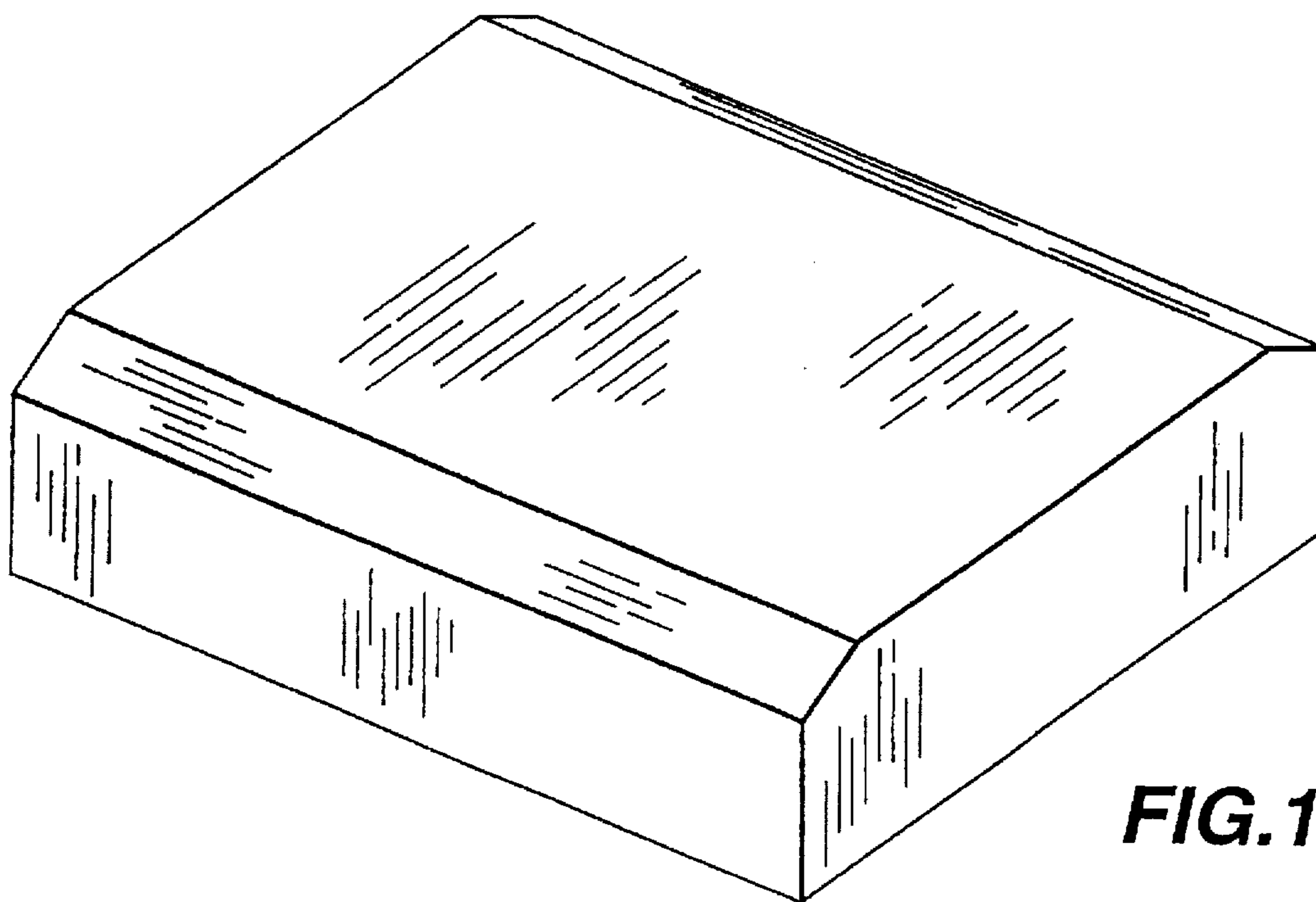

FIG. 1

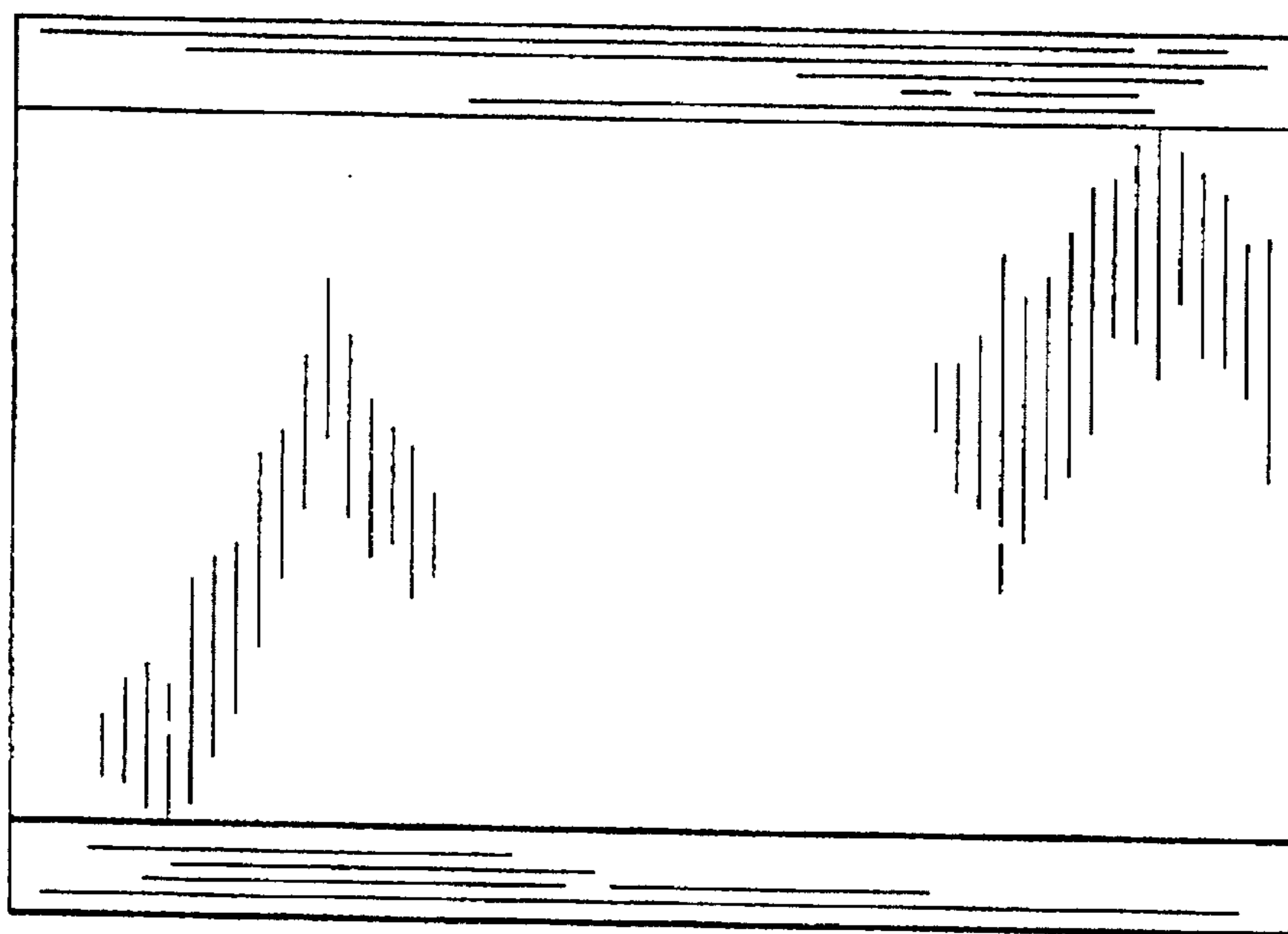

FIG. 2

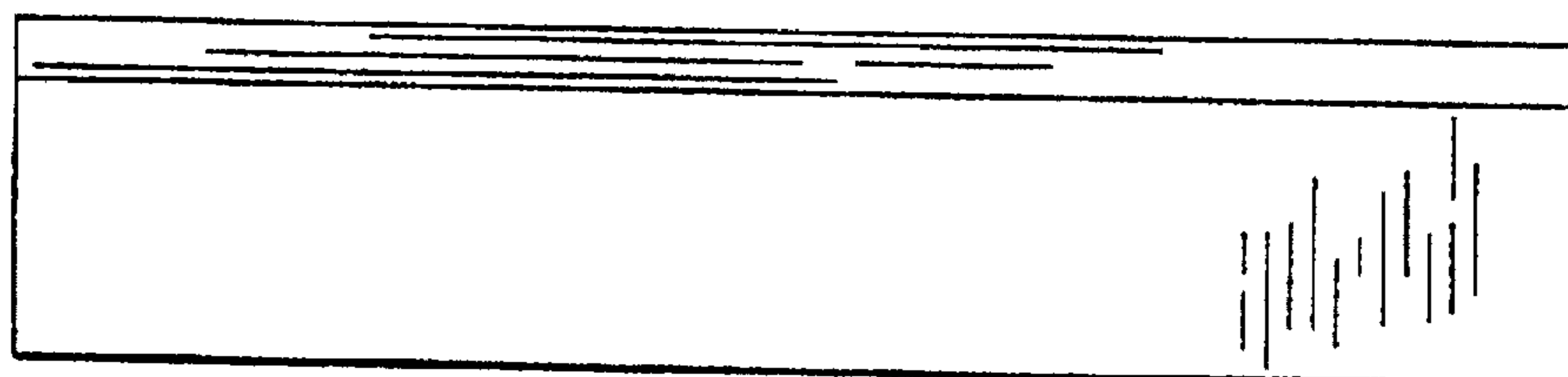

FIG. 3

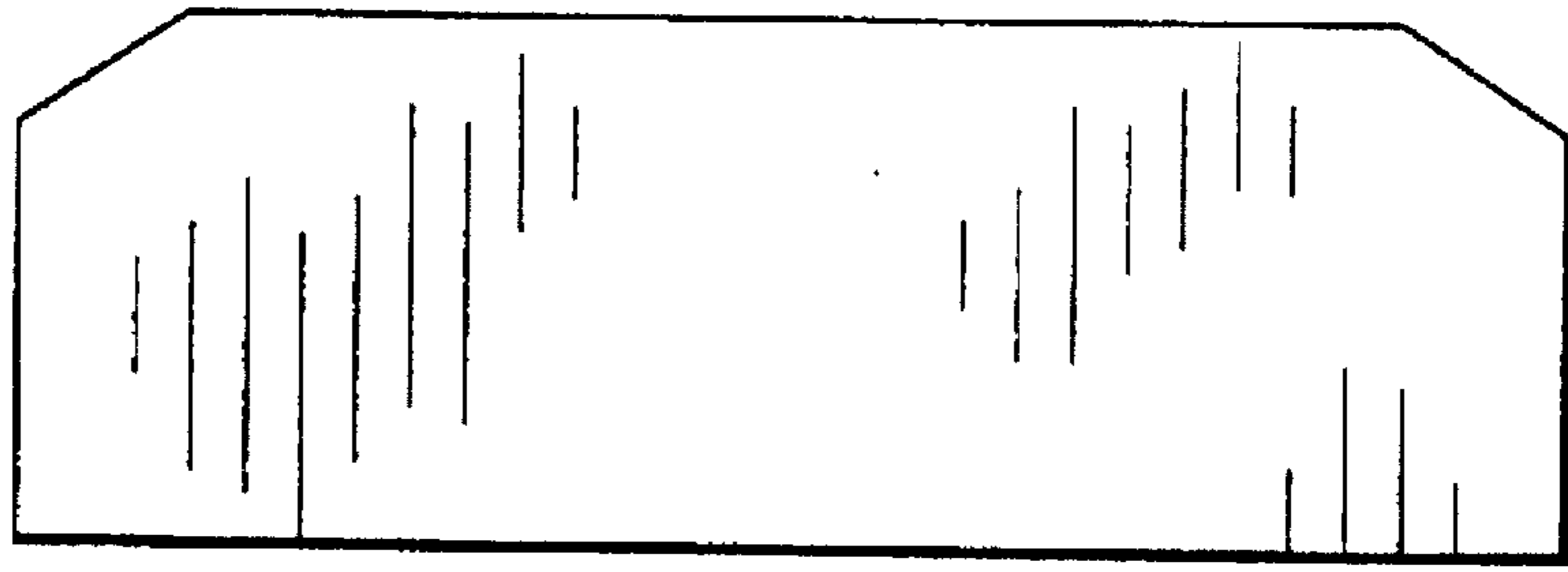

FIG. 4

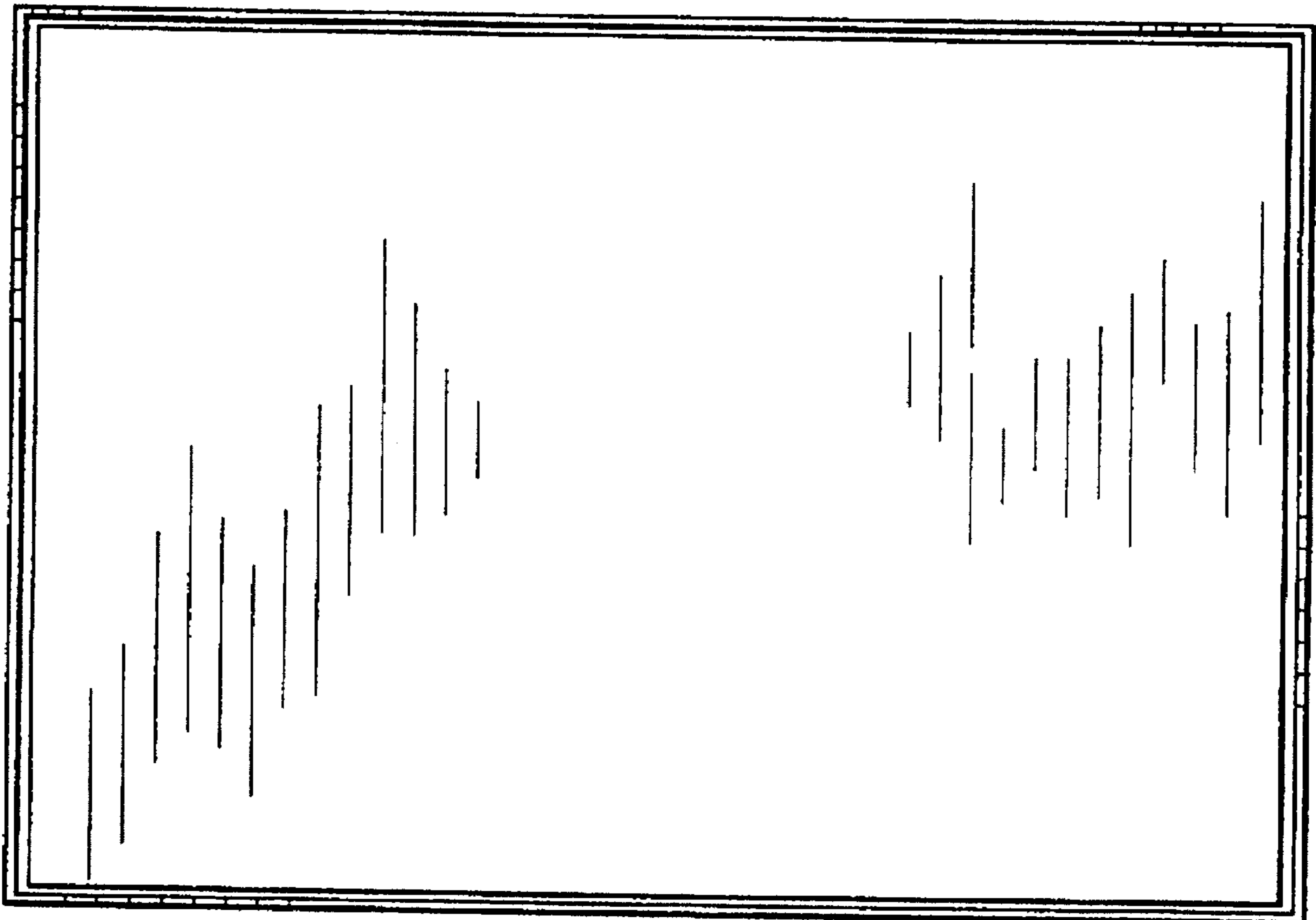

FIG. 5

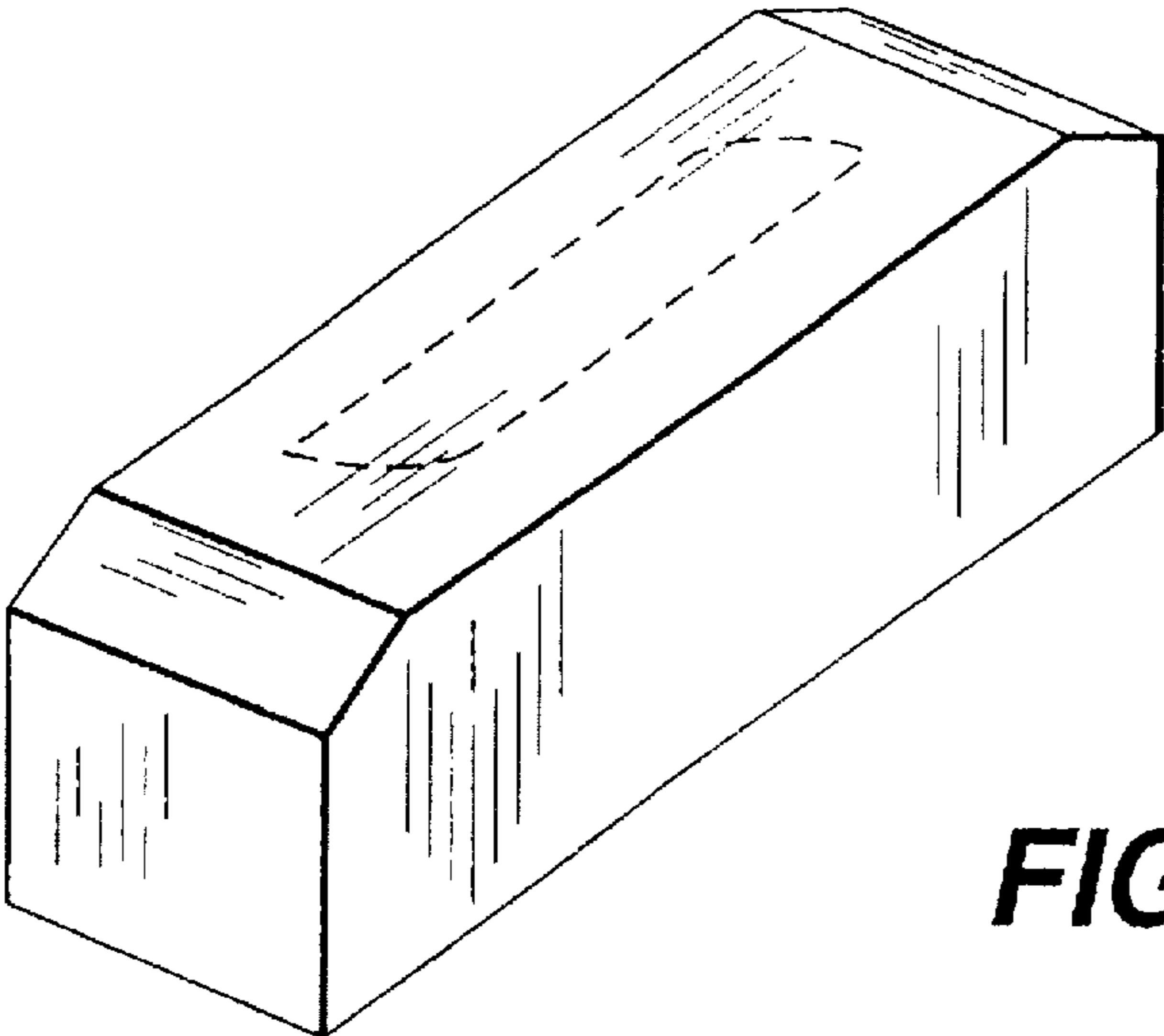

FIG. 6

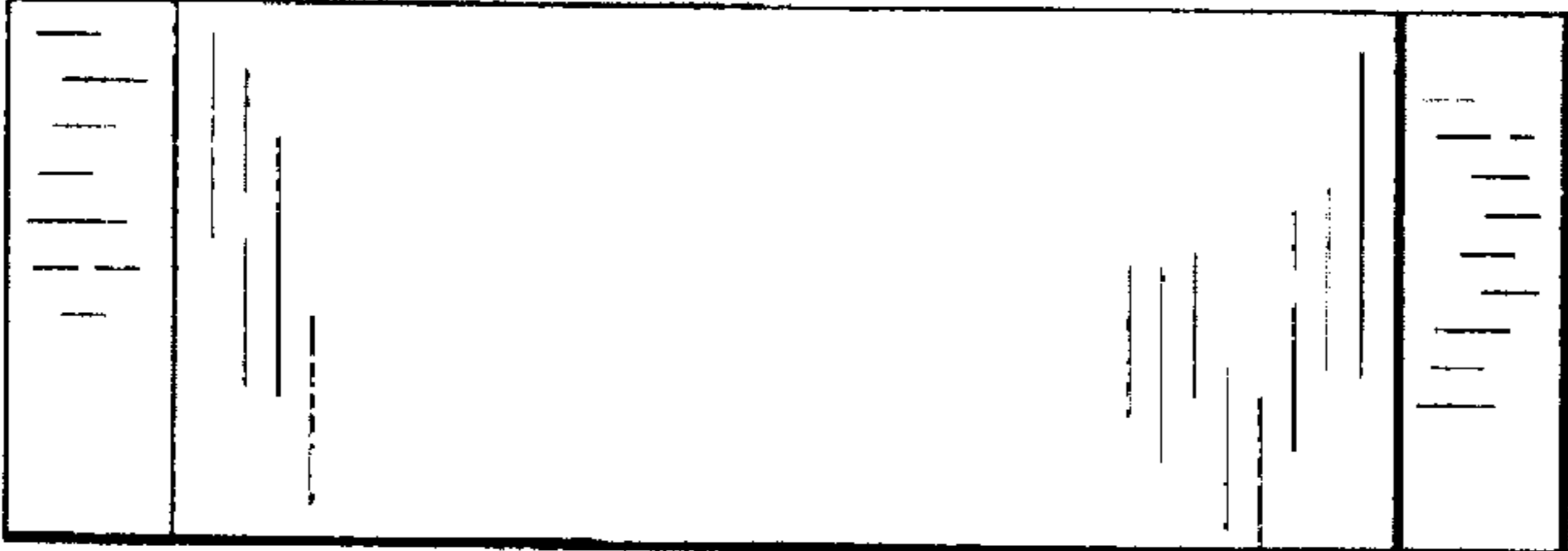

FIG. 7

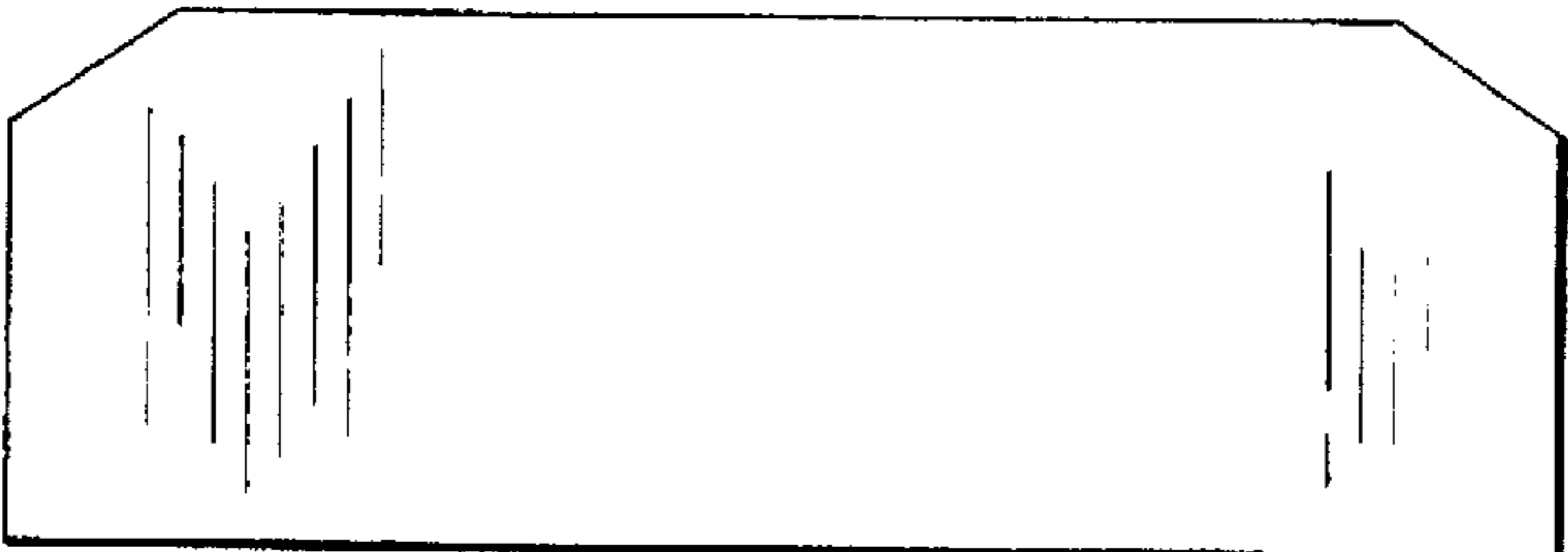

FIG. 8

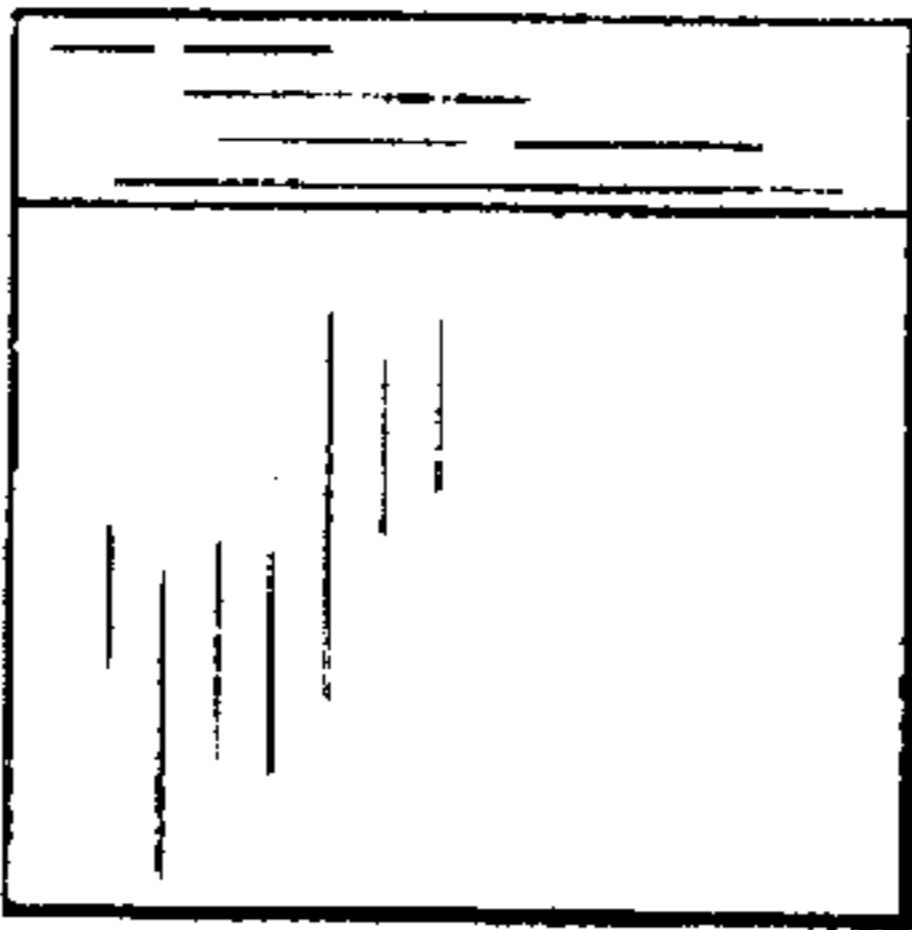

FIG. 9

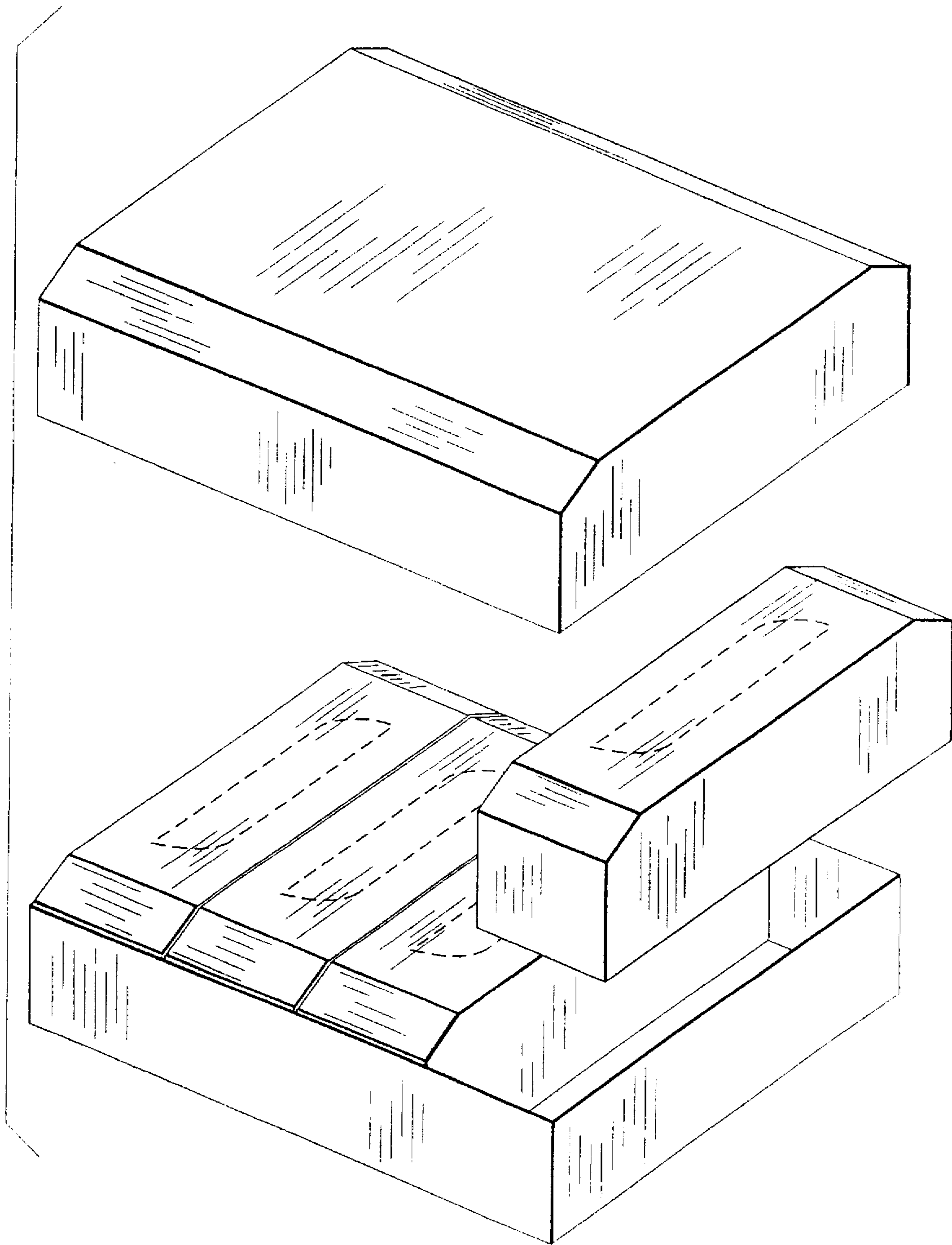

FIG. 10