



US00D394346S

United States Patent [19]
MacDonald

[11] **Patent Number: Des. 394,346**
[45] **Date of Patent: **May 19, 1998**

[54] **KEY RING HOLDER**

[76] **Inventor: Sumner MacDonald, 44 Ballou Blvd., Bristol, R.I. 02809**

[**] **Term: 14 Years**

[21] **Appl. No.: 70,314**

[22] **Filed: May 6, 1997**

[51] **LOC (6) Cl. 03-01**

[52] **U.S. Cl. D3/207**

[58] **Field of Search D3/207-211, 221; 70/456 R-460; 24/3.6**

[56] **References Cited**

U.S. PATENT DOCUMENTS

D. 237,817	11/1975	Foreman	D11/79
D. 278,575	4/1985	Bassani	D3/207
D. 357,114	4/1995	MacDonald	D3/207
3,613,416	10/1971	Paton	70/456 R

Primary Examiner—Ralf Seifert
Attorney, Agent, or Firm—Robert J. Doherty

[57] **CLAIM**

The ornamental design for a key ring holder, as shown and described.

DESCRIPTION

FIG. 1 is a front elevational view of a key ring holder showing my new design;

FIG. 2 is a rear elevational view thereof;

FIG. 3 is a right side elevational view thereof;

FIG. 4 is a left side elevational view thereof;

FIG. 5 is a top plan view thereof;

FIG. 6 is a bottom plan view thereof;

FIG. 7 is a front elevational view of a modified form of a key ring holder showing my new design;

FIG. 8 is a rear elevational view of FIG. 7;

FIG. 9 is a right elevational view of FIG. 7;

FIG. 10 is a left side elevational view of FIG. 7;

FIG. 11 is a top plan view of FIG. 7;

FIG. 12 is a bottom plan view of FIG. 7;

FIG. 13 is a front elevational view of another modified form of a key ring holder showing my design;

FIG. 14 is a rear elevational view of FIG. 13;

FIG. 15 is a right side elevational view of FIG. 13;

FIG. 16 is a left side elevational view of FIG. 13;

FIG. 17 is a top plan view of FIG. 13; and,

FIG. 18 is a bottom plan view of FIG. 13.

The broken line showing of key rings in FIGS. 1, 7 and 13 are for illustrative purposes and form no part of the claimed design

1 Claim, 3 Drawing Sheets

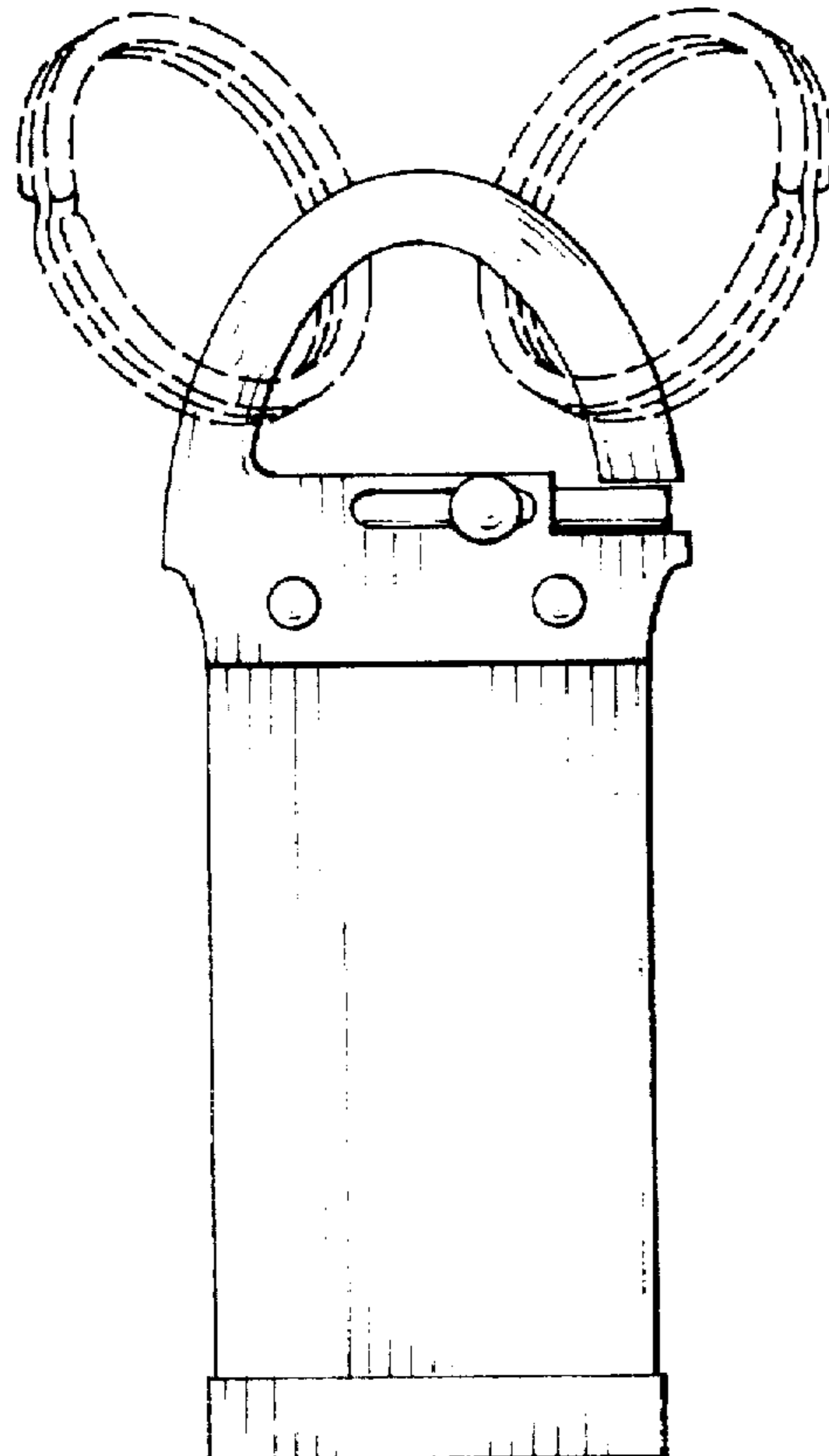

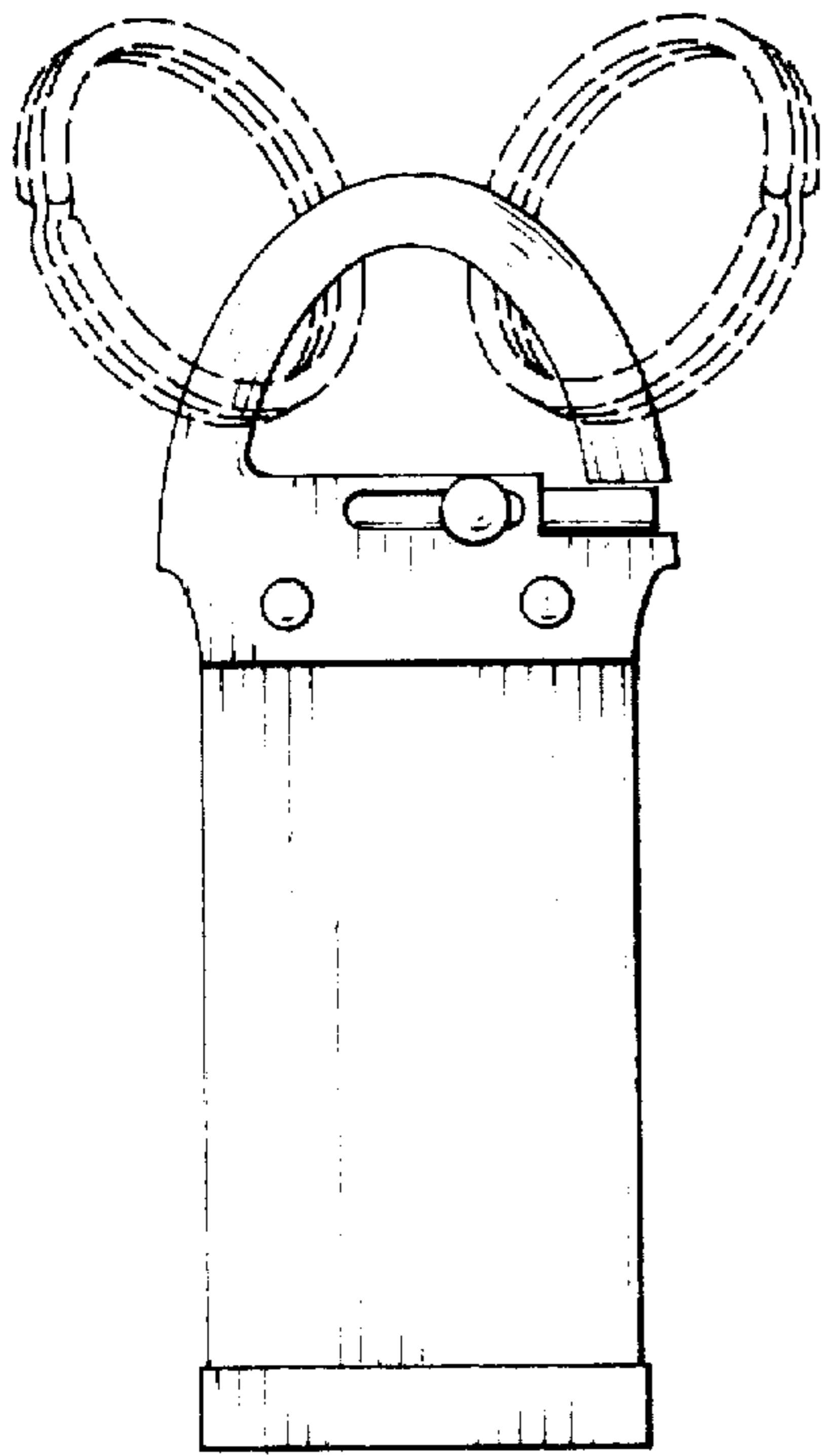

FIG. 1

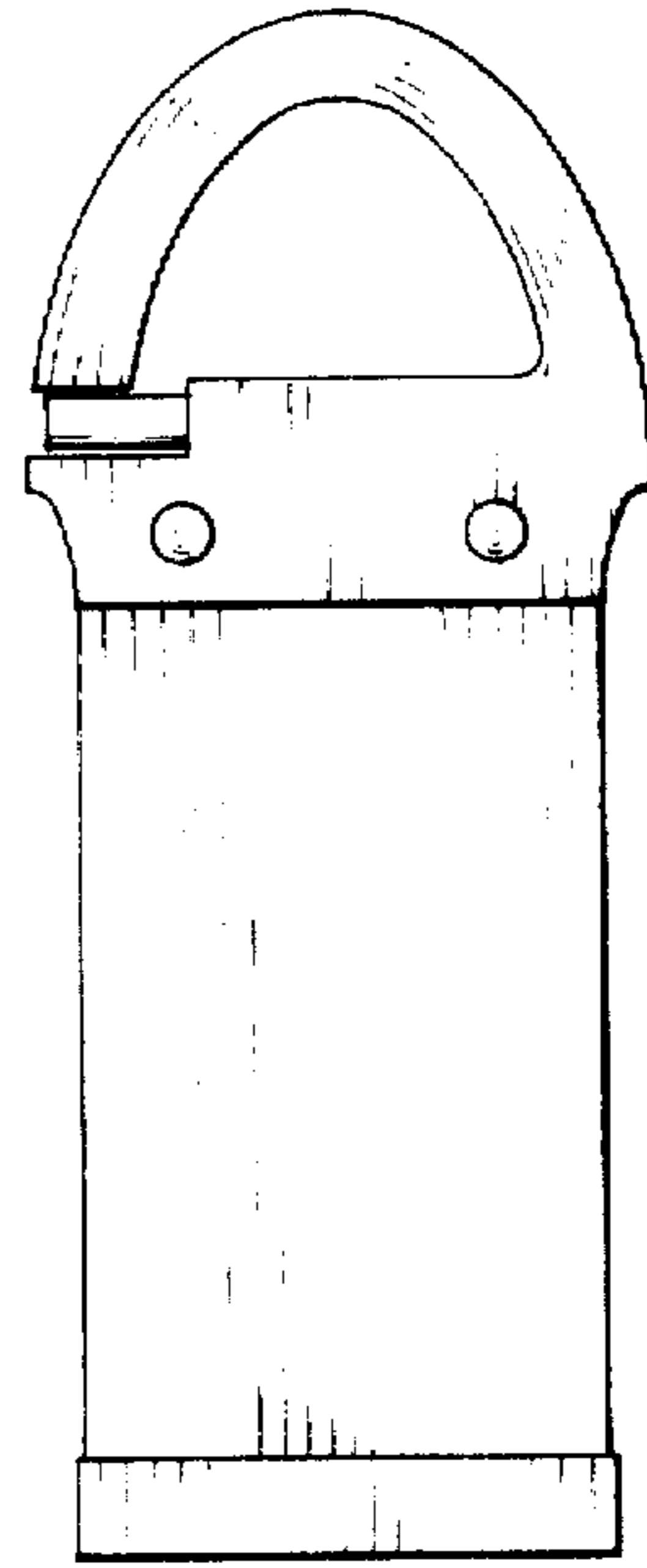

FIG. 2

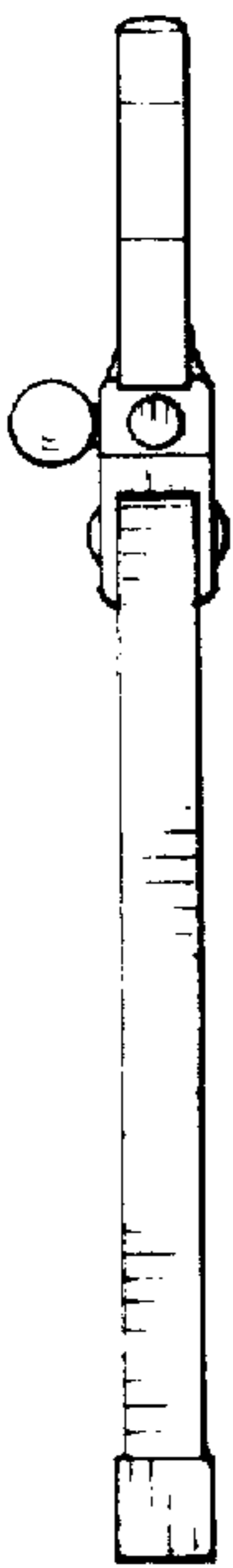

FIG. 3



FIG. 4

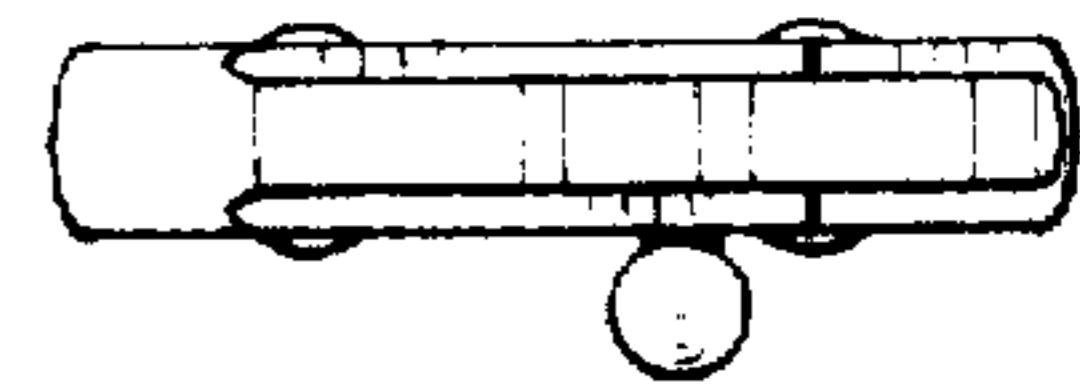

FIG. 5

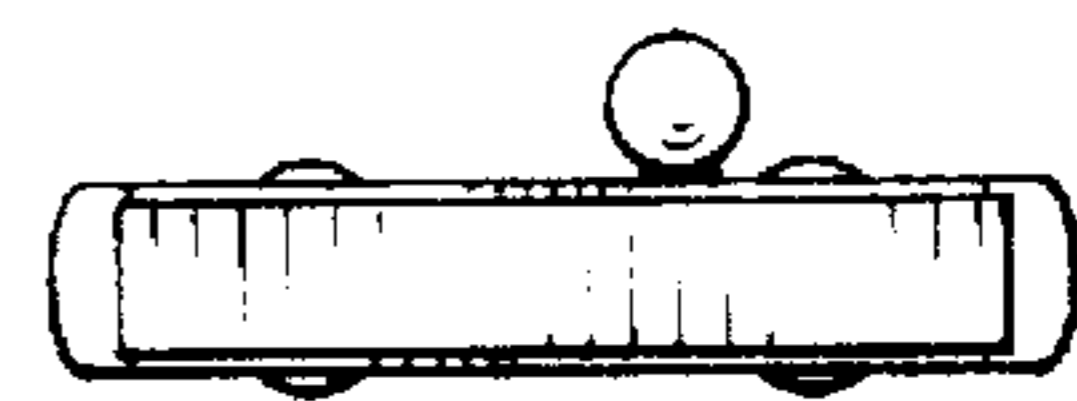

FIG. 6

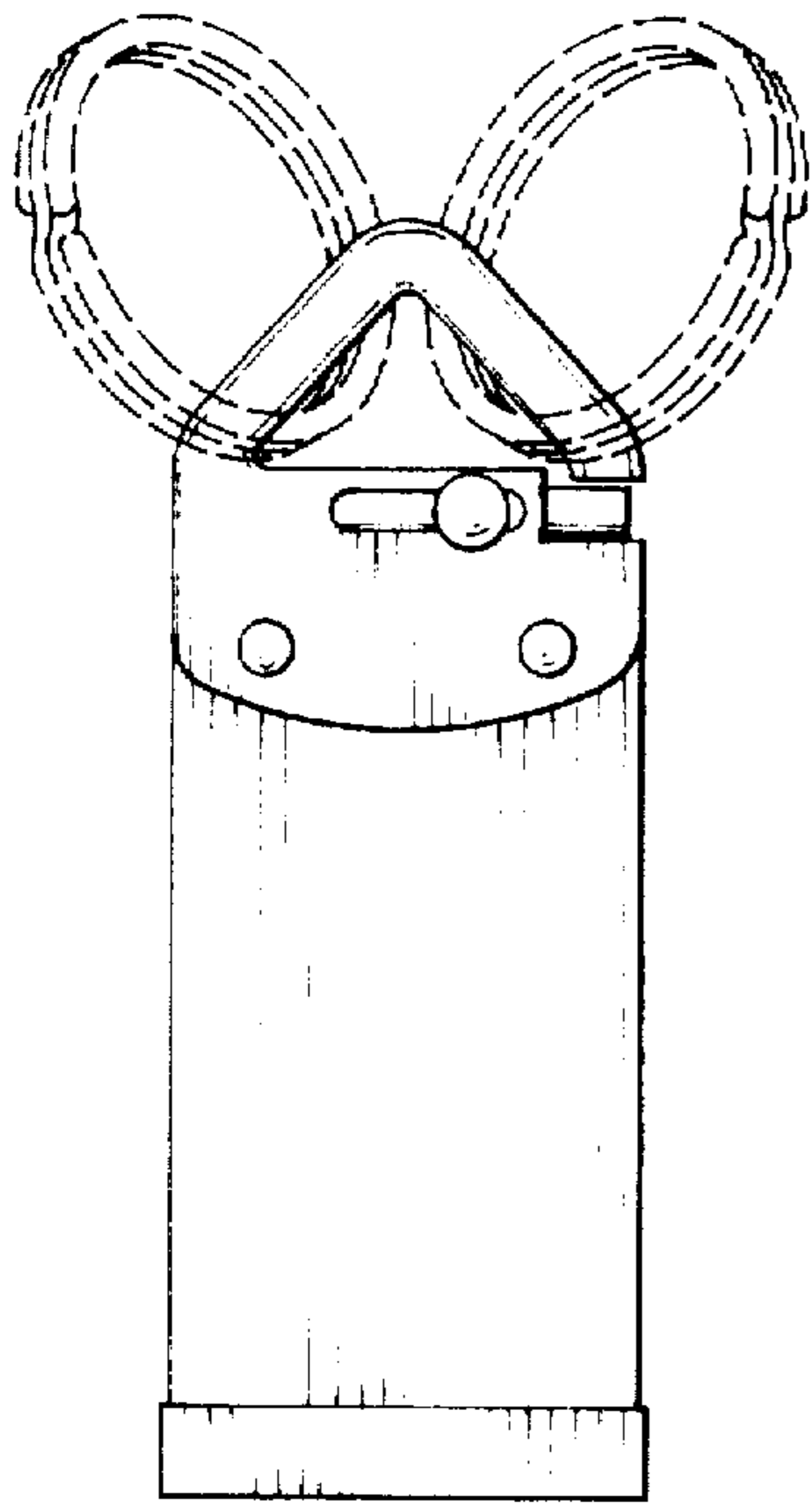

FIG. 7

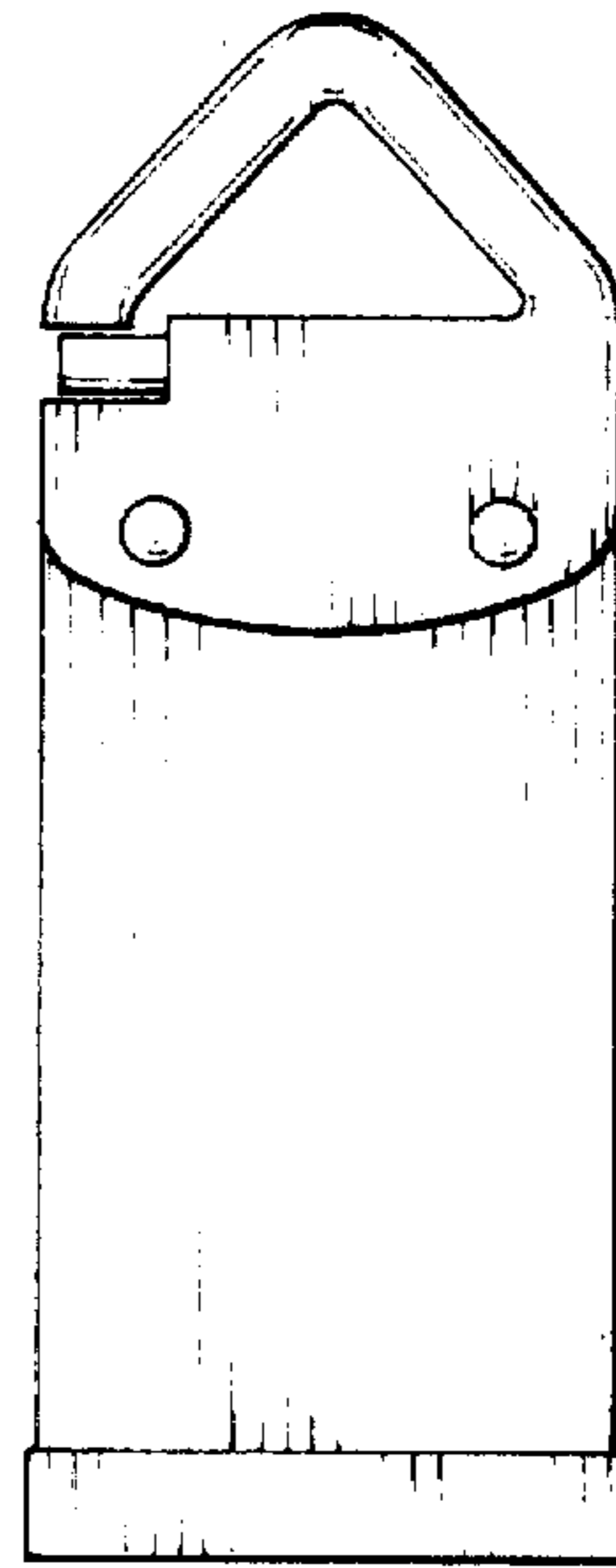

FIG. 8



FIG. 9

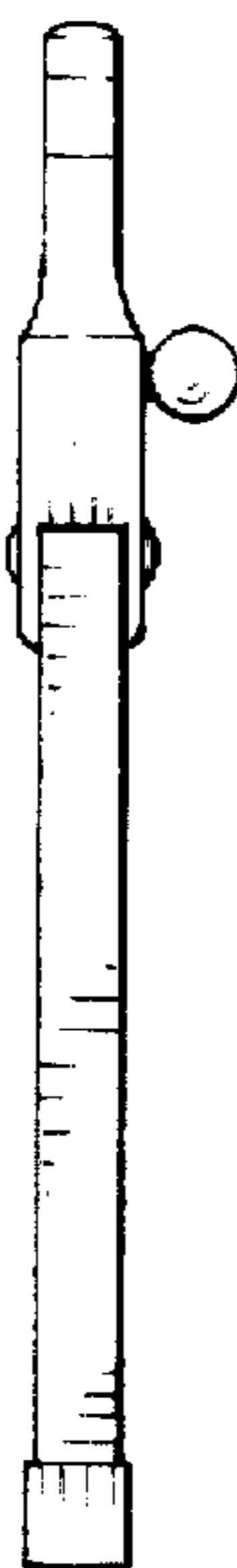

FIG. 10

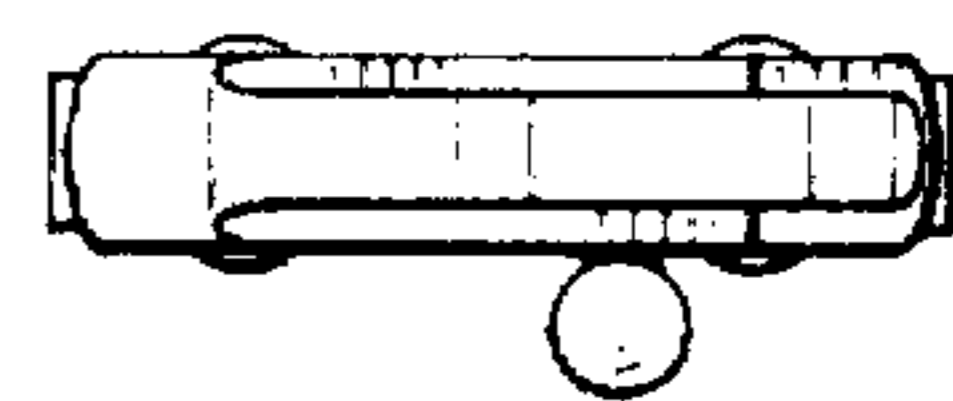

FIG. 11



FIG. 12

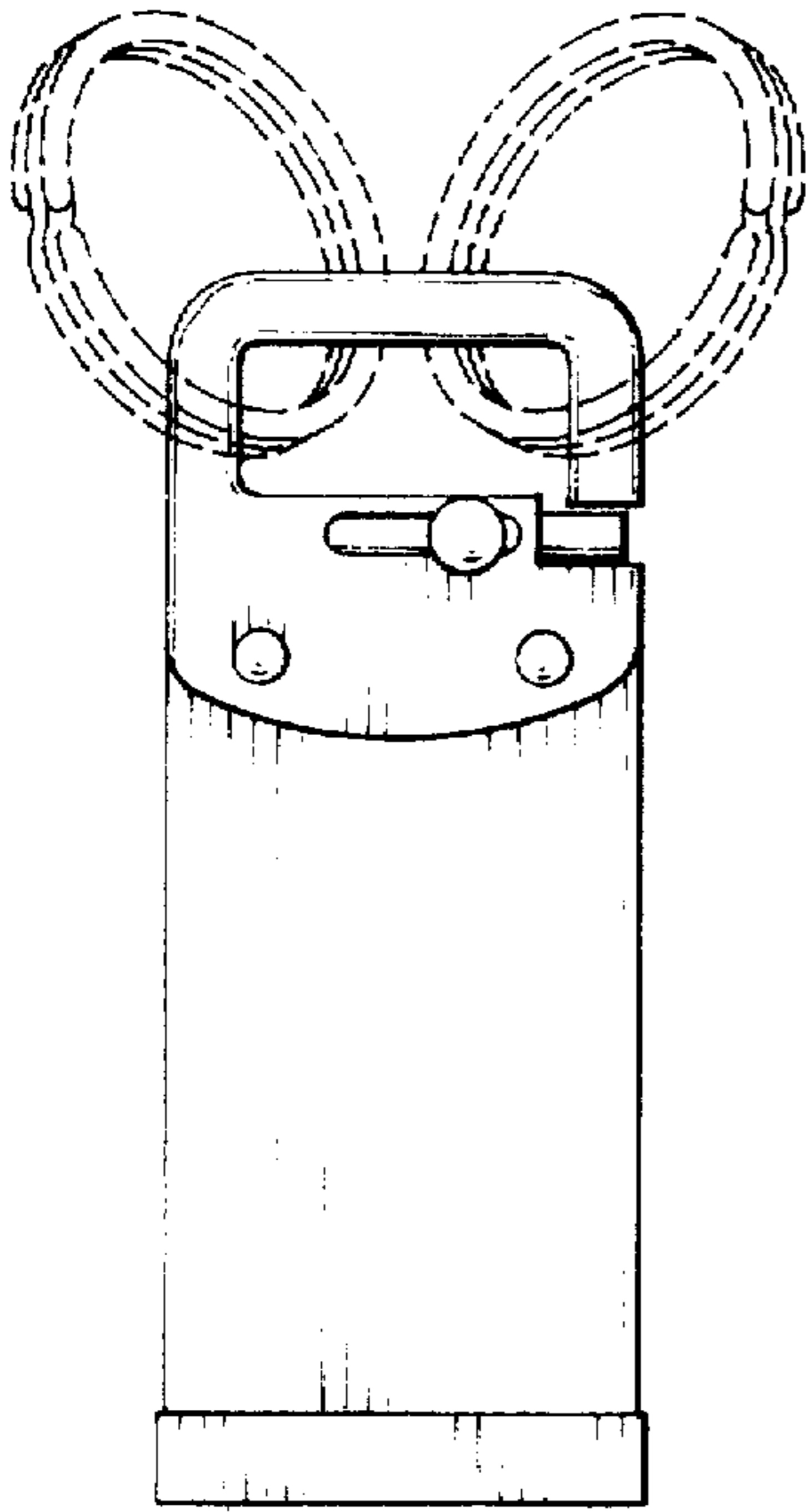

FIG. 13

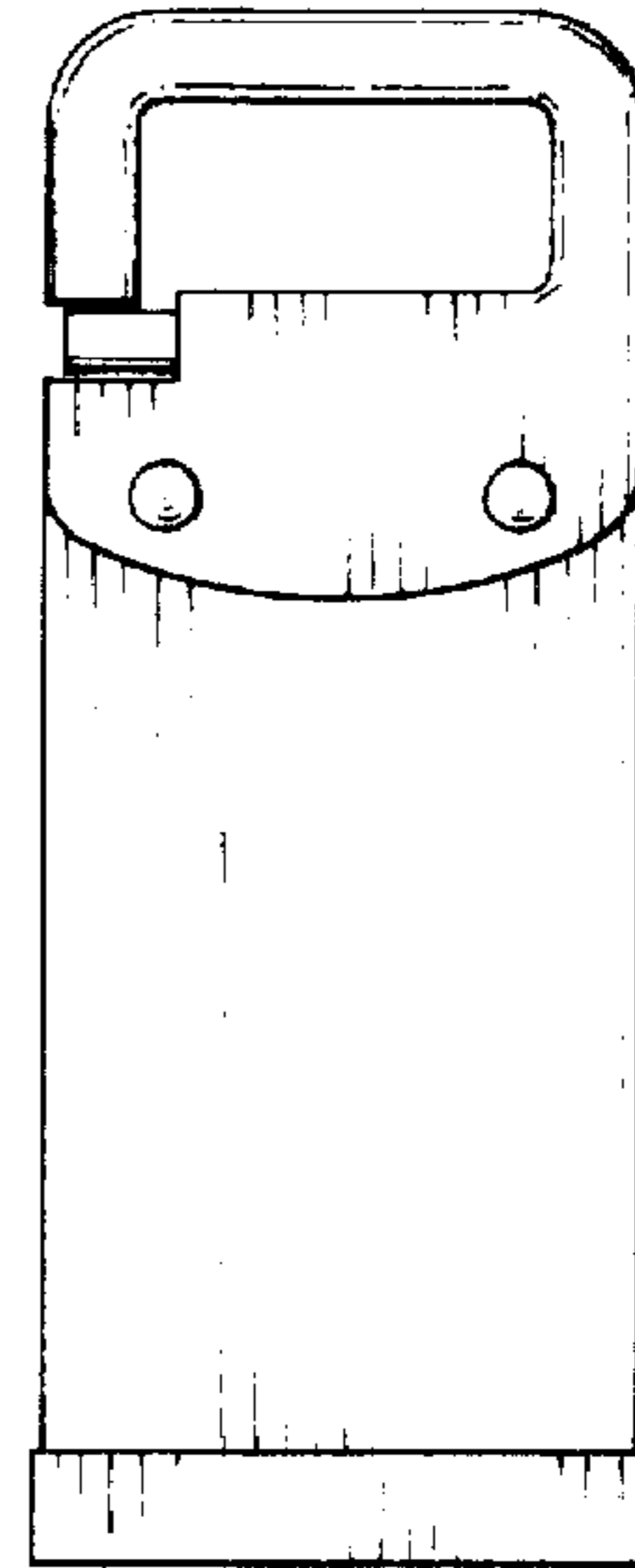

FIG. 14

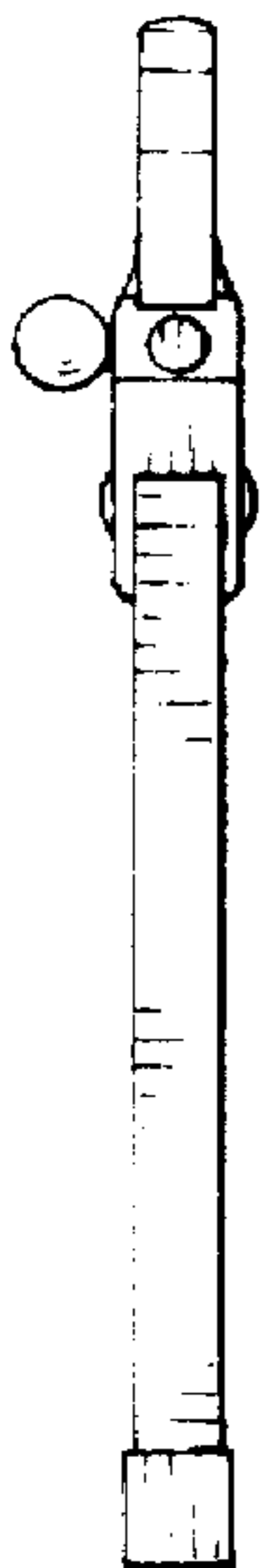

FIG. 15



FIG. 16

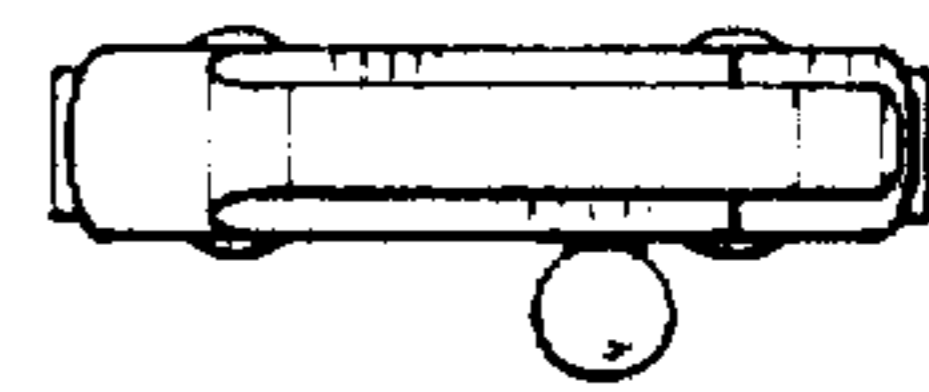

FIG. 17

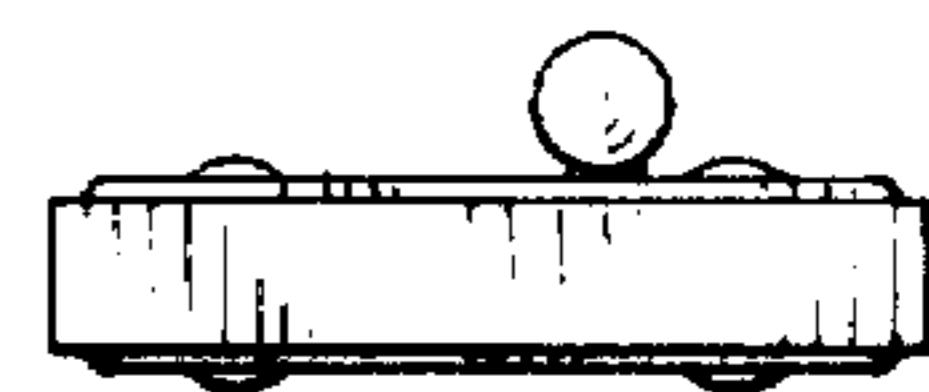

FIG. 18