



US00D394302S

# United States Patent [19]

Harris et al.

[11] Patent Number: **Des. 394,302**

[45] Date of Patent: **\*\*May 12, 1998**

## [54] CONTAINER FOR BULK MATERIALS

[75] Inventors: **Jack E. Harris**, Savannah, Ga.; **Robert A. Bromwell**, Royal Oak, Mich.; **Karl L. Sommer**, Rochester Hills, Mich.; **Gerald L. Blake**, Farmington Hills, Mich.

[73] Assignee: **Encon, Inc.**, Romeo, Mich.

[\*\*] Term: **14 Years**

[21] Appl. No.: **23,749**

[22] Filed: **Jun. 1, 1994**

[51] LOC (6) Cl. .... **23-01**

[52] U.S. Cl. .... **D23/202; D23/200**

[58] Field of Search ..... **D23/200-209; 206/386, 398, 599; 210/192, 222, 223, 257.2, 282, 446, 448, 744; 220/1.5, 4.21, 633; 222/185, 189**

5,111,937	5/1992	Schutz	.....	206/386
5,133,476	7/1992	Schutz	.....	220/622
5,154,297	10/1992	Farley	.....	206/599
5,156,268	10/1992	Nichols	.....	206/386
5,201,432	4/1993	Elvin-Jensen	.....	220/1.5
5,224,635	7/1993	Wise	.....	206/599 X

### FOREIGN PATENT DOCUMENTS

92-21575 12/1992 WIPO .

### OTHER PUBLICATIONS

"Introducing Tuff Tank". Chemical Handling Equipment Co., Inc., 5451 Enterprise Blvd., Toledo, Ohio 43612; 2 pages; 1987.

"Atlas 360" and Saturn 350; Georgia Polymer Inc., P.O. Box 161554, Atlanta, Georgia 30321; 4 pages; date unknown. 1 page from "Hazmat World"; 1991.

1 page; Consolidated Plastics, Twinsburg, Ohio 44087; date unknown.

Enpac Corporation, 8400 Baymeadows Way, Bldg. 18, Jacksonville, Florida 32256; 1 page; 1991.

(List continued on next page.)

## [56] References Cited

### U.S. PATENT DOCUMENTS

D. 216,590	2/1970	Coleman	.....	D23/202
D. 298,450	11/1988	Thomas et al.	.....	D23/202
D. 319,904	9/1991	Cozzi et al.	.....	D9/414 X
D. 332,130	12/1992	Pryztulla	.....	D23/202
D. 337,367	7/1993	McKenzie et al.	.....	D23/202
D. 349,944	8/1994	Harris	.....	D23/202
2,887,251	5/1959	Mackridge	.....	222/131
3,729,121	4/1973	Cannon	.....	222/185
3,782,602	1/1974	Page	.....	222/143
4,157,609	6/1979	Schutz	.....	29/428
4,173,288	11/1979	Schutz	.....	220/1.5
4,426,015	1/1984	Preston et al.	.....	220/403
4,516,692	5/1985	Croley	.....	222/105
4,690,299	9/1987	Cannon	.....	220/402
4,746,034	5/1988	Ata et al.	.....	222/143
4,793,519	12/1988	Voorhies, Jr.	.....	220/465
4,930,661	6/1990	Voorhies	.....	220/465
4,995,588	2/1991	Nichols	.....	251/144
5,024,346	6/1991	Roser	.....	220/401
5,029,734	7/1991	Nichols	.....	222/105
5,064,096	11/1991	Illing et al.	.....	222/104
5,105,947	4/1992	Wise	.....	206/599 X
5,110,000	5/1992	Nichols	.....	220/4.16

*Primary Examiner*—Louis S. Zarfes

*Assistant Examiner*—Monica A. Hannon

*Attorney, Agent, or Firm*—Renner, Kenner, Greive, Bobak, Taylor & Weber

## [57] CLAIM

The ornamental design for a container for bulk materials, as shown and described.

## DESCRIPTION

FIG. 1 is a top, front, and right side perspective view of a container for bulk materials embodying our new design;

FIG. 2 is a front elevational view thereof;

FIG. 3 is a left side elevational view thereof, the right side being a mirror image of the left side;

FIG. 4 is a rear elevational view thereof;

FIG. 5 is a top plan view thereof; and,

FIG. 6 is a bottom plan view thereof.

**1 Claim, 4 Drawing Sheets**

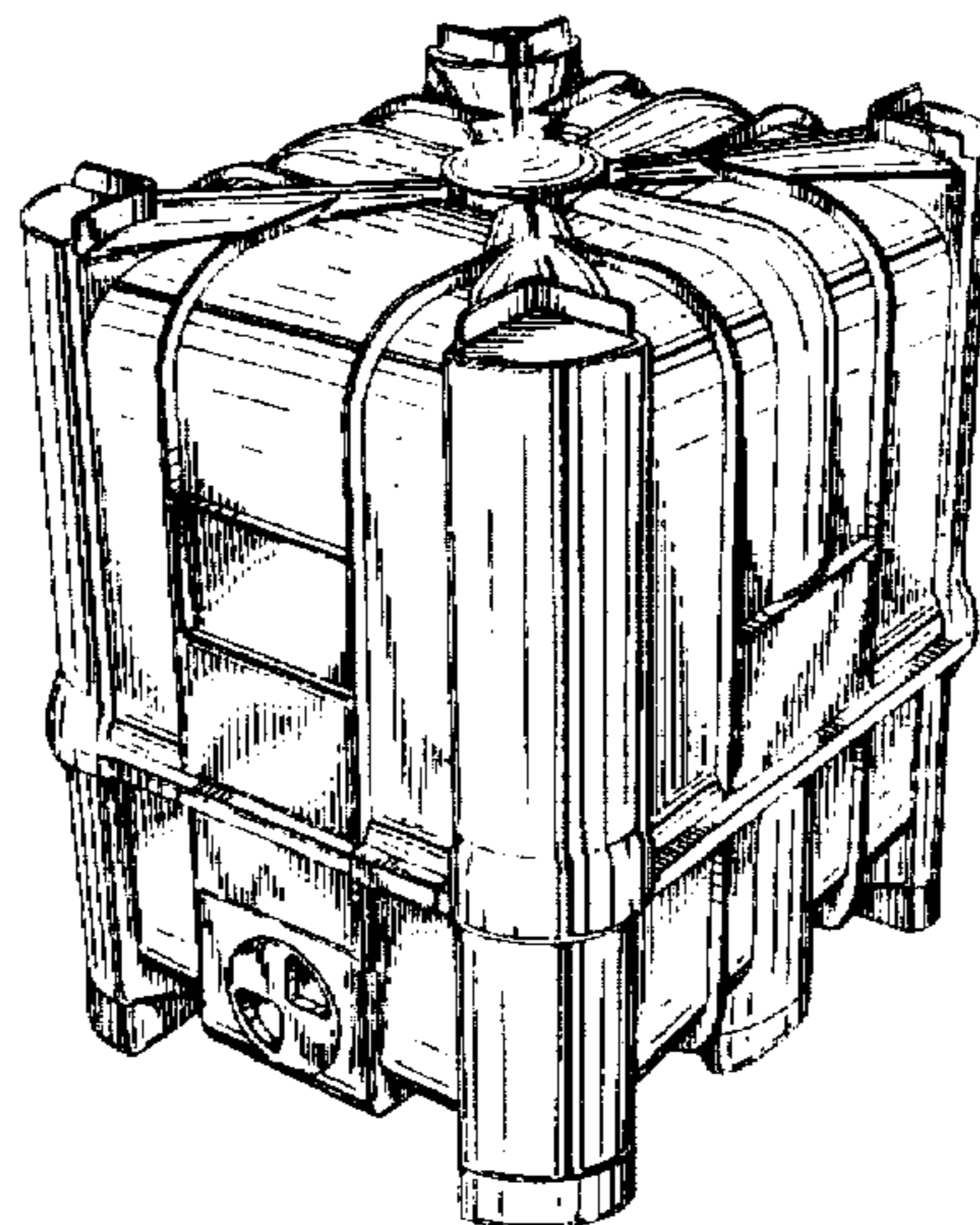

**OTHER PUBLICATIONS**

"The Uni-Pak Bulk System"; Shuert Industries Sales Inc., 6600 Dobry Road, Sterling Heights, MI 48314; 6 pages; date unknown.

21st Century Containes, Ltd., 150 Selig Drive, Atlanta, Georgia 30336; 5 pages; 1992.

"Concertainer"; Van Leer Nederland B.V., Fibre Drums & Plastic Containers, Keulsekade 216, 3534 AC Utrecht; 4 pages; date unknown.

"The Sonobulk System"; Sonoco IBC, 100 Alex Street, Lavonia, GA 30553; 8 pages; date unknown.

Bonar Plastics Inc., 1005 Atlantic Drive, West Chicago, Illinois 60185; 39 pages; date unknown.

"Duratank", Hoover Group Incorporated, Alpharetta, Georgia 30201; 26 pages; 1991.

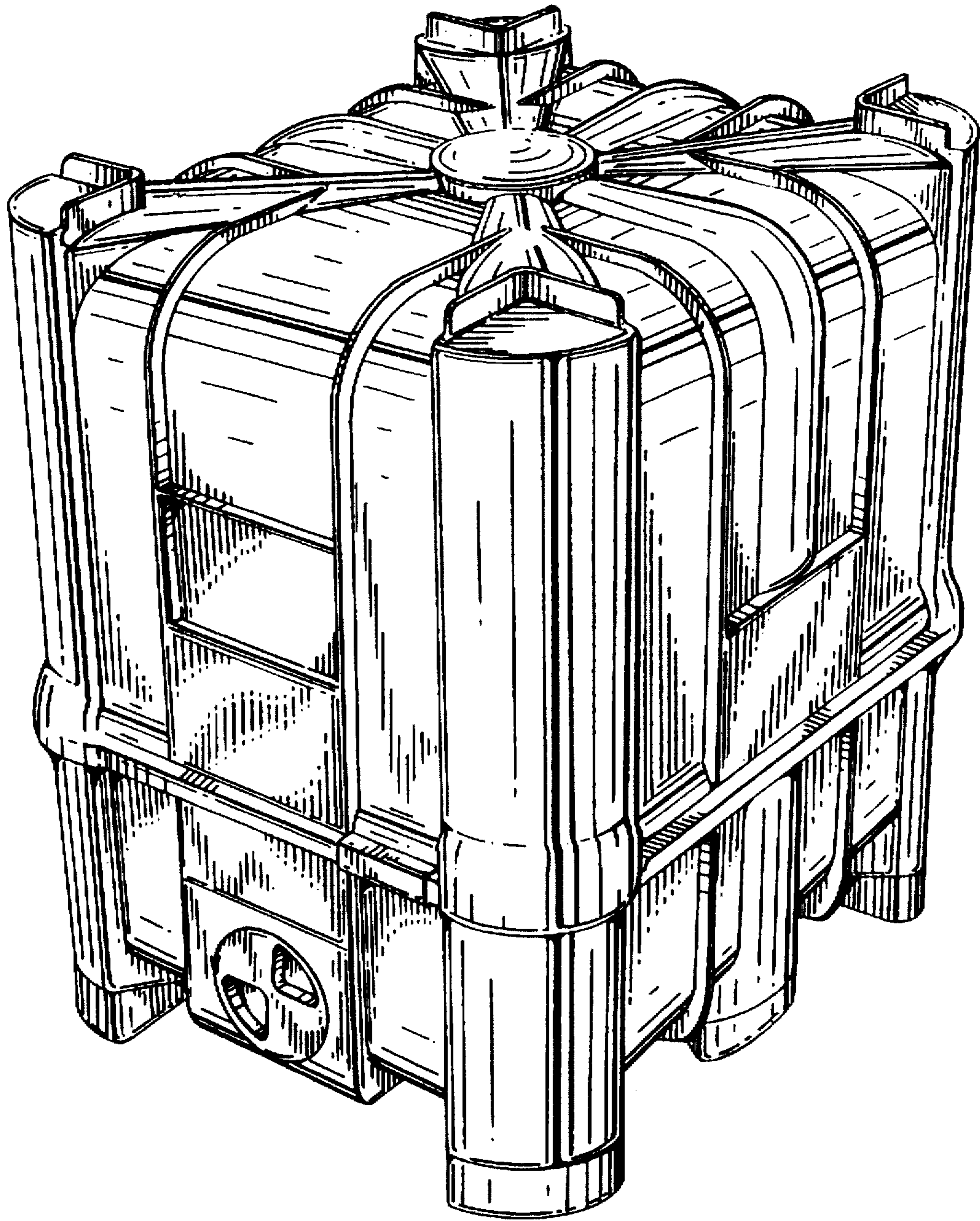

FIG. 1



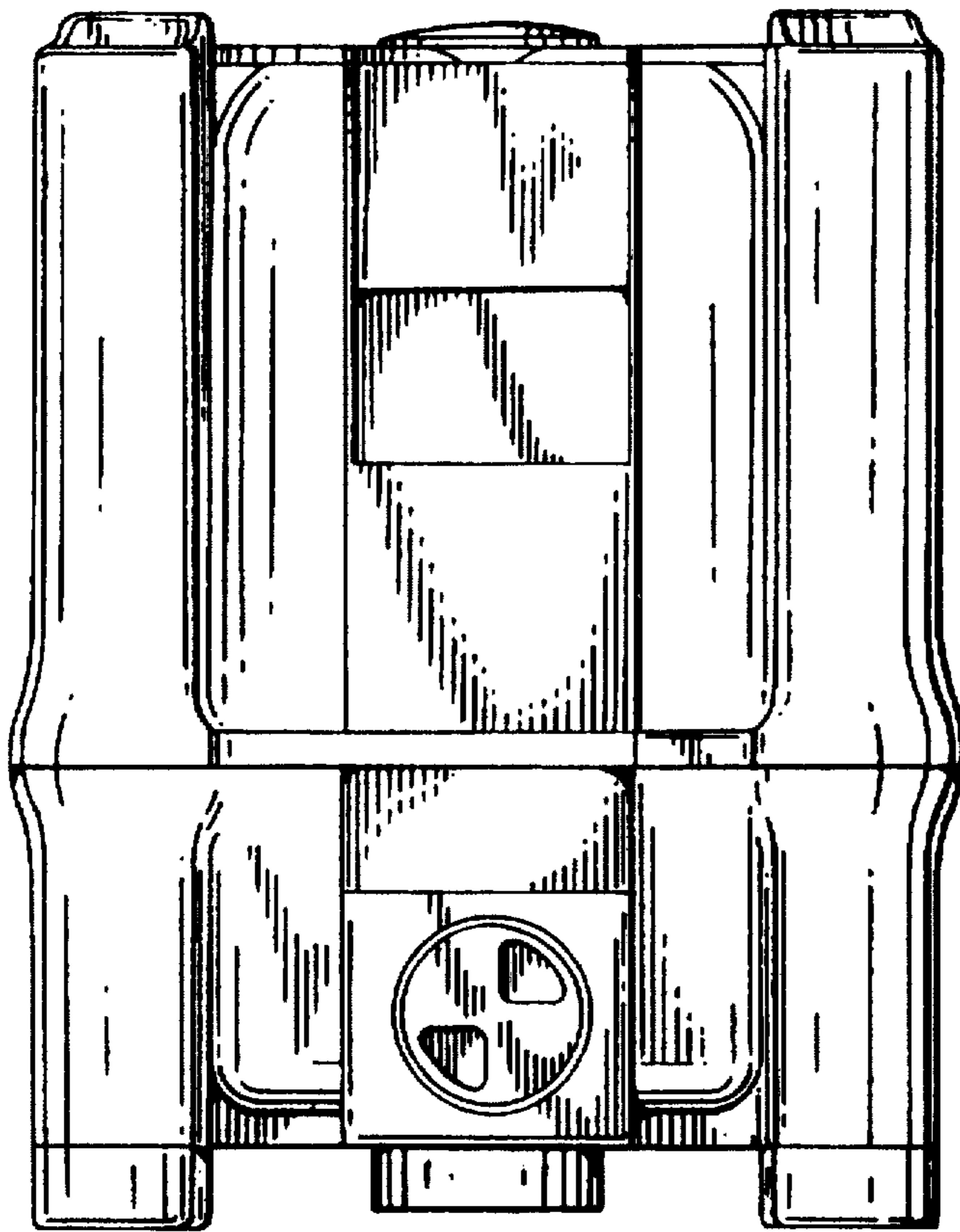

FIG. 2

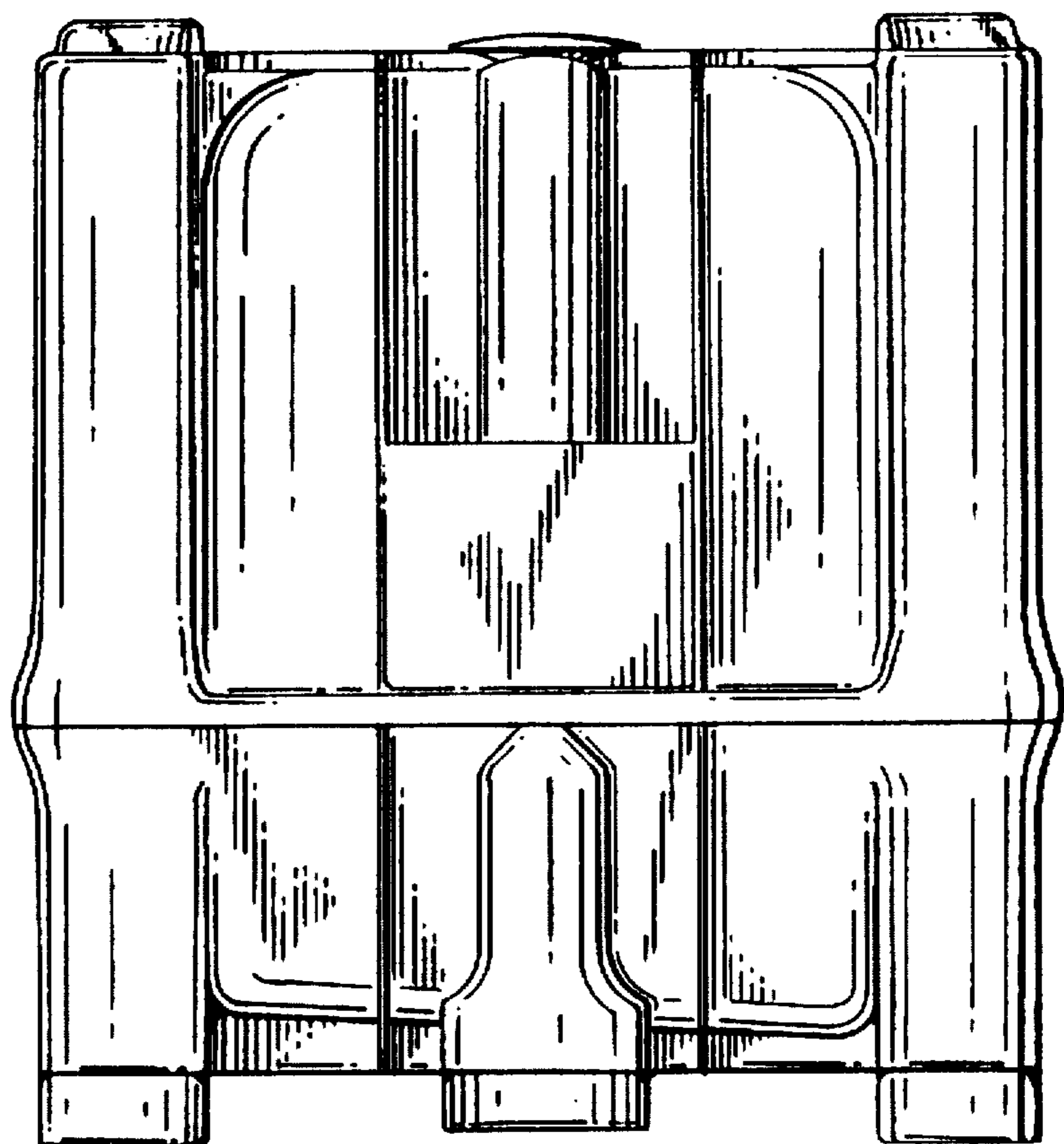
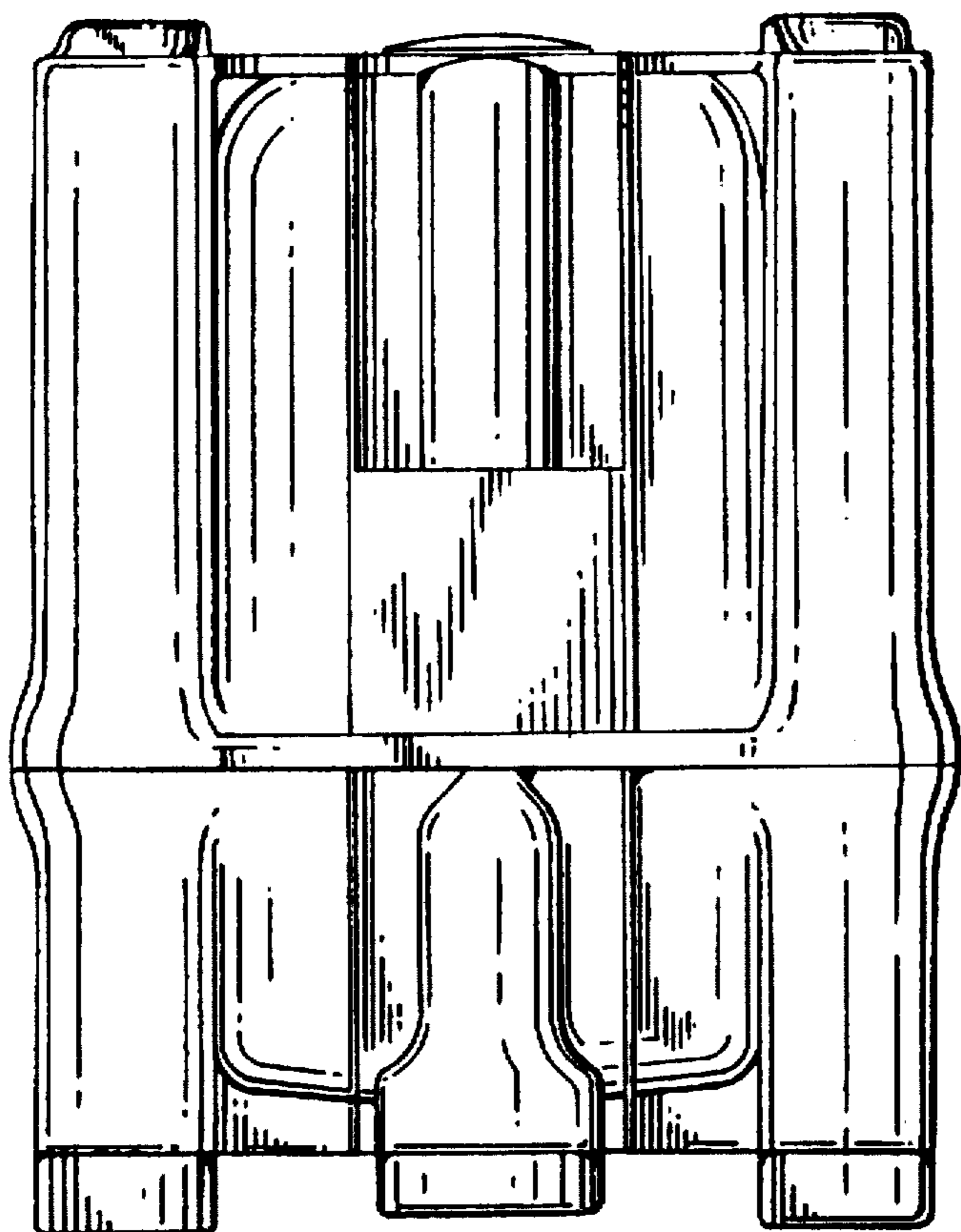
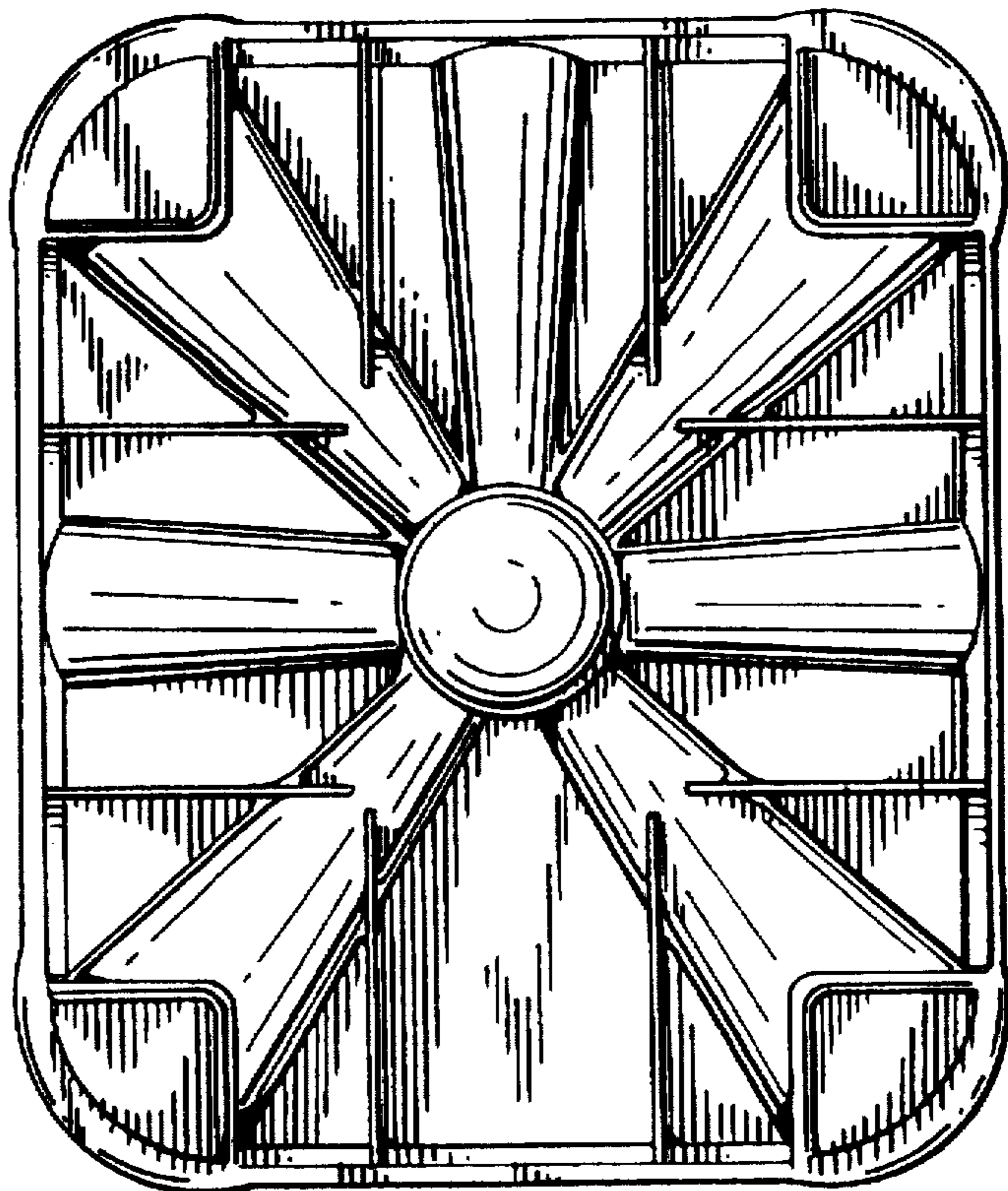

FIG. 3



*FIG. 4*



*FIG. 5*

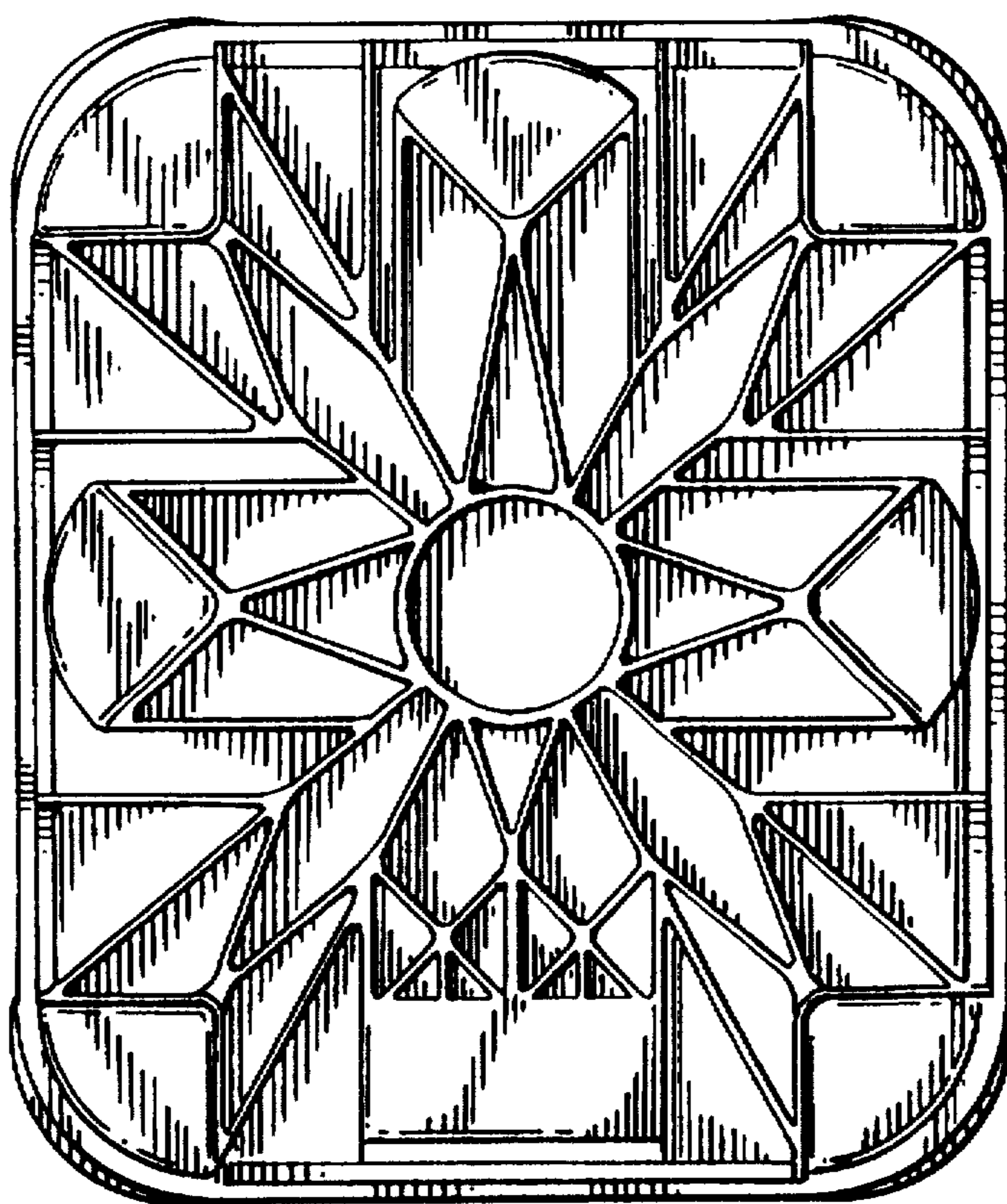

*FIG. 6*