



US00D394270S

United States Patent [19]
Strandell et al.

[11] **Patent Number: Des. 394,270**
[45] **Date of Patent: **May 12, 1998**

- [54] **ICE MACHINE**
- [75] **Inventors: Timothy B. Strandell, Racine; Raymond R. Haack, Mishicot, both of Wis.**
- [73] **Assignee: Manitowoc Foodservice Group, Inc., Sparks, Nev.**
- [**] **Term: 14 Years**
- [21] **Appl. No.: 69,754**
- [22] **Filed: Apr. 22, 1997**
- [51] **LOC (6) Cl. 15-07**
- [52] **U.S. Cl. D15/80**
- [58] **Field of Search D15/79-83, 89, D15/90; 62/246-254, 340, 344, 457.1-457.9**

D. 317,454 6/1991 Matsumura et al. D15/83
3,971,231 7/1976 Derry D15/81

Primary Examiner—Sandra L. Morris

[57] **CLAIM**

The ornamental design for an ice machine, as shown and described.

DESCRIPTION

FIG. 1 is a left, front perspective view of an ice machine showing the new design;
FIG. 2 is a left side elevational view thereof, the right side elevational view being a mirror image thereof;
FIG. 3 is a front elevational view thereof;
FIG. 4 is a rear elevational view thereof;
FIG. 5 is a top plan view thereof;
FIG. 6 is a bottom plan view thereof;
FIG. 7 is a right, front perspective view of a second embodiment of an ice machine showing the new design; and, FIG. 8 is a right, front perspective view of a third embodiment of an ice machine showing the new design.

[56] **References Cited**
U.S. PATENT DOCUMENTS

- D. 292,098 9/1987 Pandolfi D15/82
- D. 314,579 2/1991 Maxwell et al. D15/80

1 Claim, 4 Drawing Sheets

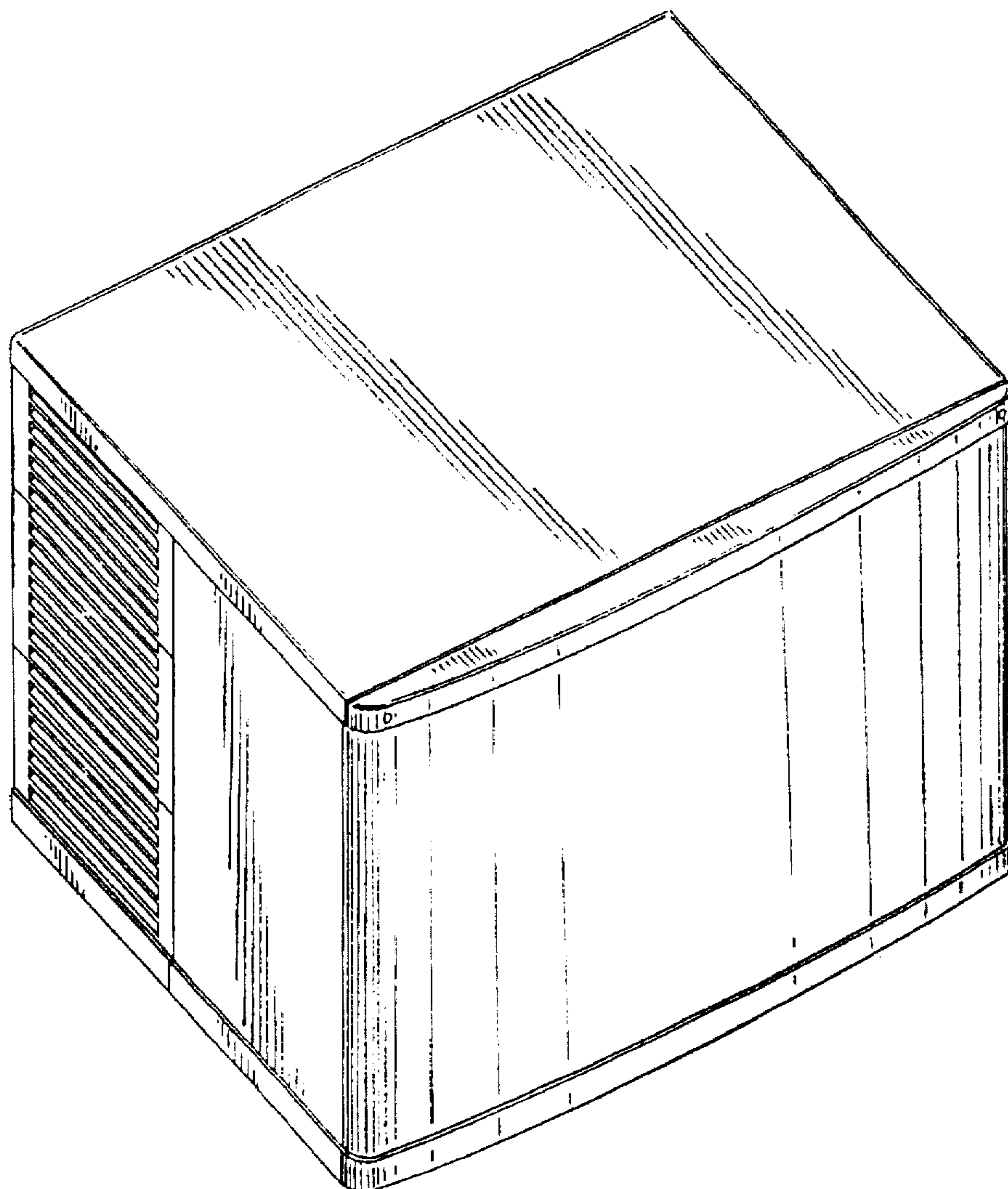

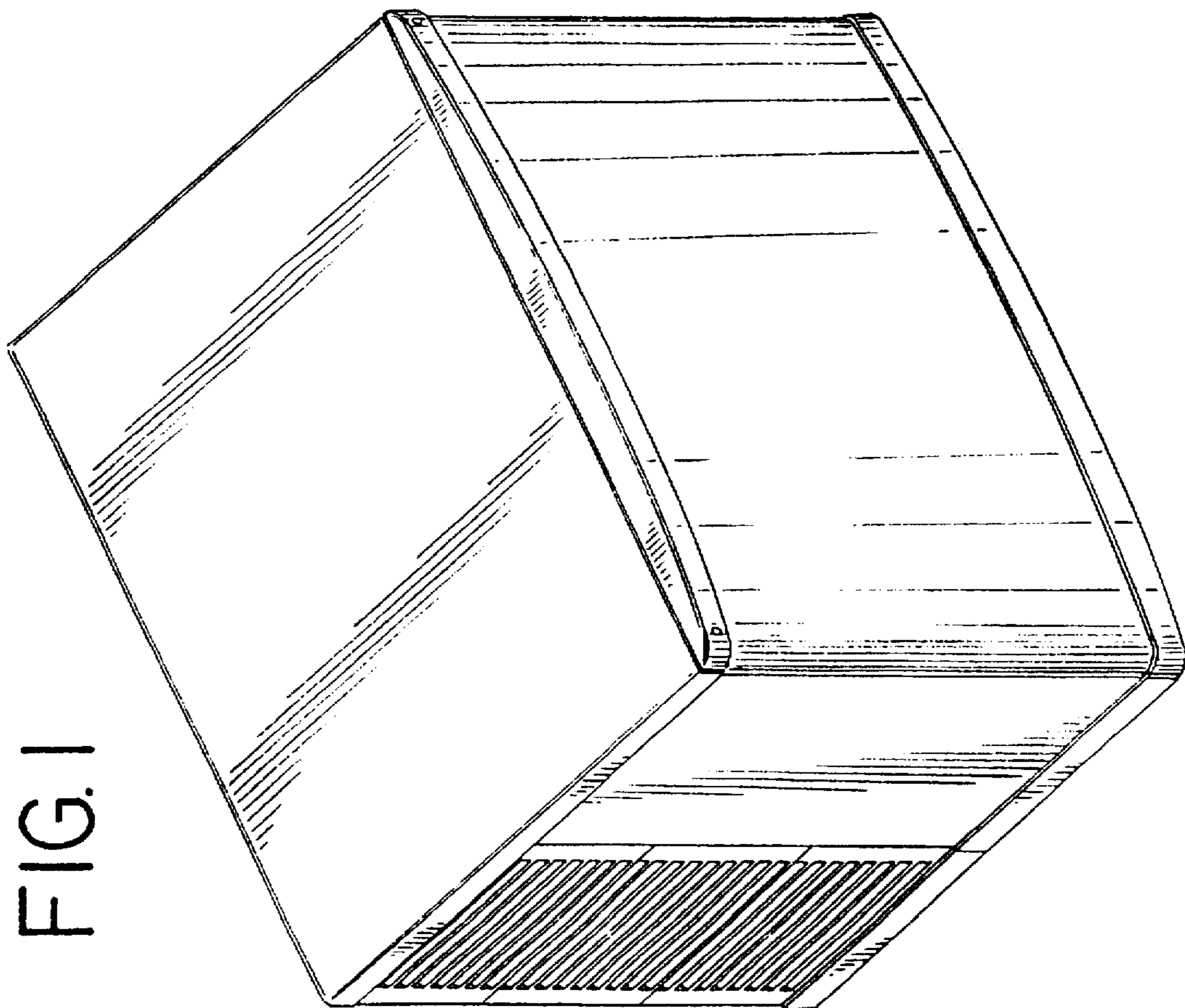

FIG. 2

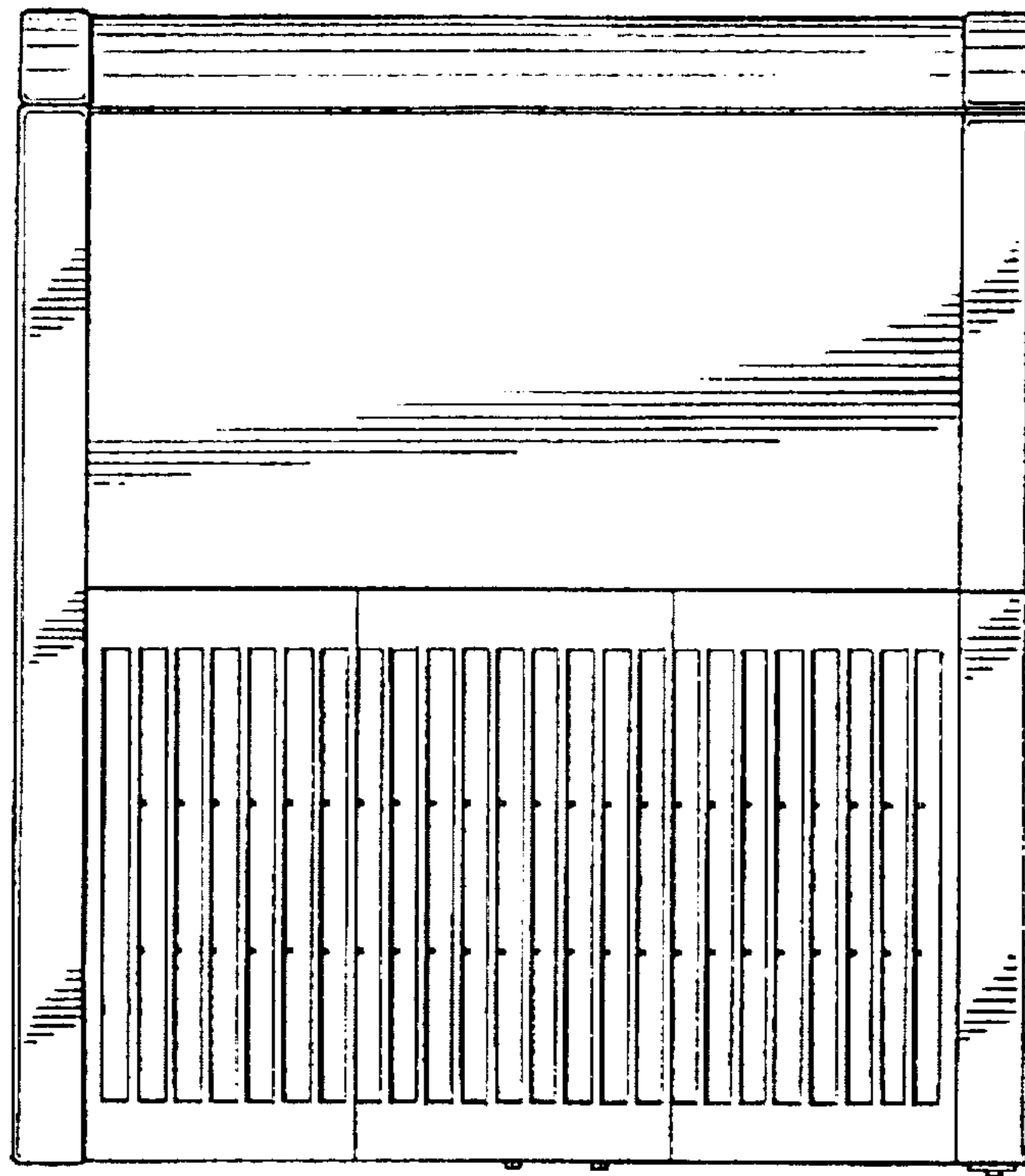

FIG. 3

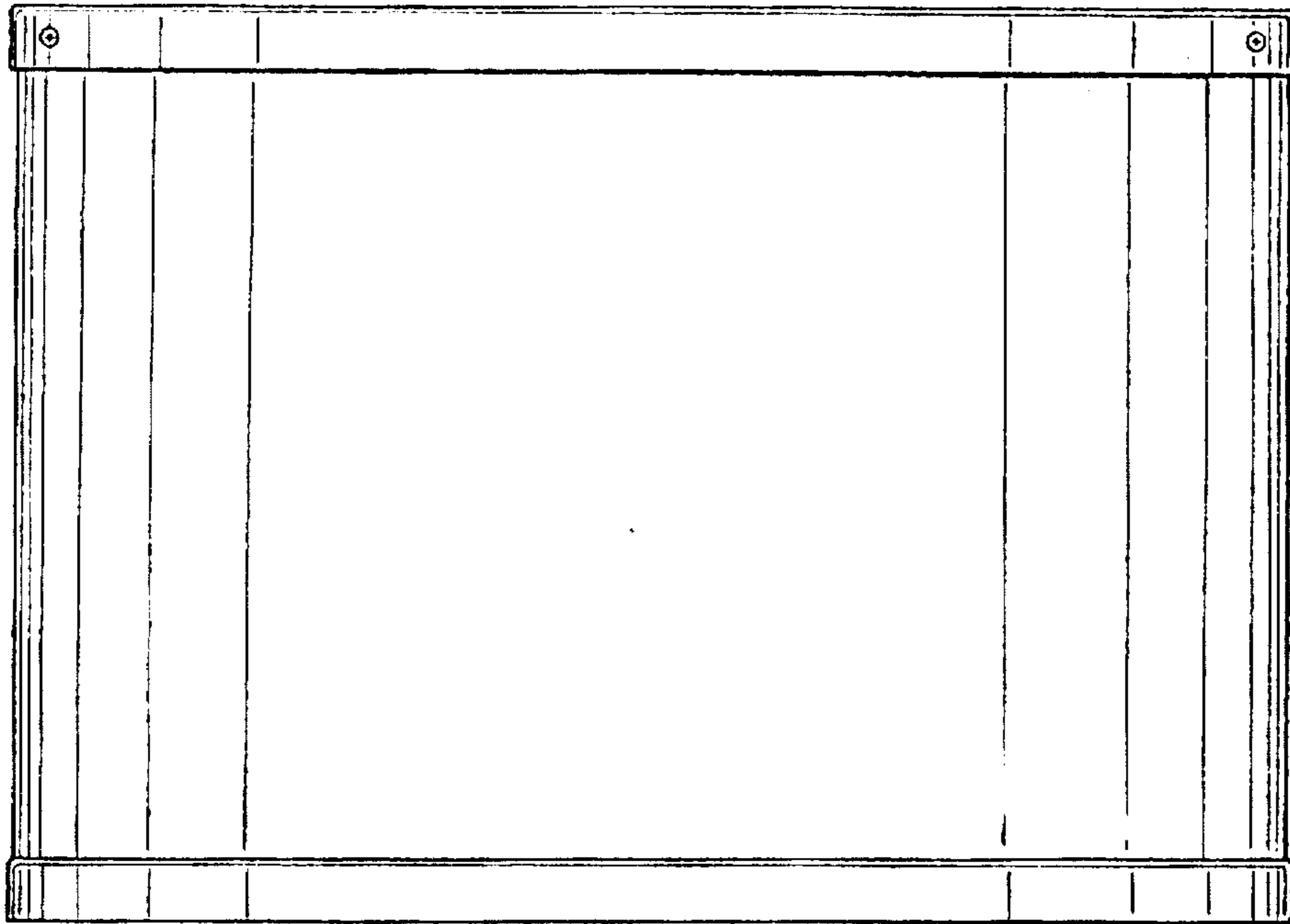

FIG. 4

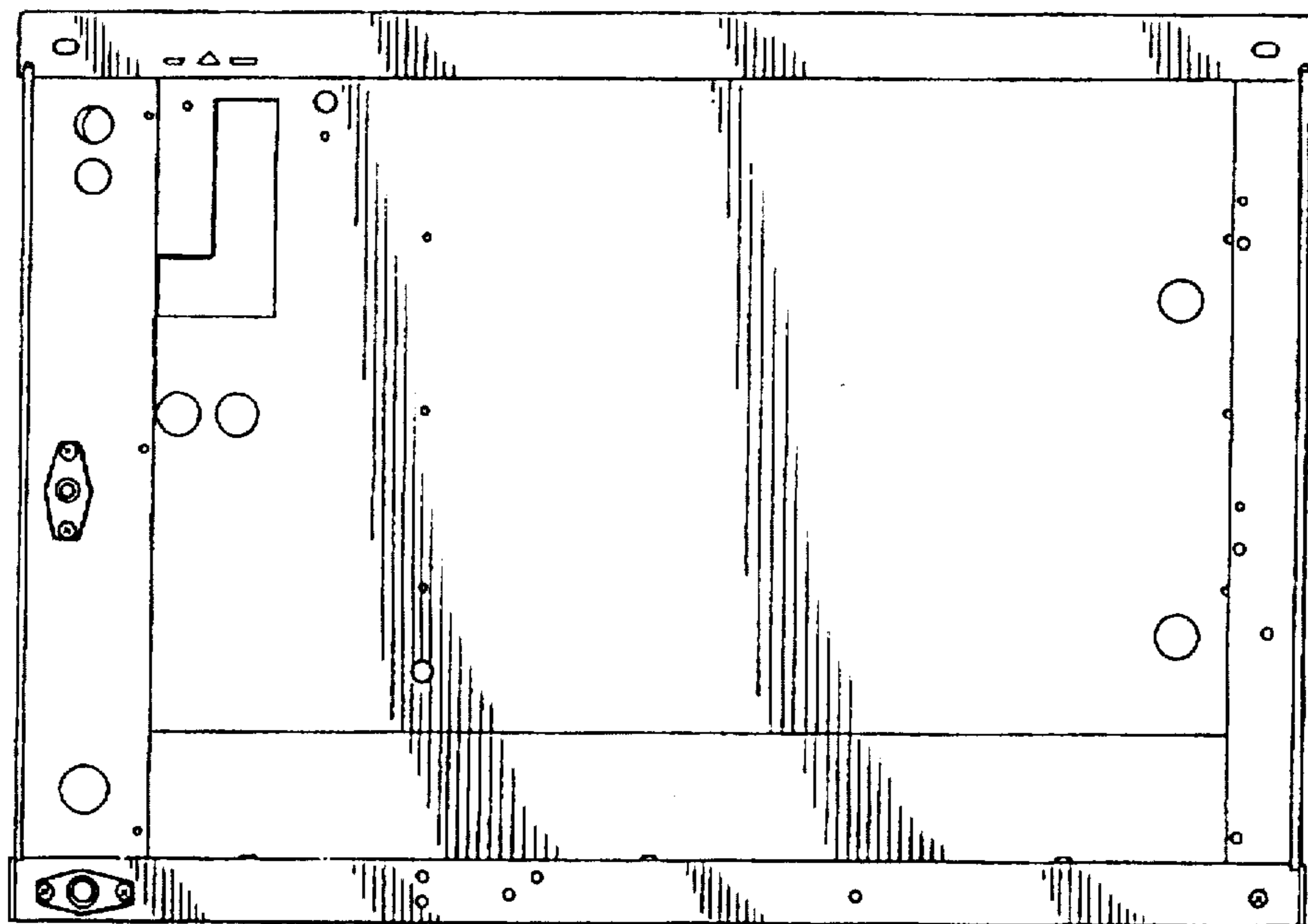

FIG. 5

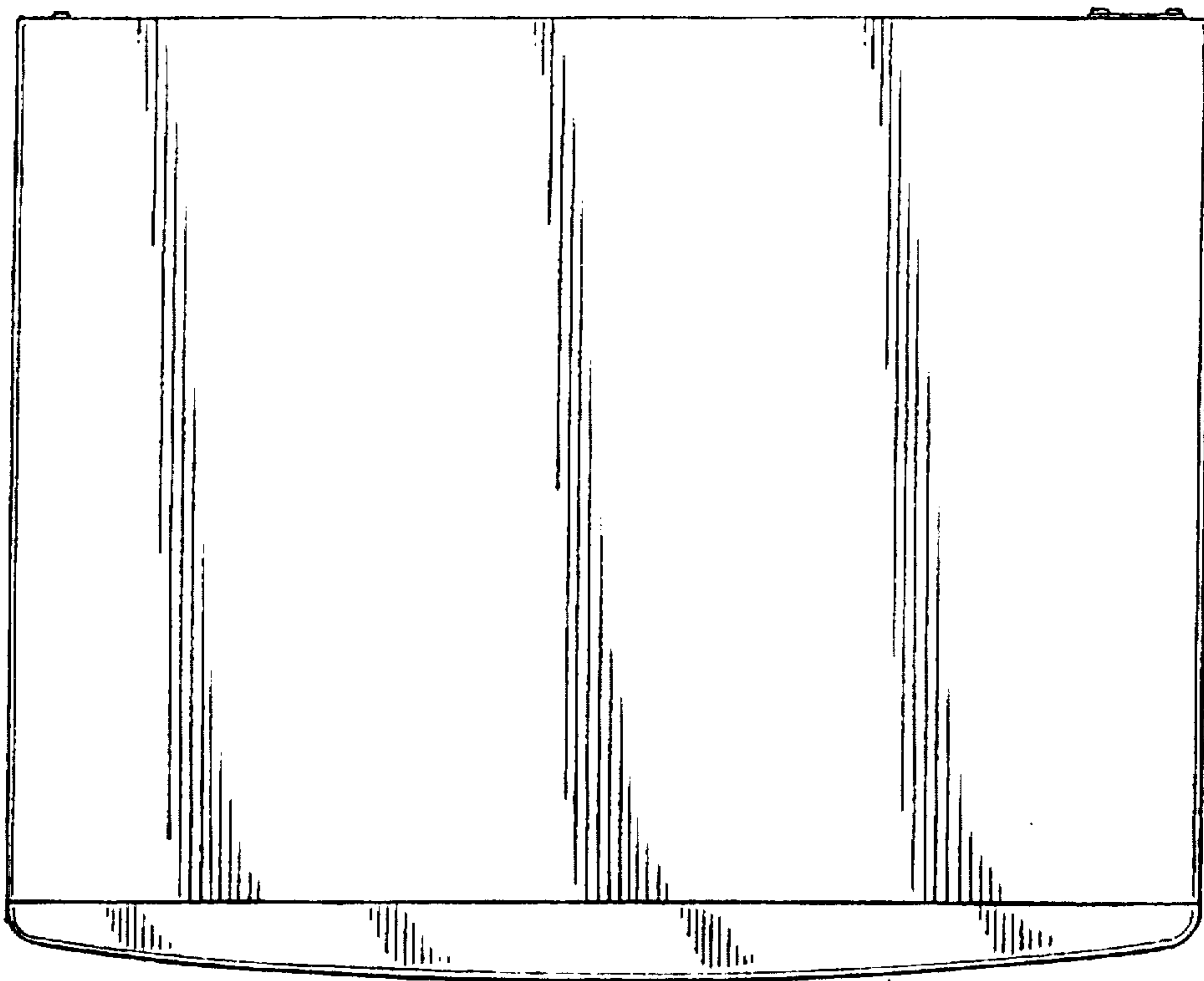

FIG. 6

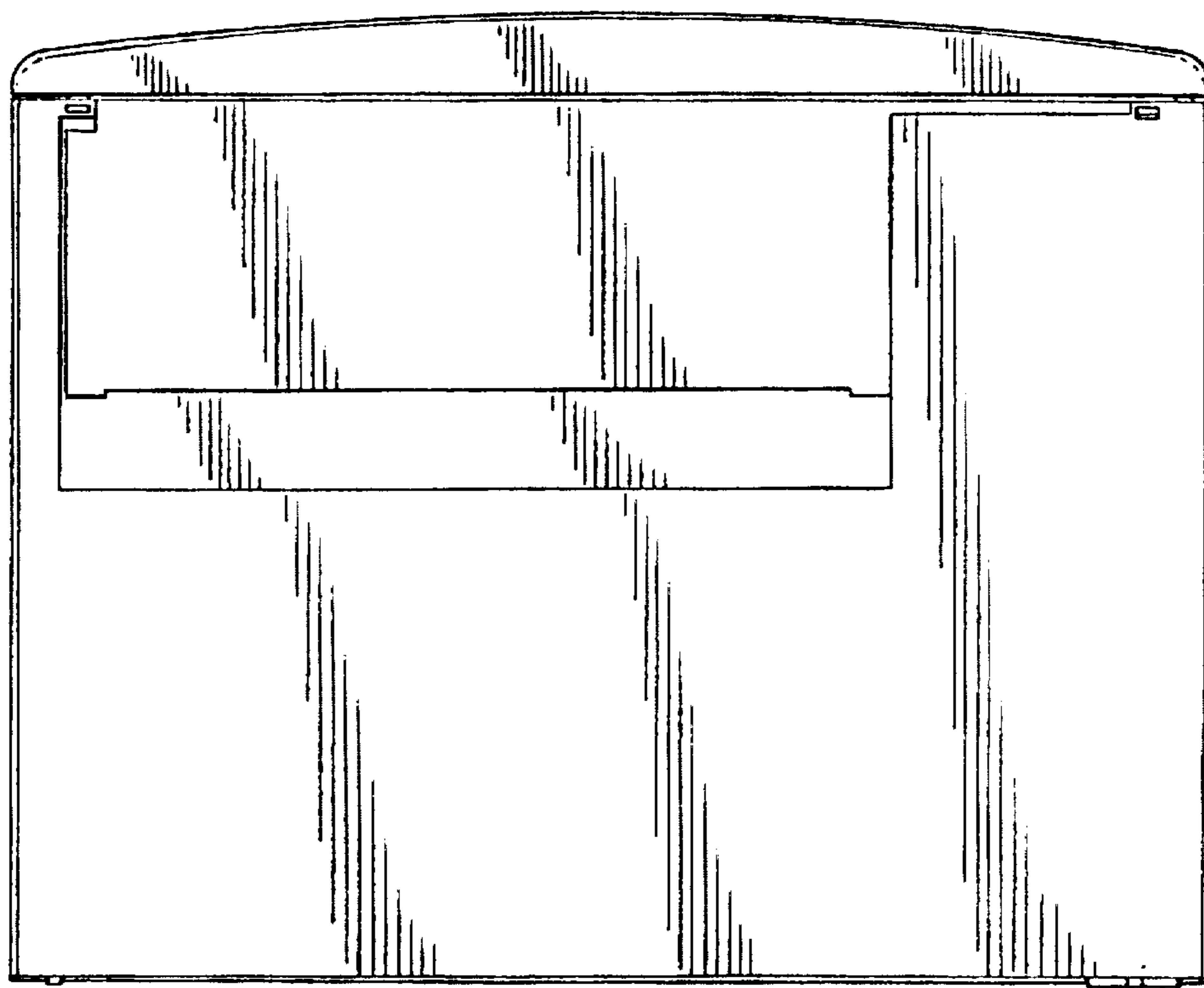

FIG. 7

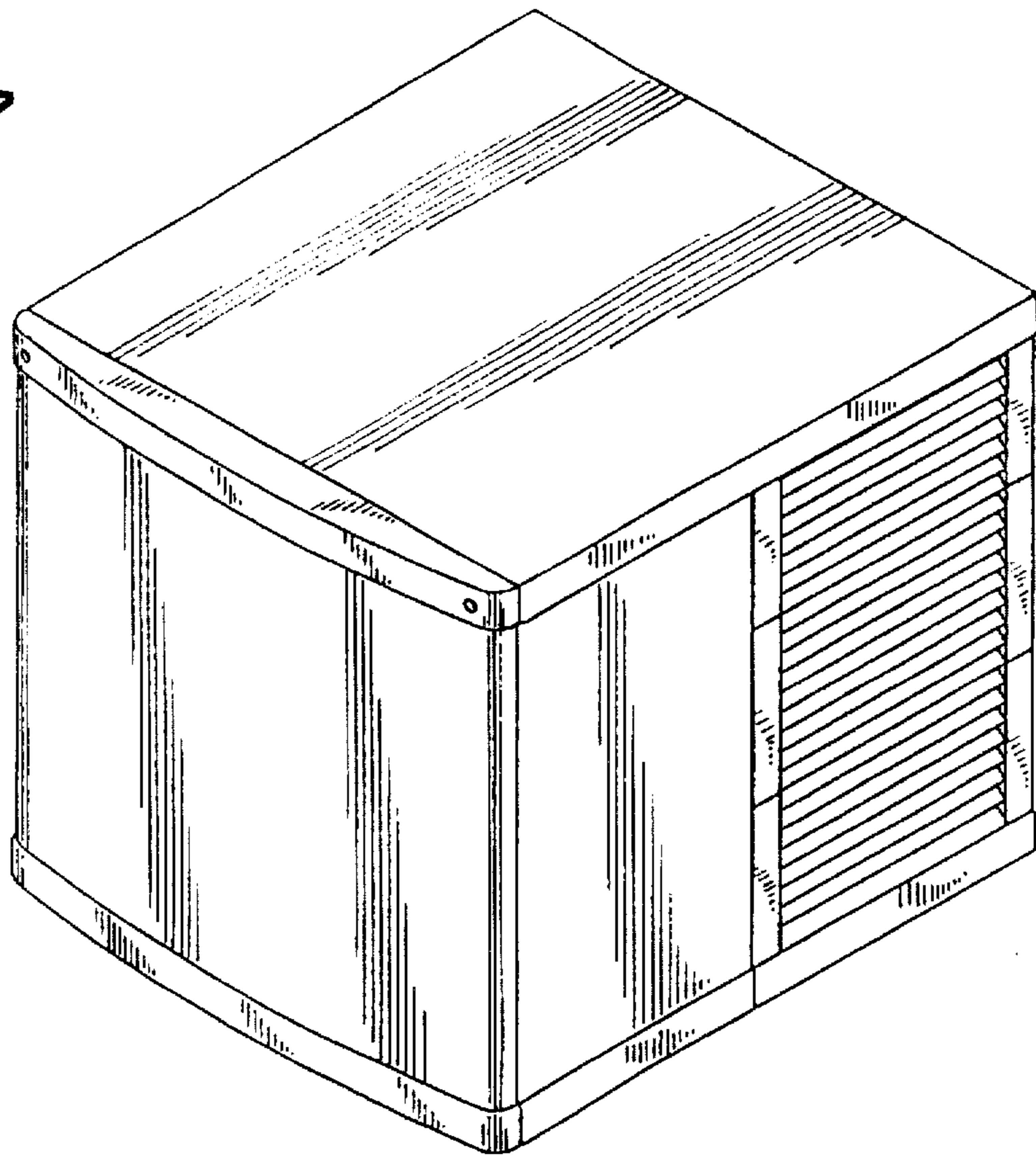

FIG. 8

