



US00D394198S

United States Patent [19]
Siler

[11] **Patent Number: Des. 394,198**
[45] **Date of Patent: **May 12, 1998**

[54] **AUTOMATED TELLER MACHINE
CASSETTE LOCK**

5,419,165 5/1995 Perkins 70/14

[76] **Inventor: Buzz Siler, 3328 Lakeview Bl., Lake
Oswego, Oreg. 97035**

Primary Examiner—Brian N. Vinson

[**] **Term: 14 Years**

[57] **CLAIM**

The ornamental design for an automated teller machine cassette lock, as shown and described.

[21] **Appl. No.: 64,031**

DESCRIPTION

[22] **Filed: Dec. 20, 1996**

[51] **LOC (6) Cl. 08-07**

[52] **U.S. Cl. D8/346**

[58] **Field of Search** D8/330, 331, 336,
D8/346; 70/14, 57, 63, 77, 78, 91, 101,
158, 163; 292/281, 288, 289, DIG. 11

FIG. 1 is a top, front, and left side perspective view of an automated teller machine cassette lock showing my new design, the broken-line disclosure being understood to form no part of the claimed design;
FIG. 2 is a top, rear, and right side perspective view thereof;
FIG. 3 is a top plan view thereof;
FIG. 4 is a bottom plan view thereof;
FIG. 5 is a front elevational view thereof;
FIG. 6 is a right side elevational view thereof;
FIG. 7 is a rear elevational view thereof; and,
FIG. 8 is a left side elevational view thereof.

[56] **References Cited**

U.S. PATENT DOCUMENTS

D. 315,666 3/1991 Pearson D8/336
D. 329,800 9/1992 Pearson D8/336
4,629,230 12/1986 Tegg 292/281

1 Claim, 2 Drawing Sheets

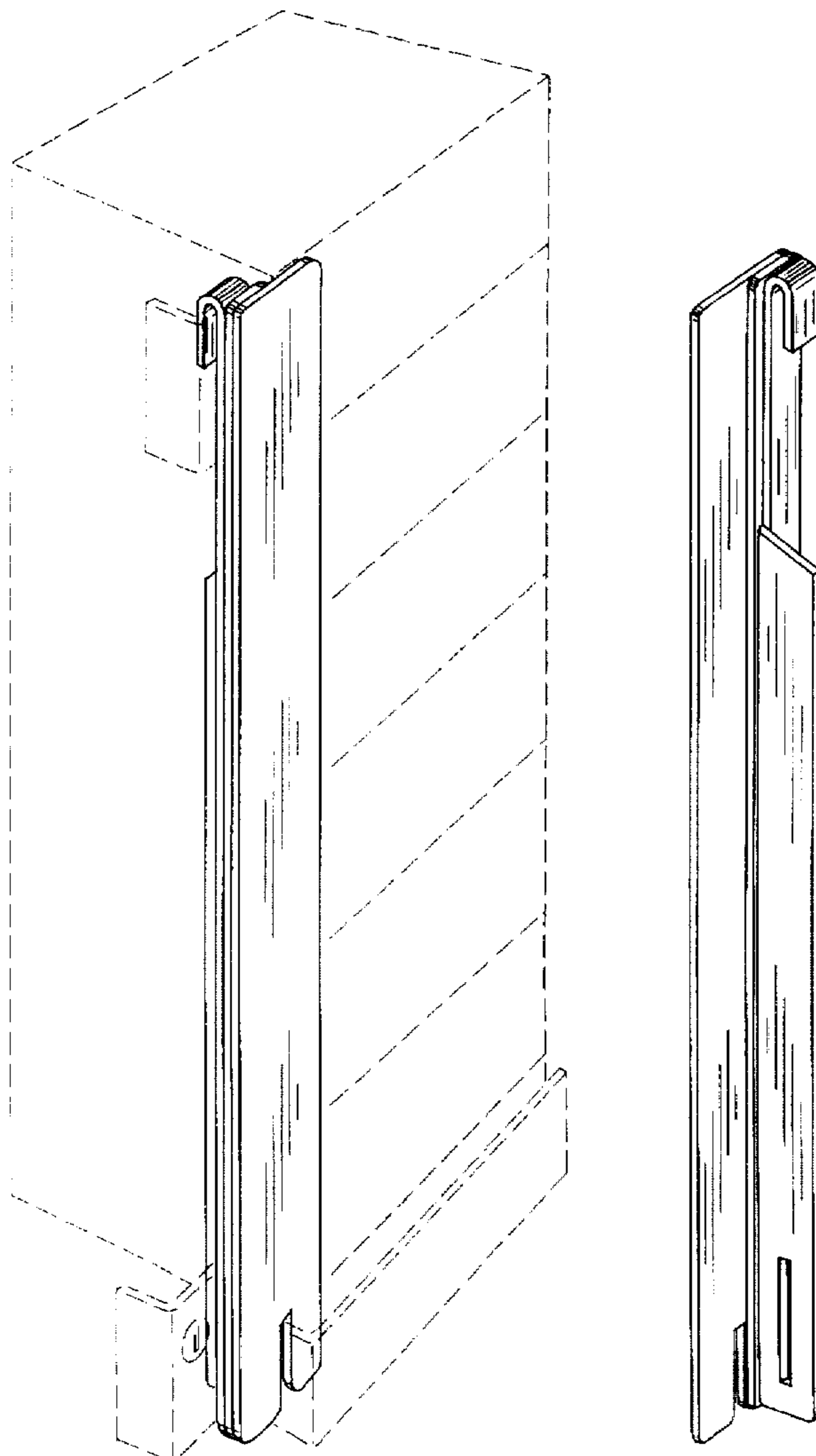

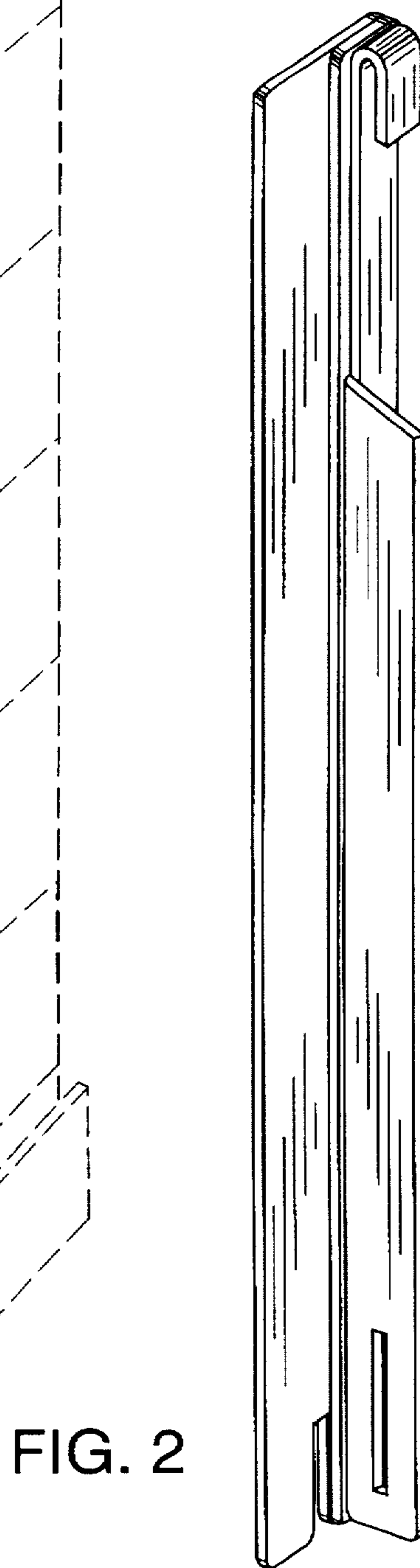
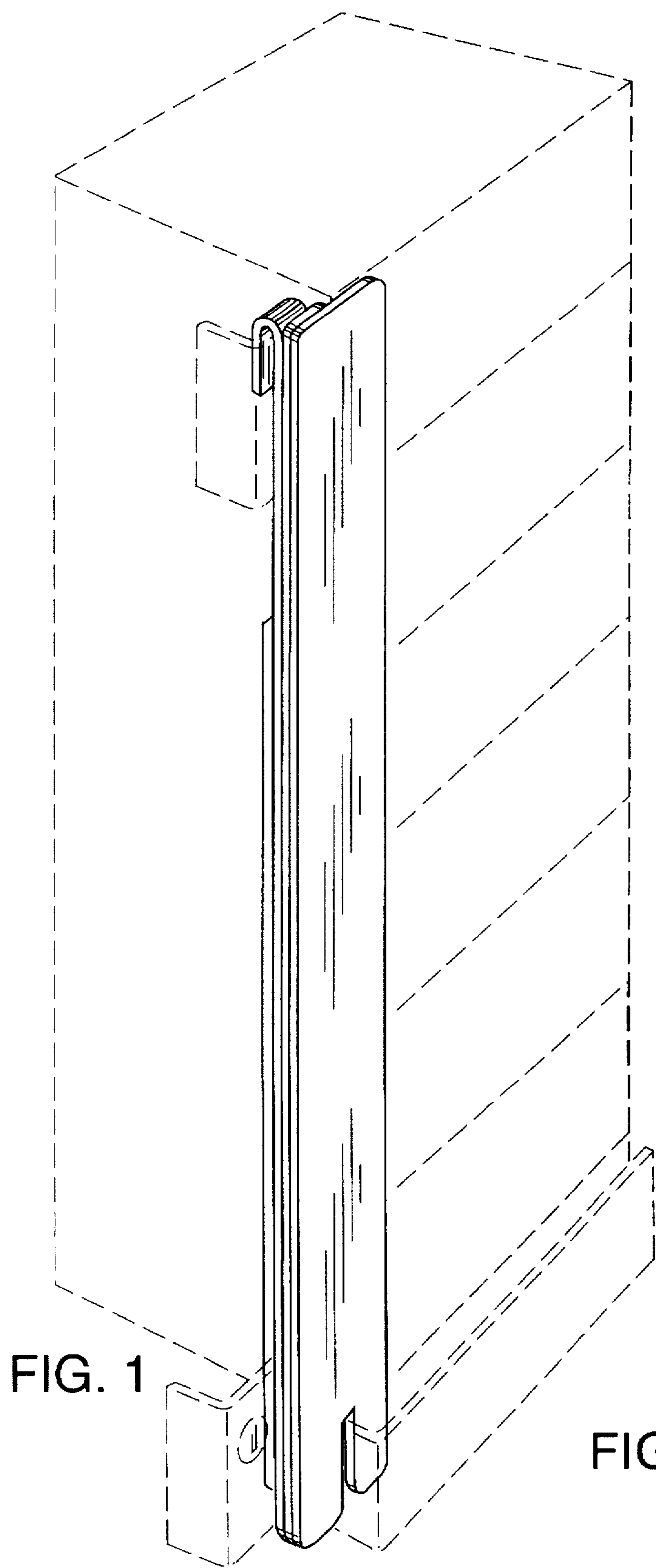

FIG. 3

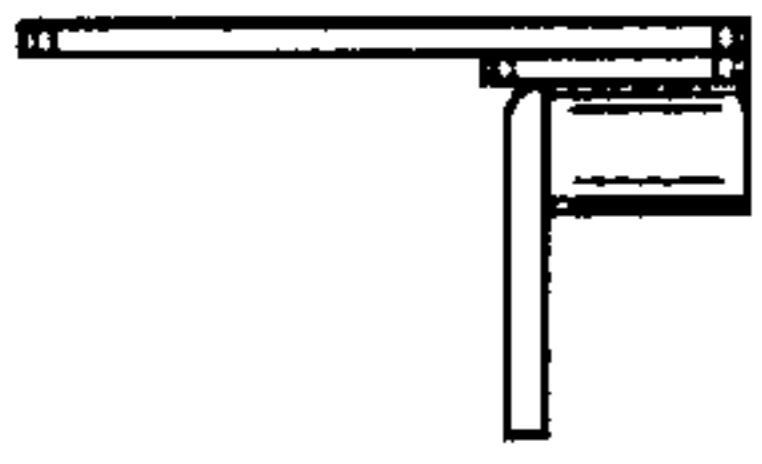

FIG. 4

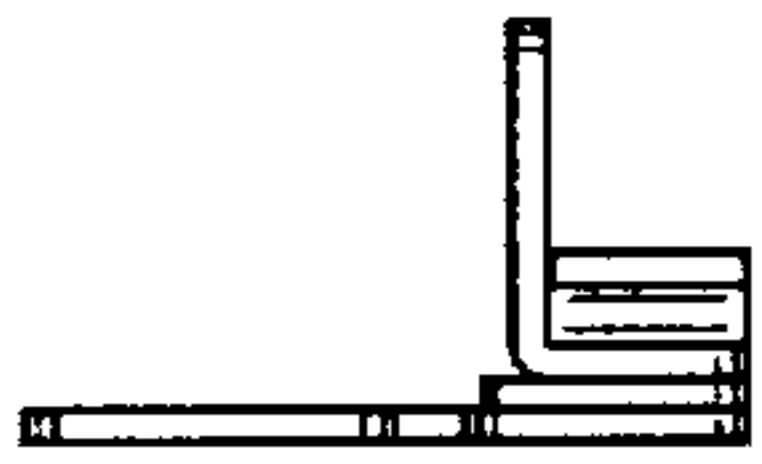

FIG. 5

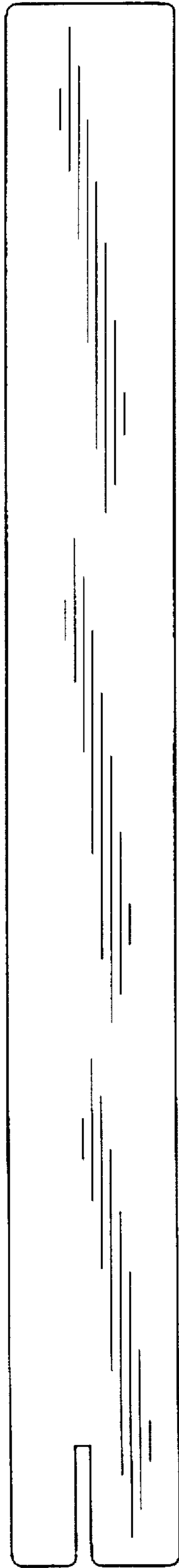

FIG. 6



FIG. 7

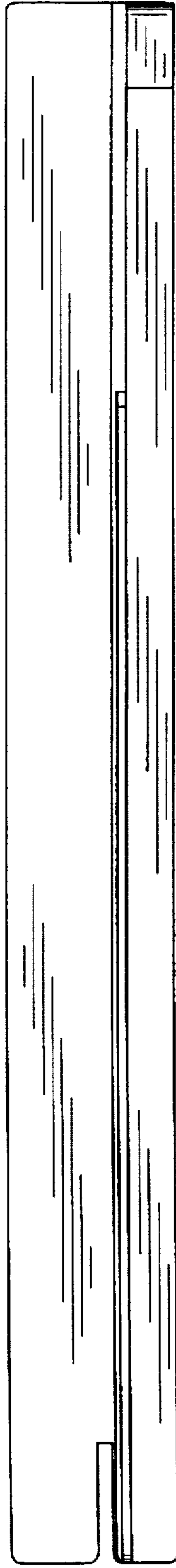

FIG. 8

