



US00D394169S

United States Patent [19]

Tisbo et al.

[11] Patent Number: **Des. 394,169**

[45] Date of Patent: ****May 12, 1998**

[54] **STORAGE LOCKER**

[75] Inventors: **Thomas A. Tisbo**, Barrington Hills;
Torrence Anderson; **Michael G. Uffner**, both of Naperville, all of Ill.

[73] Assignee: **Suncast Corporation**, Batavia, Ill.

[**] Term: **14 Years**

[21] Appl. No.: **64,079**

[22] Filed: **Nov. 11, 1996**

[51] LOC (6) Cl. **06-04**

[52] U.S. Cl. **D6/434**

[58] Field of Search D6/432-448; 312/204,
312/206, 257, 283, 215

[56] **References Cited**

U.S. PATENT DOCUMENTS

- D. 327,793 7/1992 McGrory D6/448
- D. 352,660 11/1994 Stribak D6/432 X
- D. 359,402 6/1995 Tisbo et al. D6/434

- D. 359,403 6/1995 Tisbo et al. D6/434
- D. 363,175 10/1995 Tisbo et al. D6/434
- D. 366,376 1/1996 Tisbo et al. D6/434
- D. 366,577 1/1996 Tisbo et al. D6/434
- D. 367,189 2/1996 Tisbo et al. D6/434

Primary Examiner—Carmen H. Vales-Lado
Attorney, Agent, or Firm—McHale & Slavin

[57] **CLAIM**

The ornamental design for a storage locker, as shown and described.

DESCRIPTION

FIG. 1 is a front elevational view of a storage locker showing our new design;
FIG. 2 is a right side elevational view thereof;
FIG. 3 is a left side elevational view thereof;
FIG. 4 is a rear elevational view thereof;
FIG. 5 is a top plan view thereof;
FIG. 6 is a bottom plan view thereof; and,
FIG. 7 is a perspective view thereof.

1 Claim, 2 Drawing Sheets

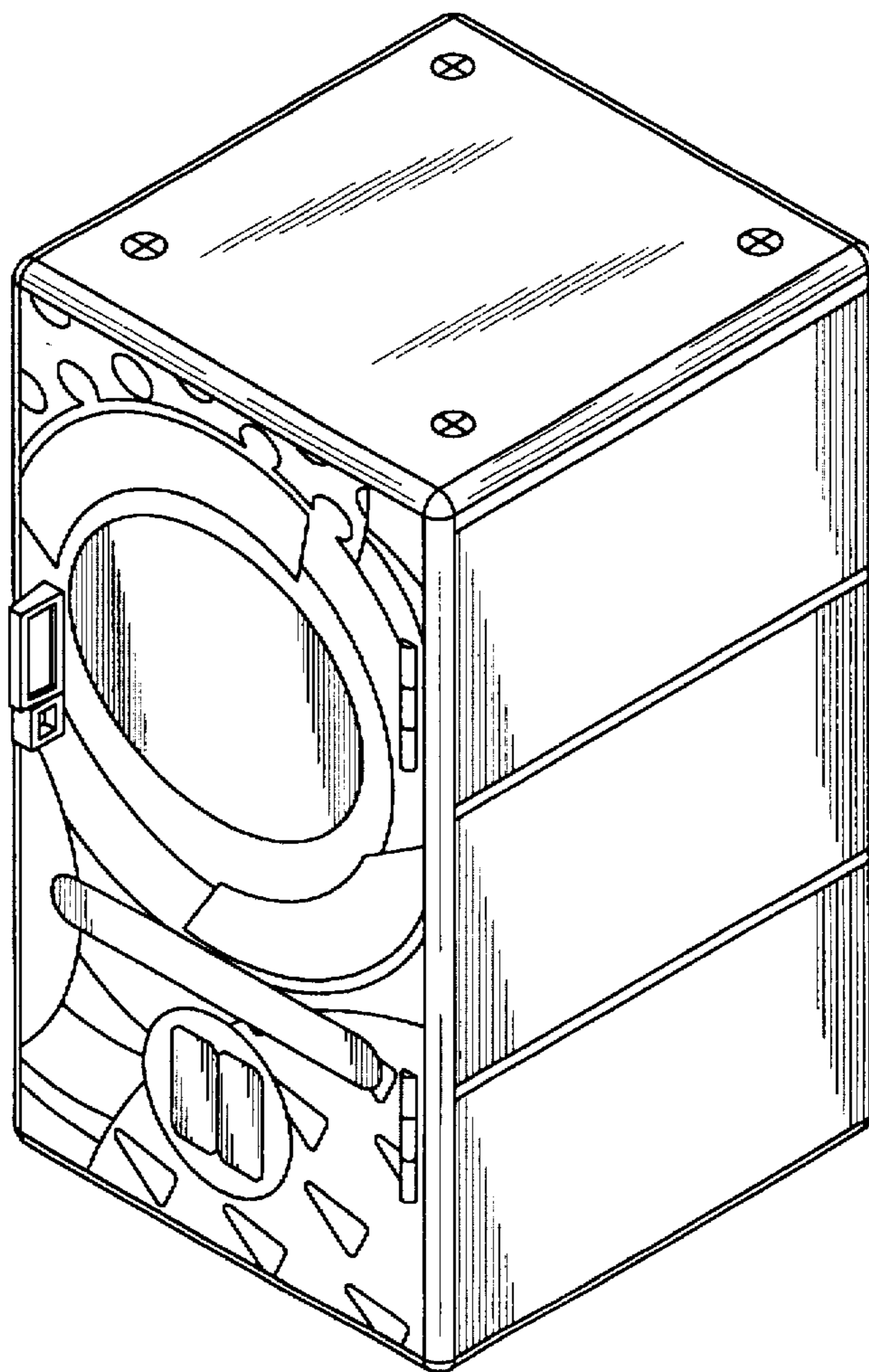

FIG. 1

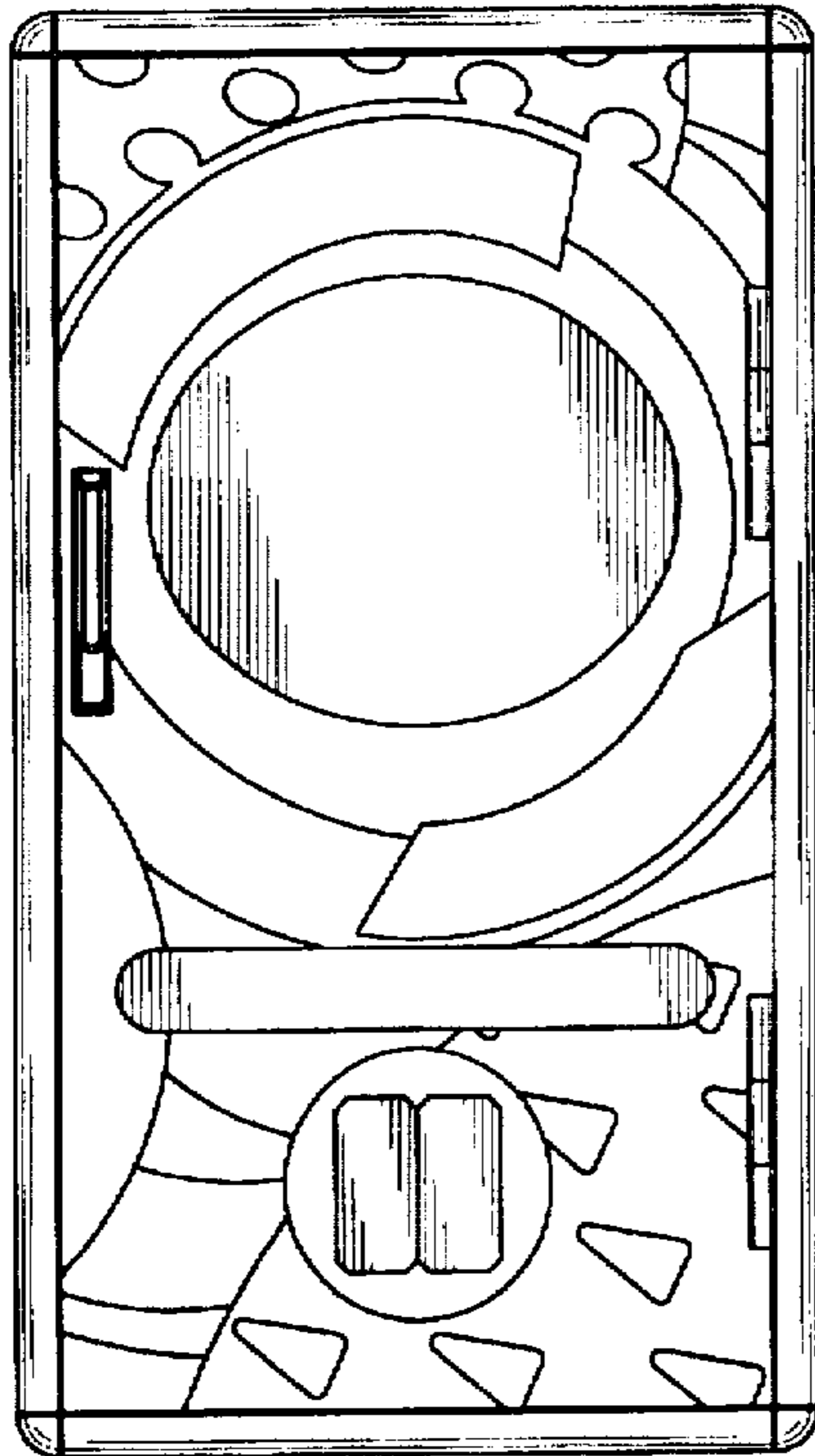

FIG. 2

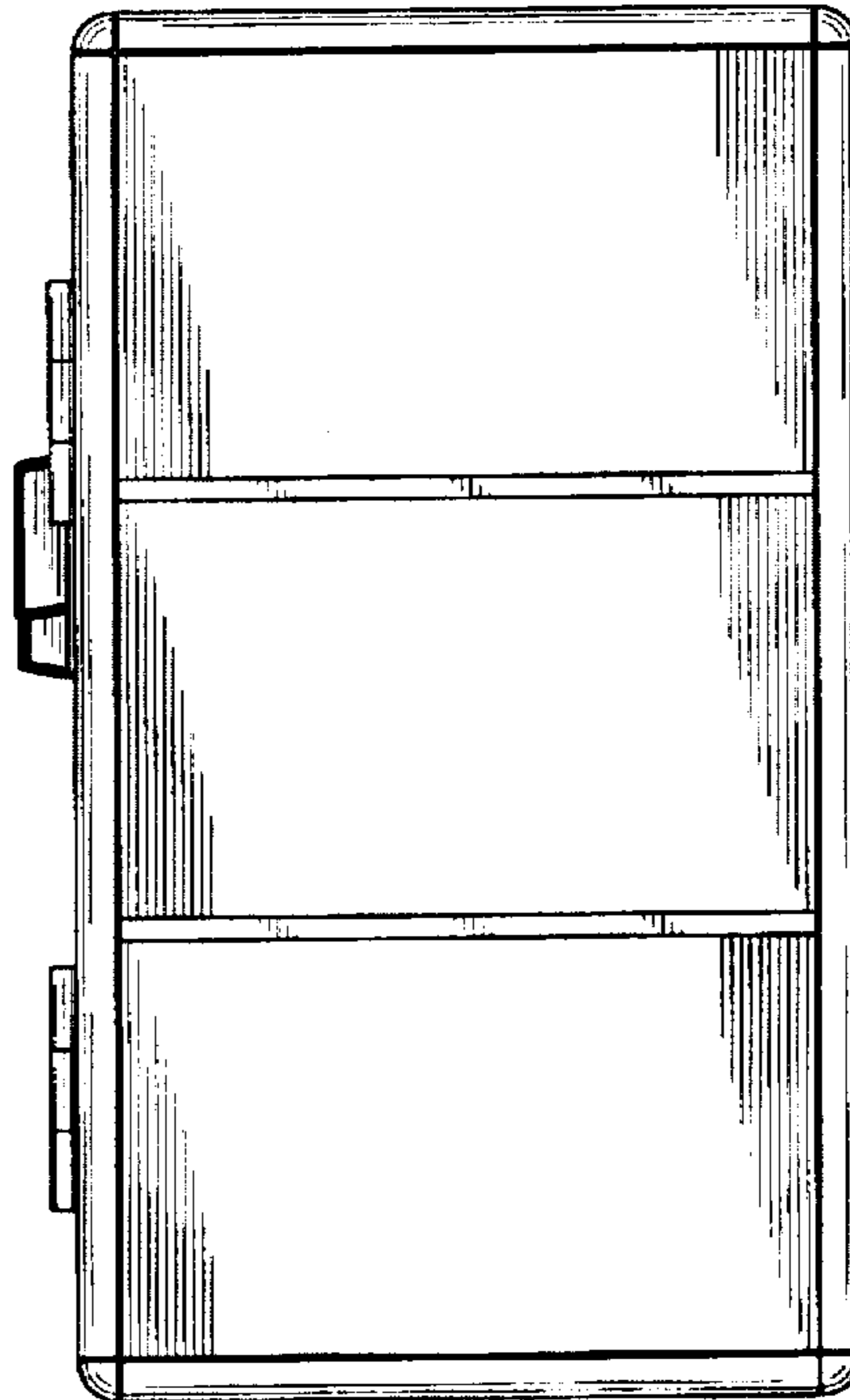

FIG. 3

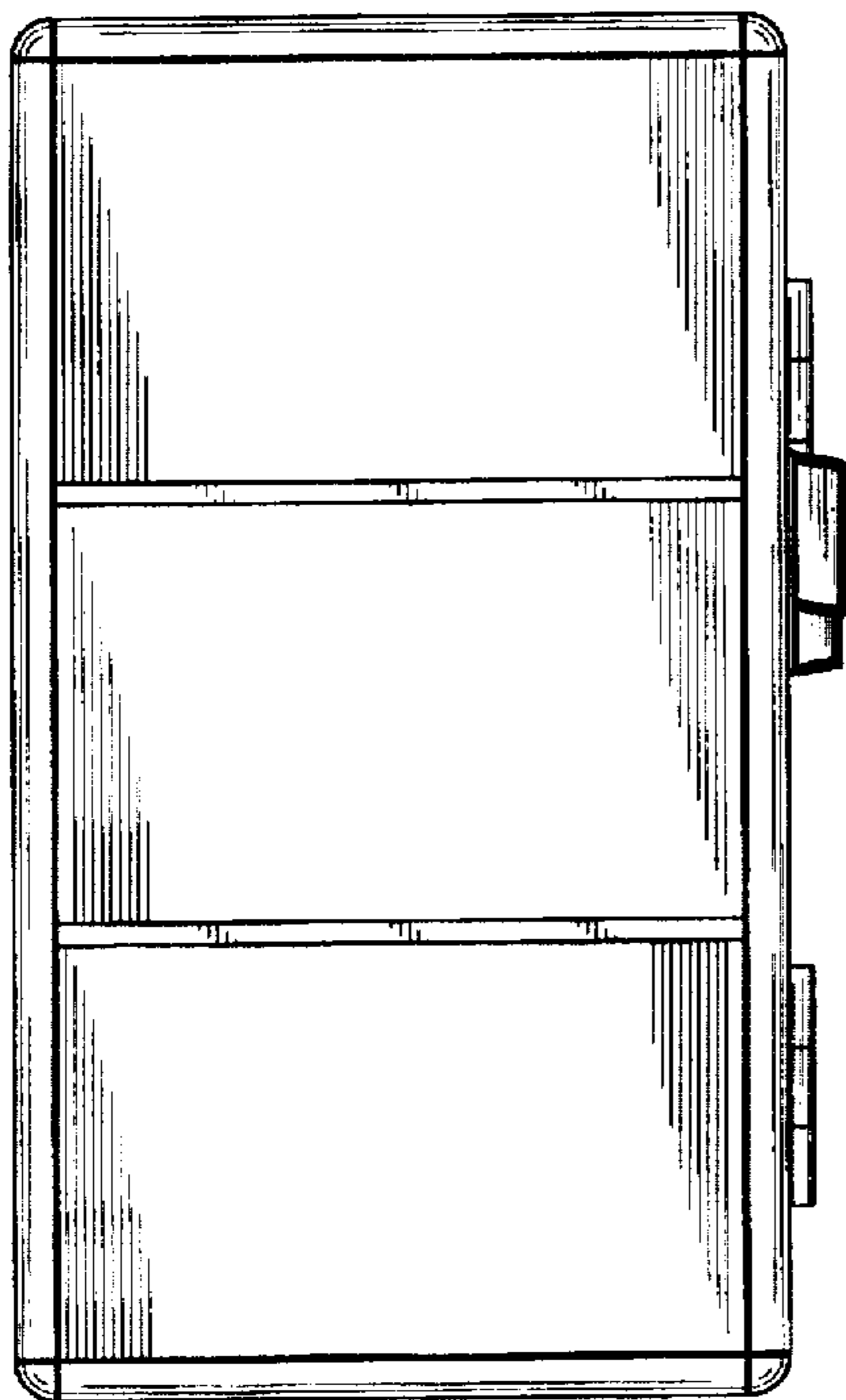

FIG. 4

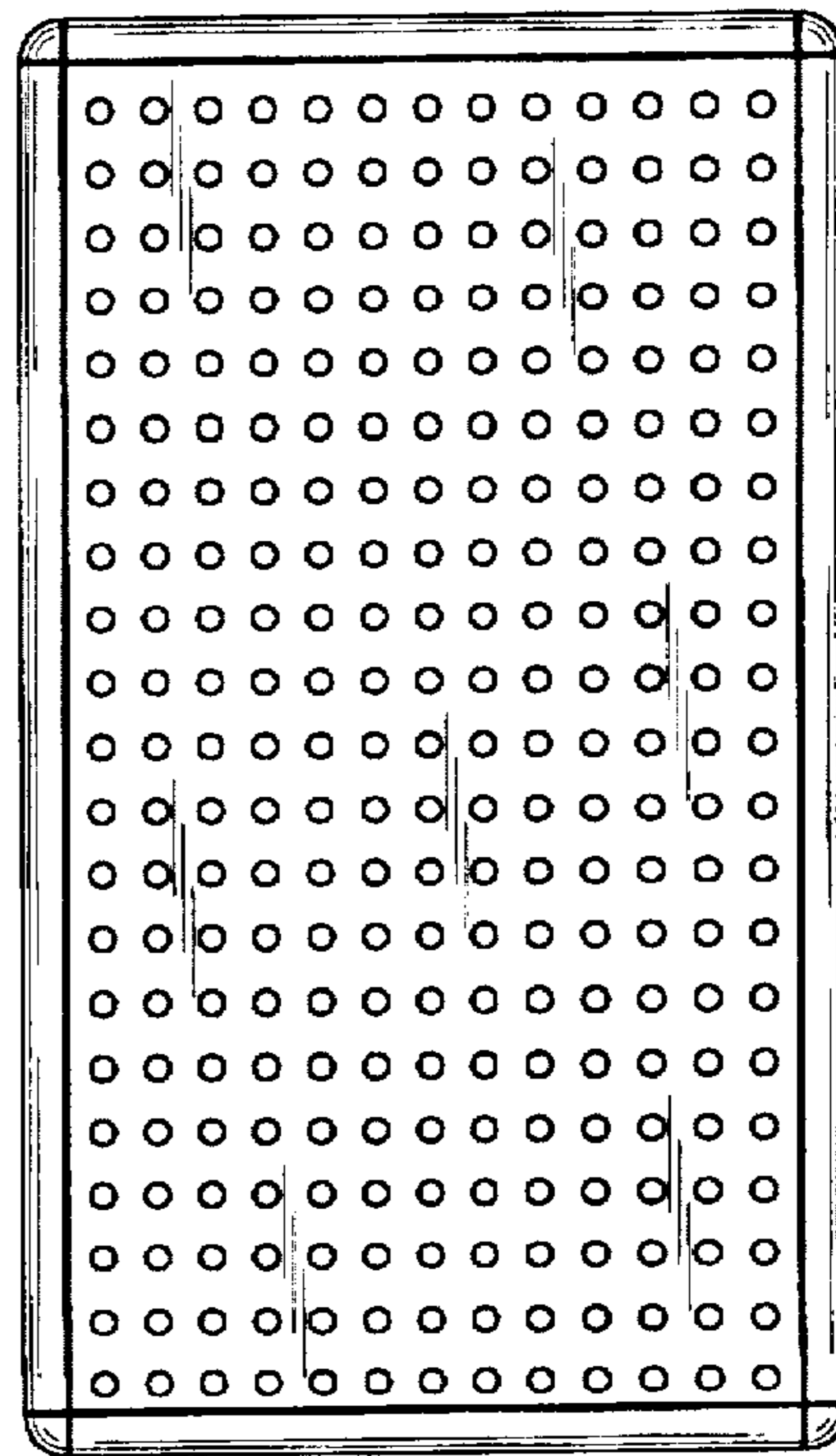

FIG. 5

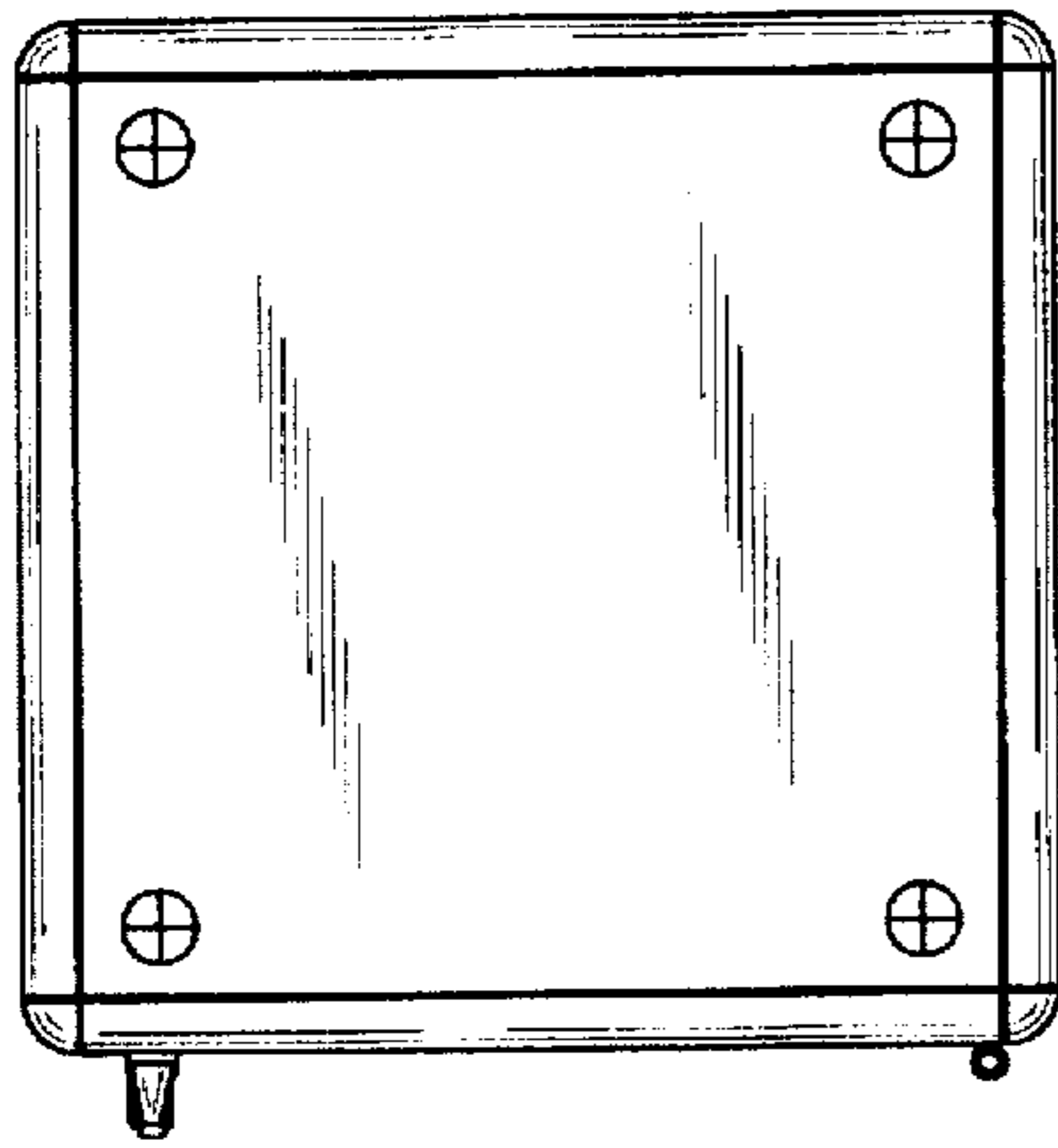

FIG. 6

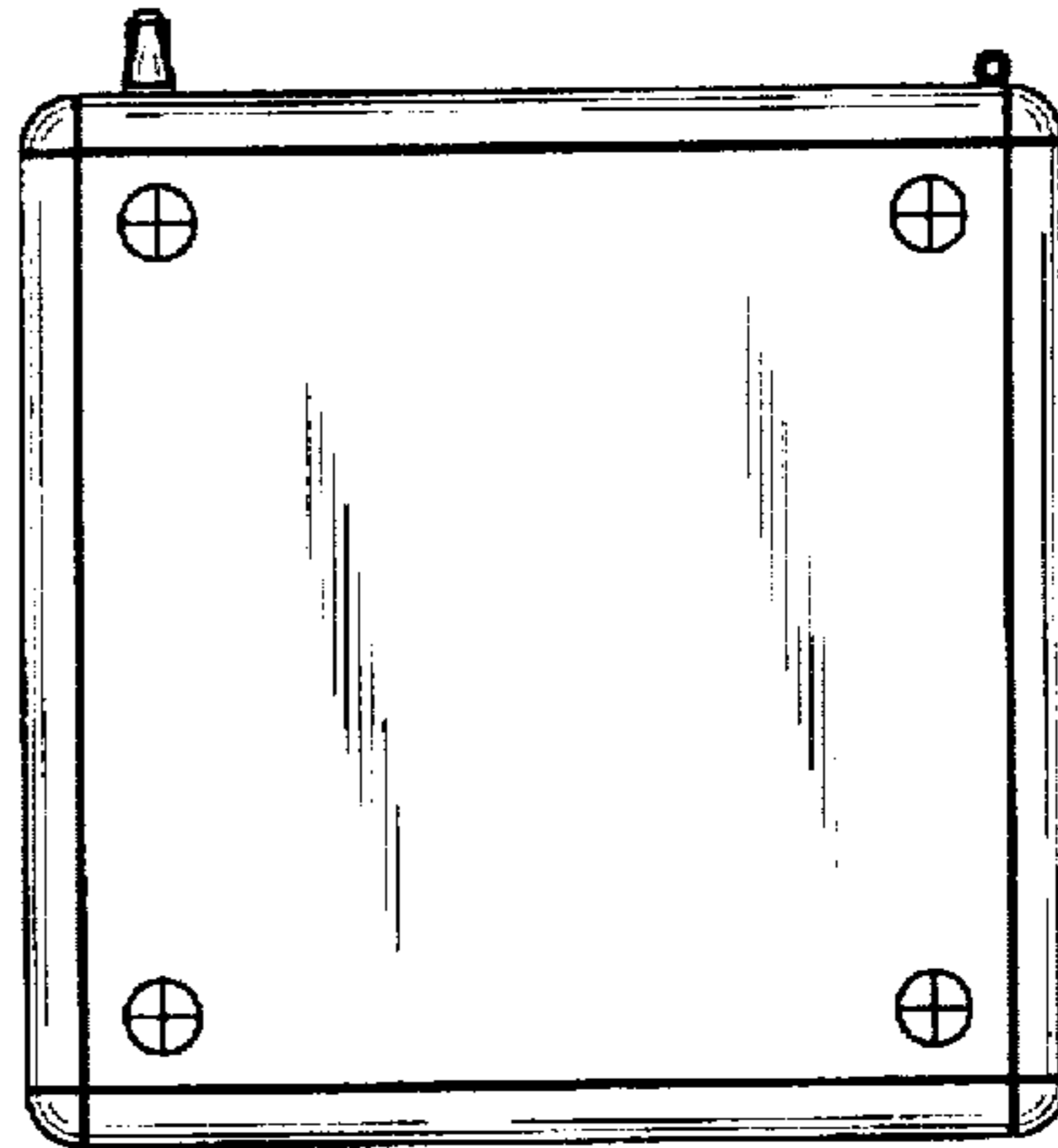

FIG. 7

