



US00D394157S

# United States Patent [19]

Dickinson et al.

[11] Patent Number: **Des. 394,157**

[45] Date of Patent: **\*\*May 12, 1998**

[54] **STORAGE CONTAINER HANDLE**

[75] Inventors: **Thomas Dickinson; Bradley D. Gale,**  
both of St. Louis, Mo.

[73] Assignee: **Contico International, Inc.,** St. Louis,  
Mo.

[\*\*] Term: **14 Years**

[21] Appl. No.: **49,614**

[22] Filed: **Jan. 2, 1996**

### Related U.S. Application Data

[63] Continuation of Ser. No. 36,590, Mar. 23, 1995, abandoned.

[51] LOC (6) Cl. .... **03-01**

[52] U.S. Cl. .... **D3/318; D8/306**

[58] Field of Search ..... **D3/318, 276, 327,**  
**D3/328, 275, 274, 281, 282; 16/126, 127;**  
**190/115, 57; D8/306, 316, 319, 320**

[56] **References Cited**

#### U.S. PATENT DOCUMENTS

- D. 188,523 8/1960 Finkelstein ..... D8/306
- D. 220,819 5/1971 Laurita ..... D8/306

- D. 248,821 8/1978 Poe ..... D8/306
- D. 301,201 5/1989 King ..... D8/306
- D. 319,962 9/1991 Cousins ..... D8/306
- D. 335,810 5/1993 Asien ..... D8/306
- D. 353,488 12/1994 Lin ..... D3/276
- 4,340,990 7/1982 Seynhæve ..... 190/115
- 4,364,150 12/1982 Remington ..... 190/115
- 5,012,553 5/1991 Hardigg et al. .... 16/126

*Primary Examiner*—Philip S. Hyder  
*Attorney, Agent, or Firm*—Howell & Haferkamp, L.C.

[57] **CLAIM**

The ornamental design for a storage container handle, as shown and described.

### DESCRIPTION

FIG. 1 is an orthographic projection view of a storage container handle showing our new design, the broken line showing of the storage container being for illustrative purposes only and forming no part of the claimed design; FIG. 2 is a front elevation view thereof; FIG. 3 is a right side elevation view thereof, the left side elevation view being a mirror image thereof; FIG. 4 is a top plan view thereof; FIG. 5 is a rear elevation view thereof; and, FIG. 6 is a bottom plan view thereof.

**1 Claim, 3 Drawing Sheets**

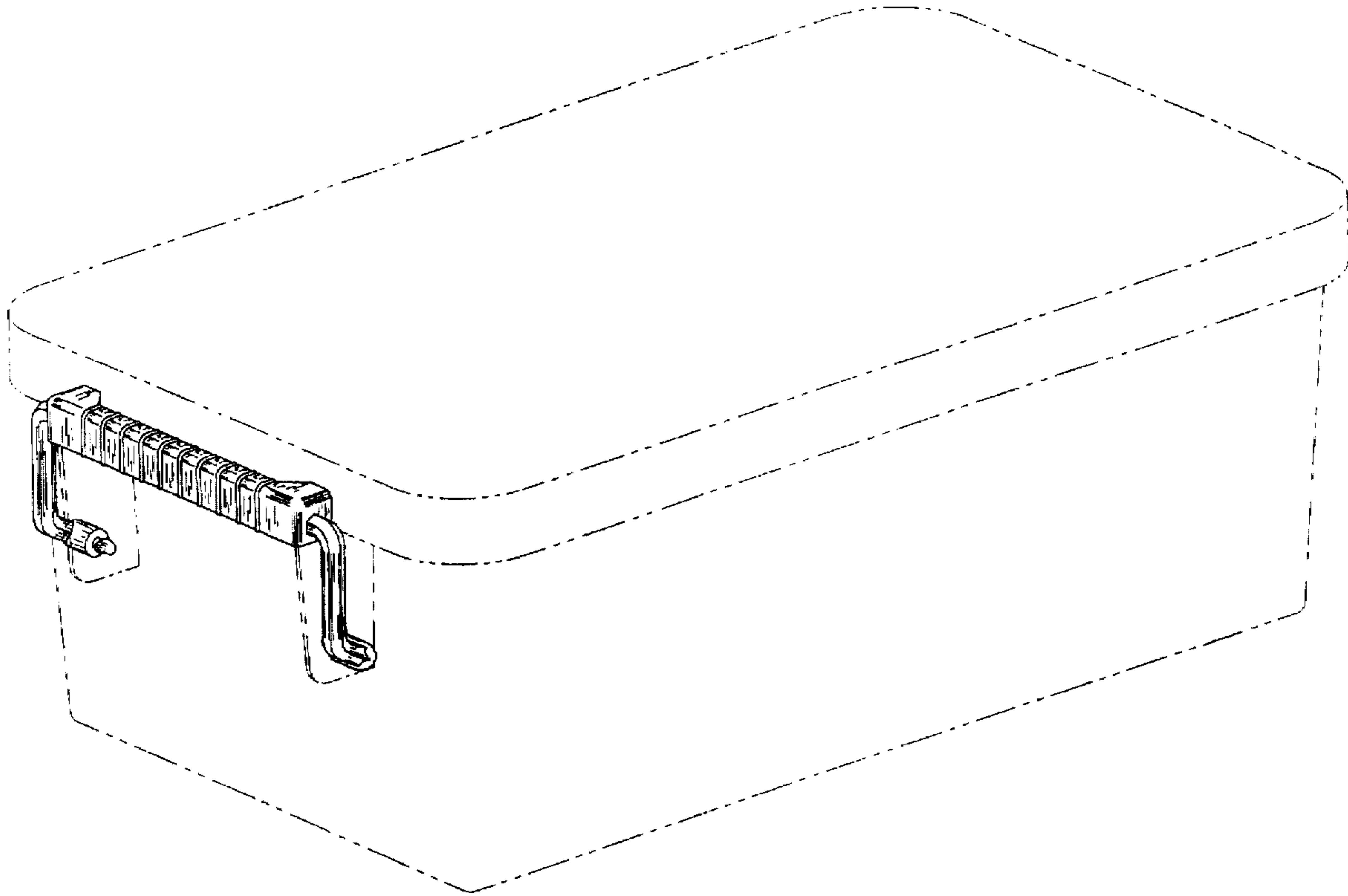

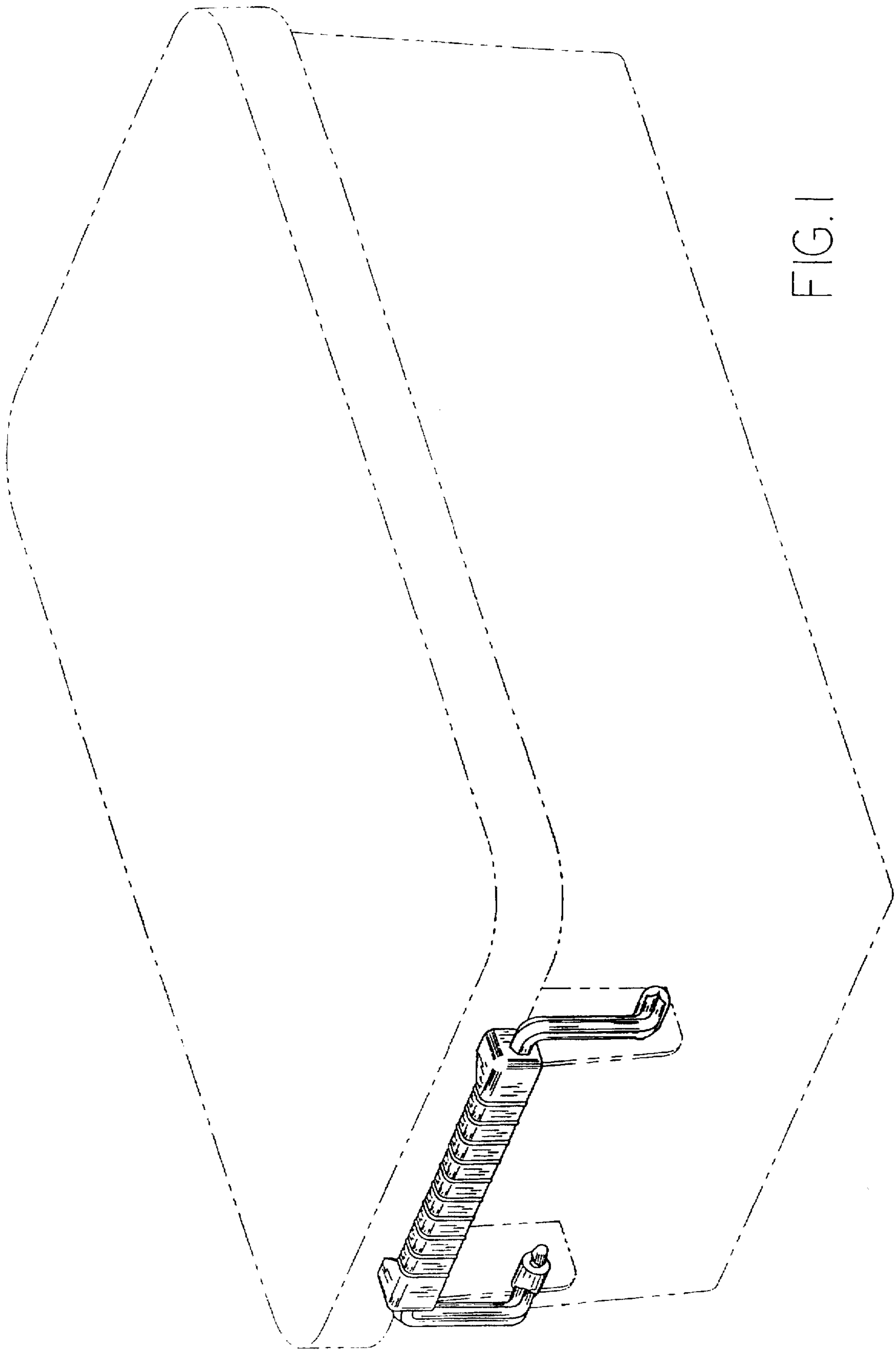

FIG. 1

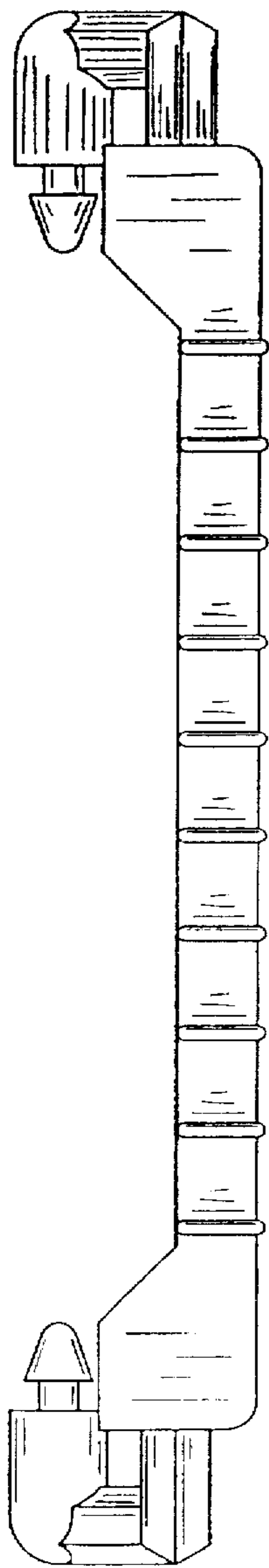

FIG. 4

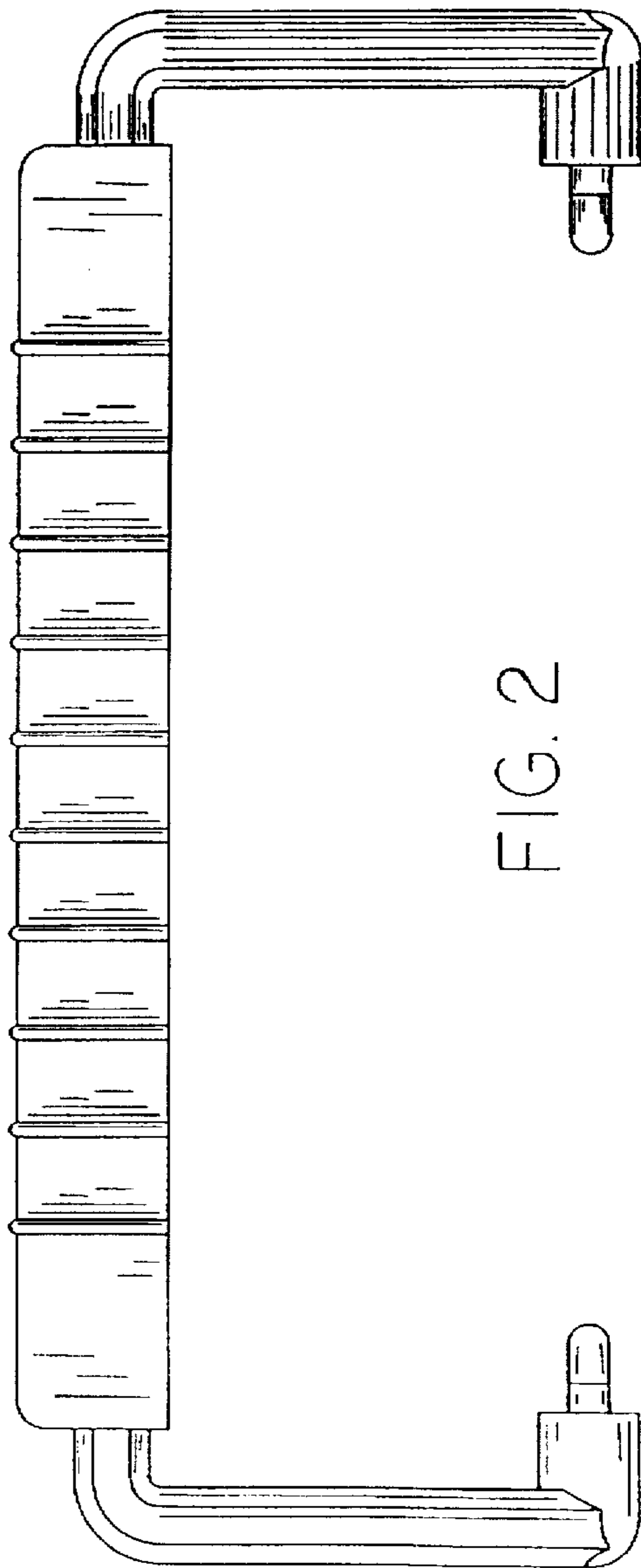

FIG. 2

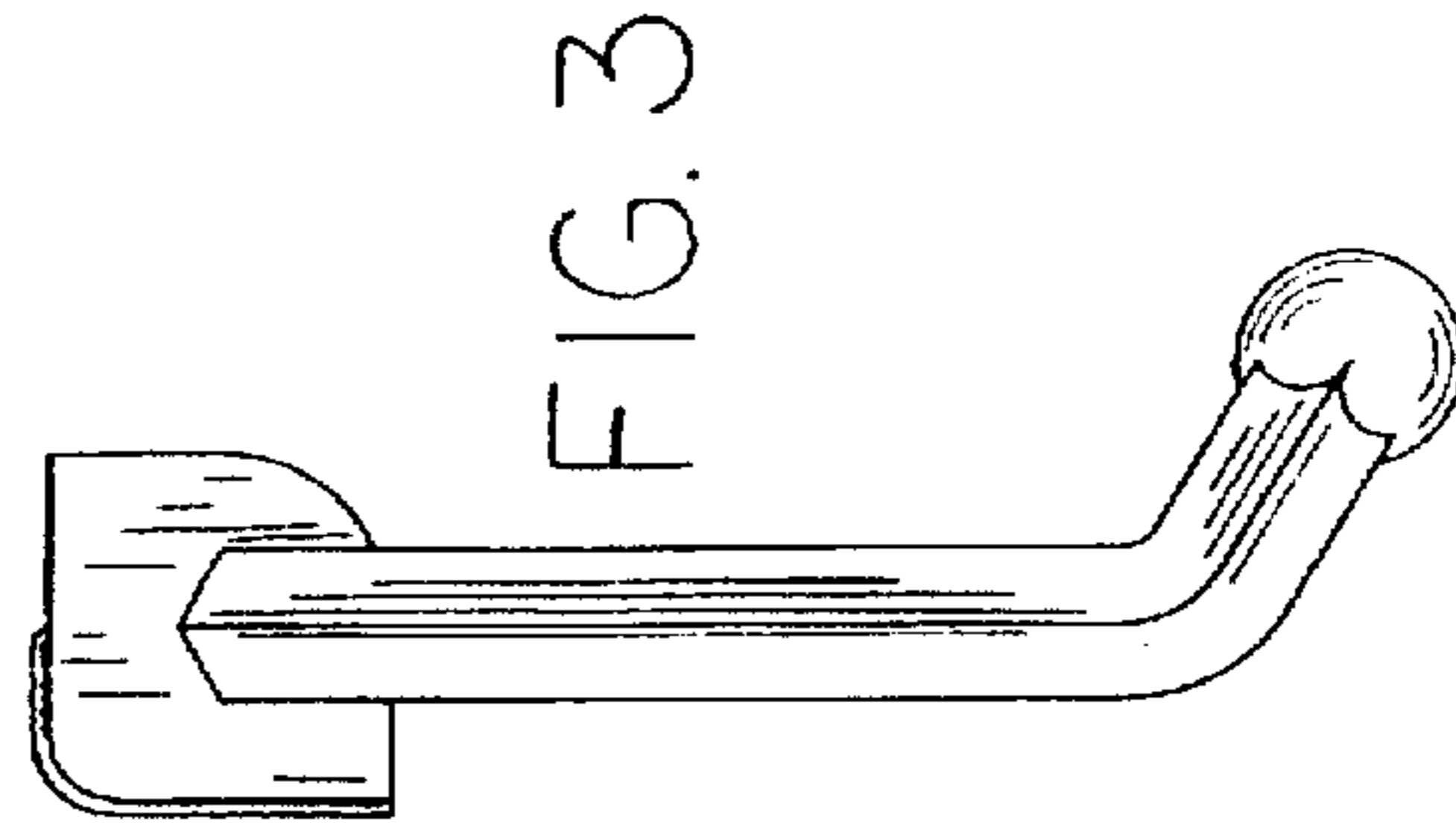

FIG. 3

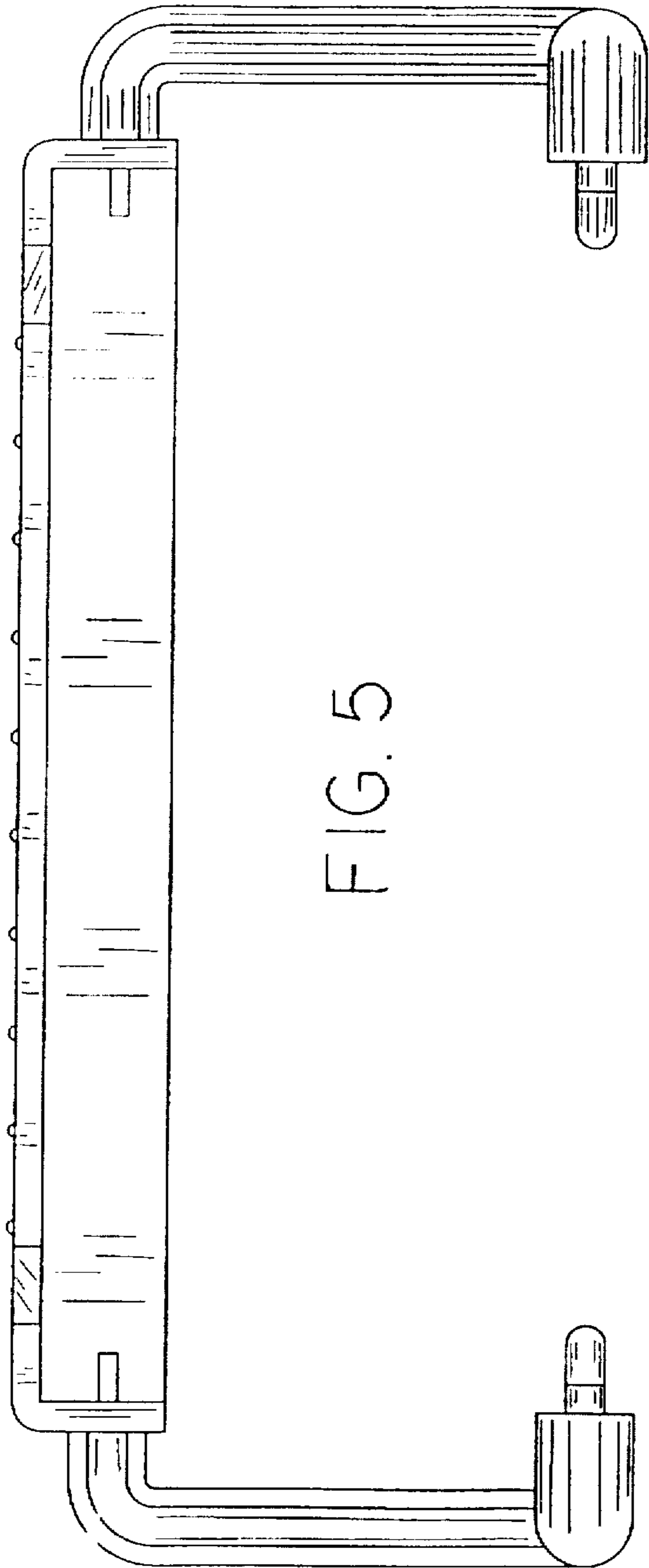

FIG. 5

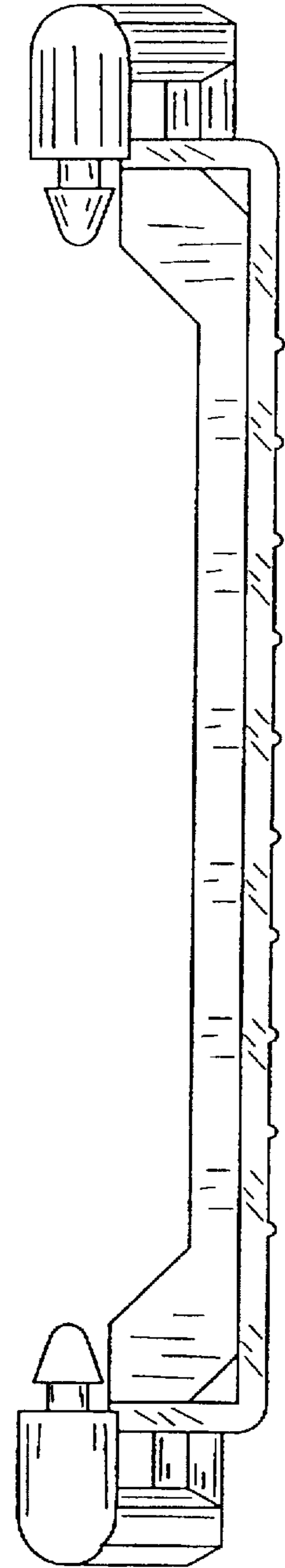

FIG. 6