



US00D394096S

United States Patent [19]
Edgar

[11] **Patent Number: Des. 394,096**

[45] **Date of Patent: **May 5, 1998**

[54] **MOUNT FOR SECURING A SIGHTING LIGHT TO A FIREARM**

5,042,186 8/1991 Bechtel 42/103
5,107,612 4/1992 Bechtel 42/103

[76] **Inventor: Mark S. Edgar, P.O. Box 261, Clarkston, Wash. 99403**

[**] **Term: 14 Years**

[21] **Appl. No.: 60,744**

[22] **Filed: Oct. 4, 1996**

[51] **LOC (6) Cl. 22-01**

[52] **U.S. Cl. D22/110; D22/108; D22/109**

[58] **Field of Search D22/100, 108, D22/109, 110; 33/241, 245, 247, 252; 42/101, 103**

[56] **References Cited**

U.S. PATENT DOCUMENTS

D. 270,748	9/1983	Bechtel	D22/110
D. 281,804	12/1985	Bechtel	D22/110
D. 331,442	12/1992	Bechtel	D22/110
D. 331,443	12/1992	Bechtel	D22/110
D. 365,621	12/1995	Coste	D22/109
894,306	7/1908	Wright	.	
1,215,171	2/1917	Lewis	.	
1,535,459	4/1925	Fredrickson	.	
2,043,430	6/1936	Doe	33/247
2,546,242	3/1951	Stinson	240/6.41
3,381,924	5/1968	Gagnier	33/247
4,562,658	1/1986	Govett	33/247 X
4,742,635	5/1988	Ruger et al.	33/245 X
4,890,407	1/1990	Nichols	42/100
4,894,941	1/1990	Karow, Jr.	42/103

Primary Examiner—Louis S. Zarfes
Assistant Examiner—Monica A. Weingart
Attorney, Agent, or Firm—Wells, St. John, Roberts, Gregory & Matkin P.S.

[57] **CLAIM**

The ornamental design for mount for securing a sighting light to a firearm, as shown and described.

DESCRIPTION

FIG. 1 is a perspective view of a first preferred form of a mount for securing a sighting light to a firearm showing my new design;
FIG. 2 is a reduced front elevation view thereof;
FIG. 3 is a reduced left side elevation view thereof;
FIG. 4 is a reduced right side elevation view thereof;
FIG. 5 is a reduced rear elevation view thereof;
FIG. 6 is a reduced top plan view thereof;
FIG. 7 is a reduced bottom plan view thereof;
FIG. 8 is a perspective view of a second embodiment of FIG. 1;
FIG. 9 is an exploded perspective view of FIG. 8;
FIG. 10 is a reduced front elevation view of FIG. 8;
FIG. 11 is a reduced side elevation view of FIG. 8;
FIG. 12 is a reduced right side elevation view of FIG. 8;
FIG. 13 is a reduced rear elevation view of FIG. 8;
FIG. 14 is a reduced top plan view of FIG. 8; and
FIG. 15 is a reduced bottom plan view of FIG. 8.

1 Claim, 4 Drawing Sheets

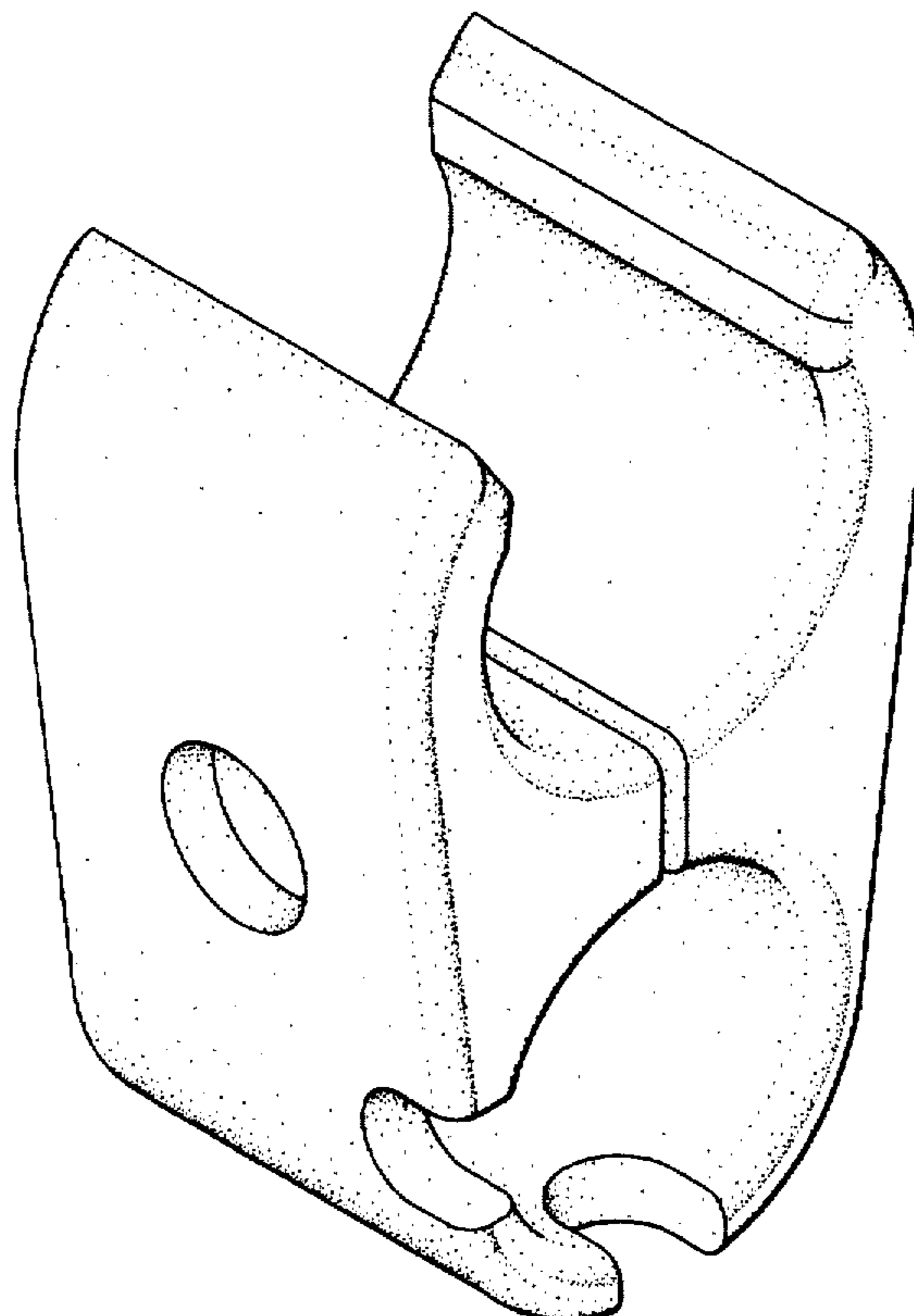

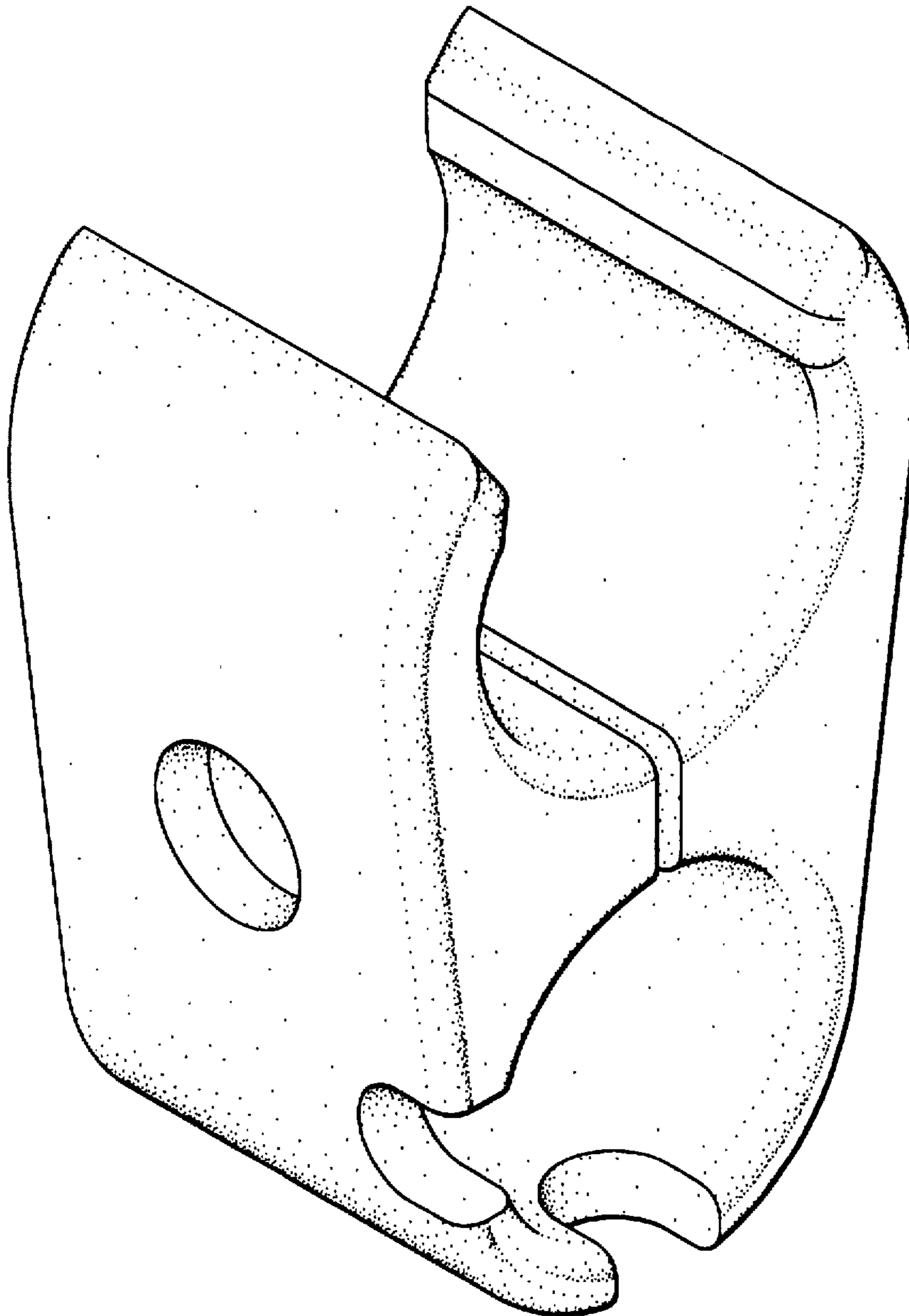

Fig. 1 II

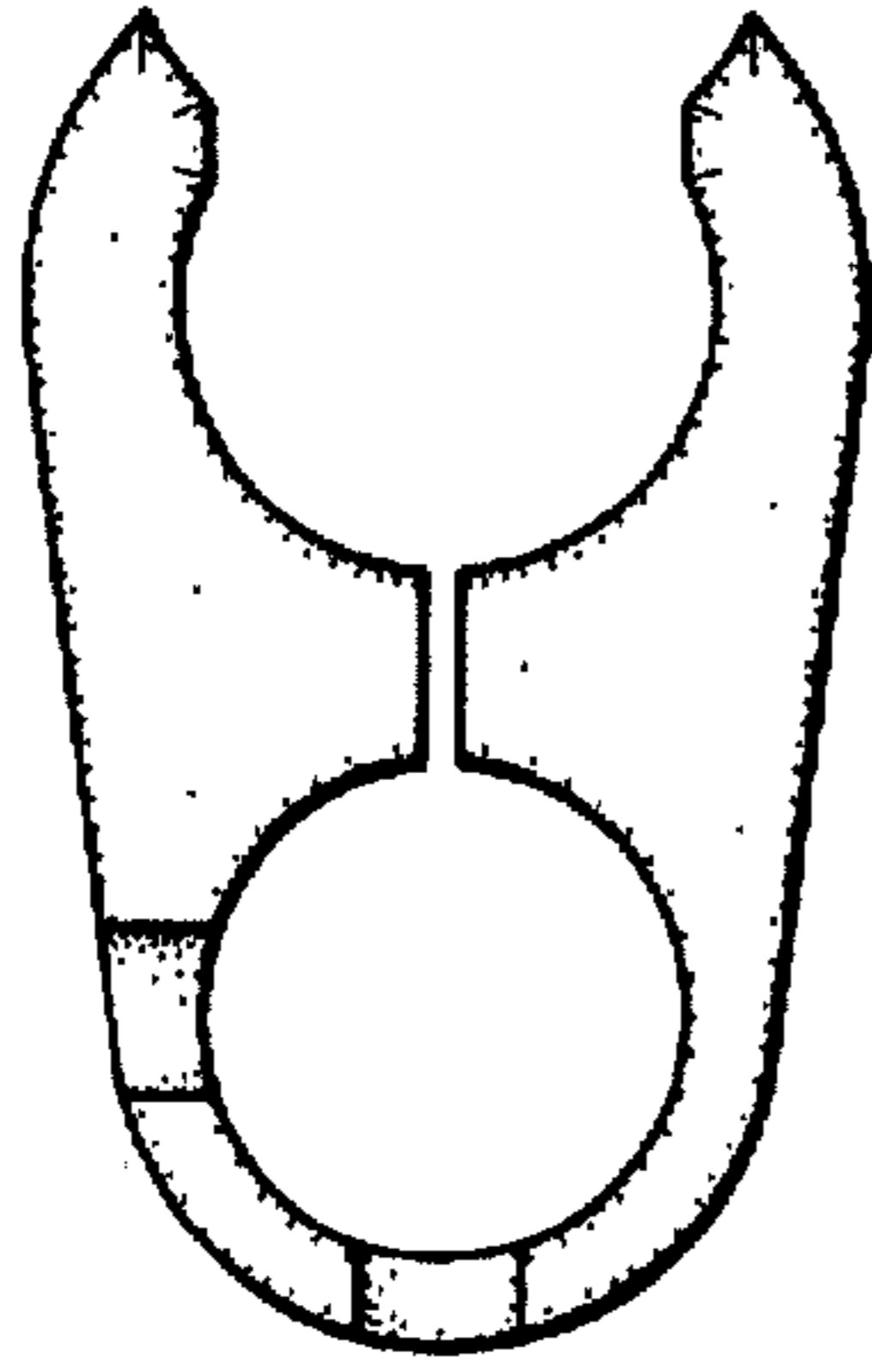

Fig. 2

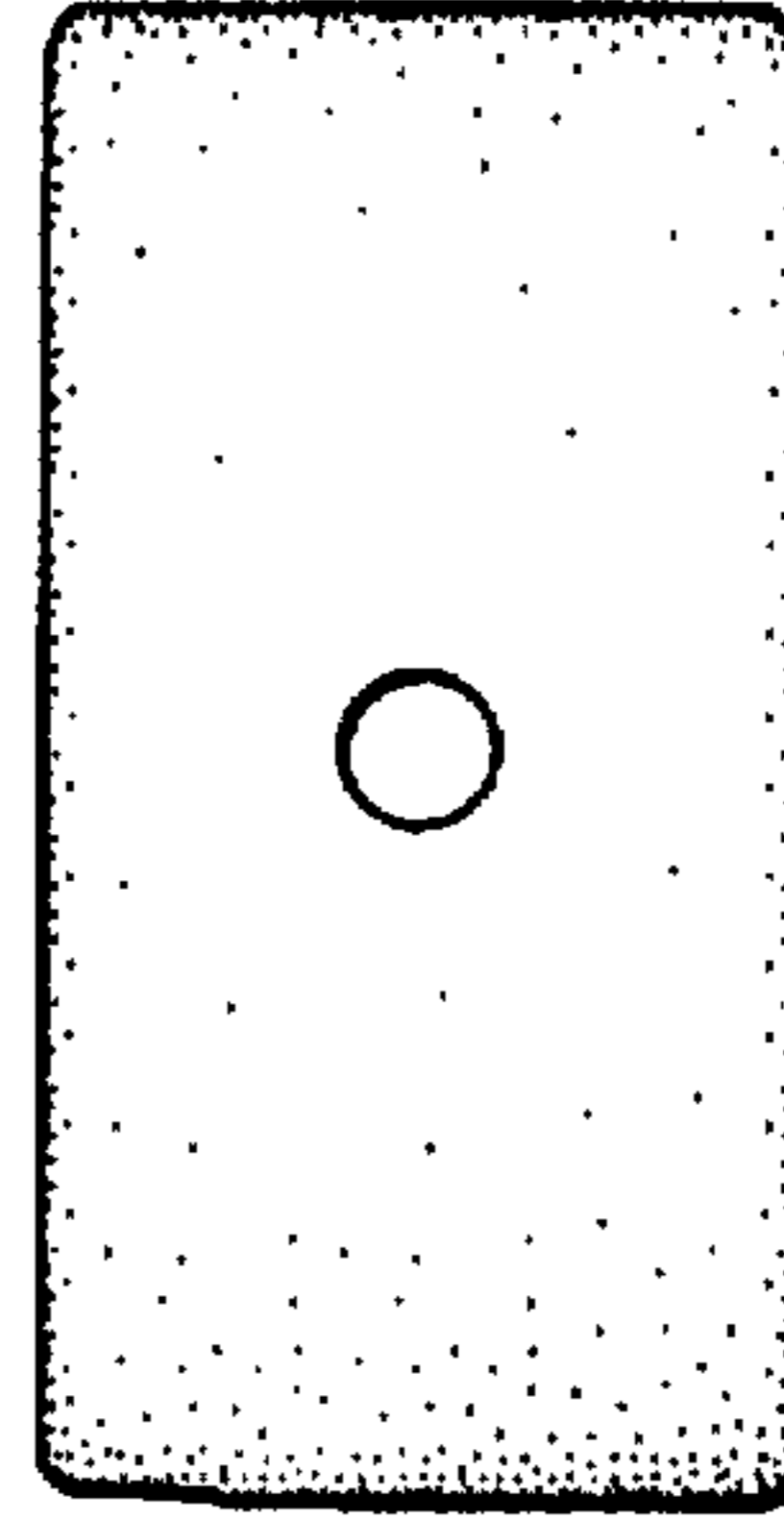

Fig. 3

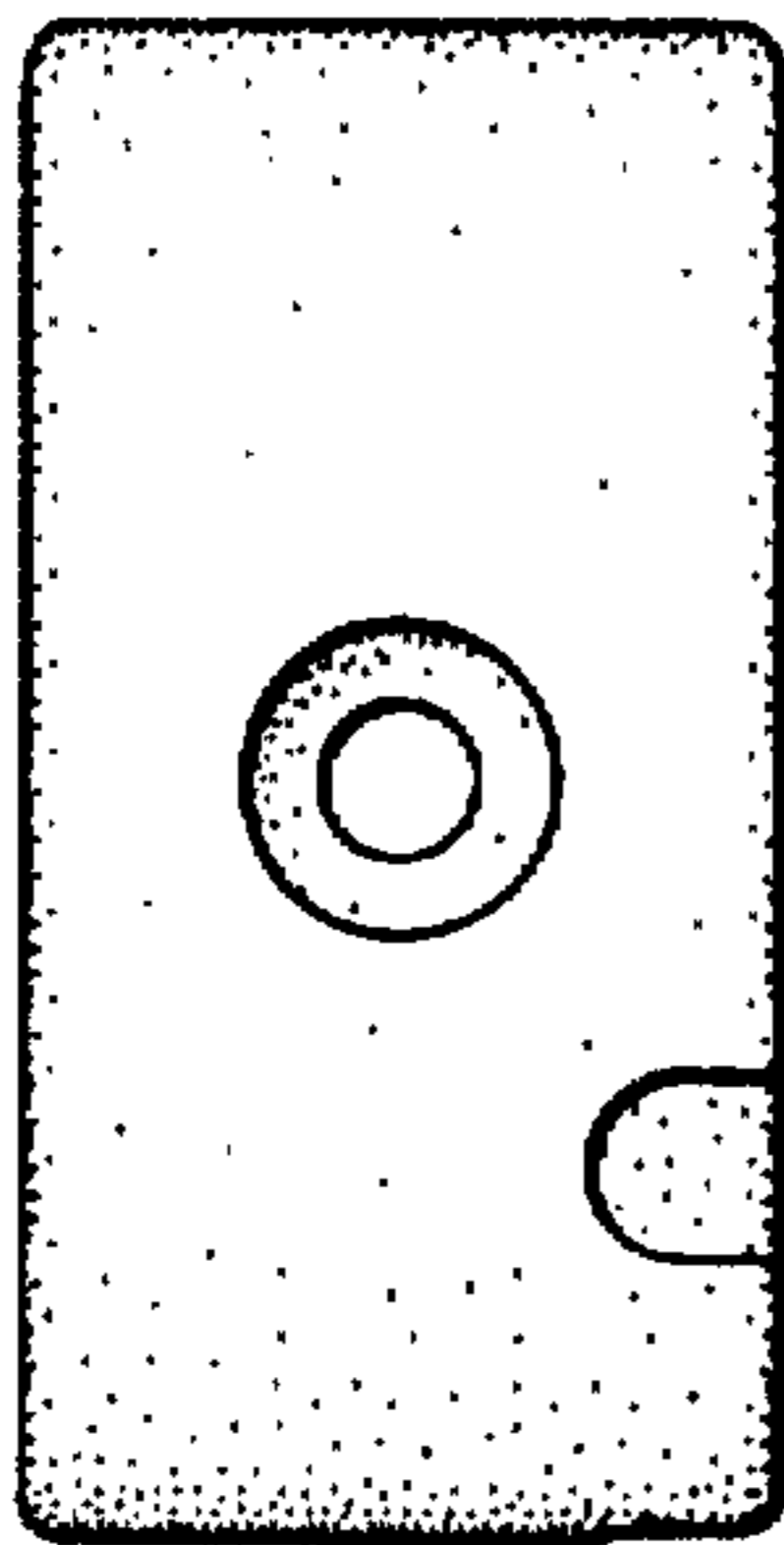

Fig. 4

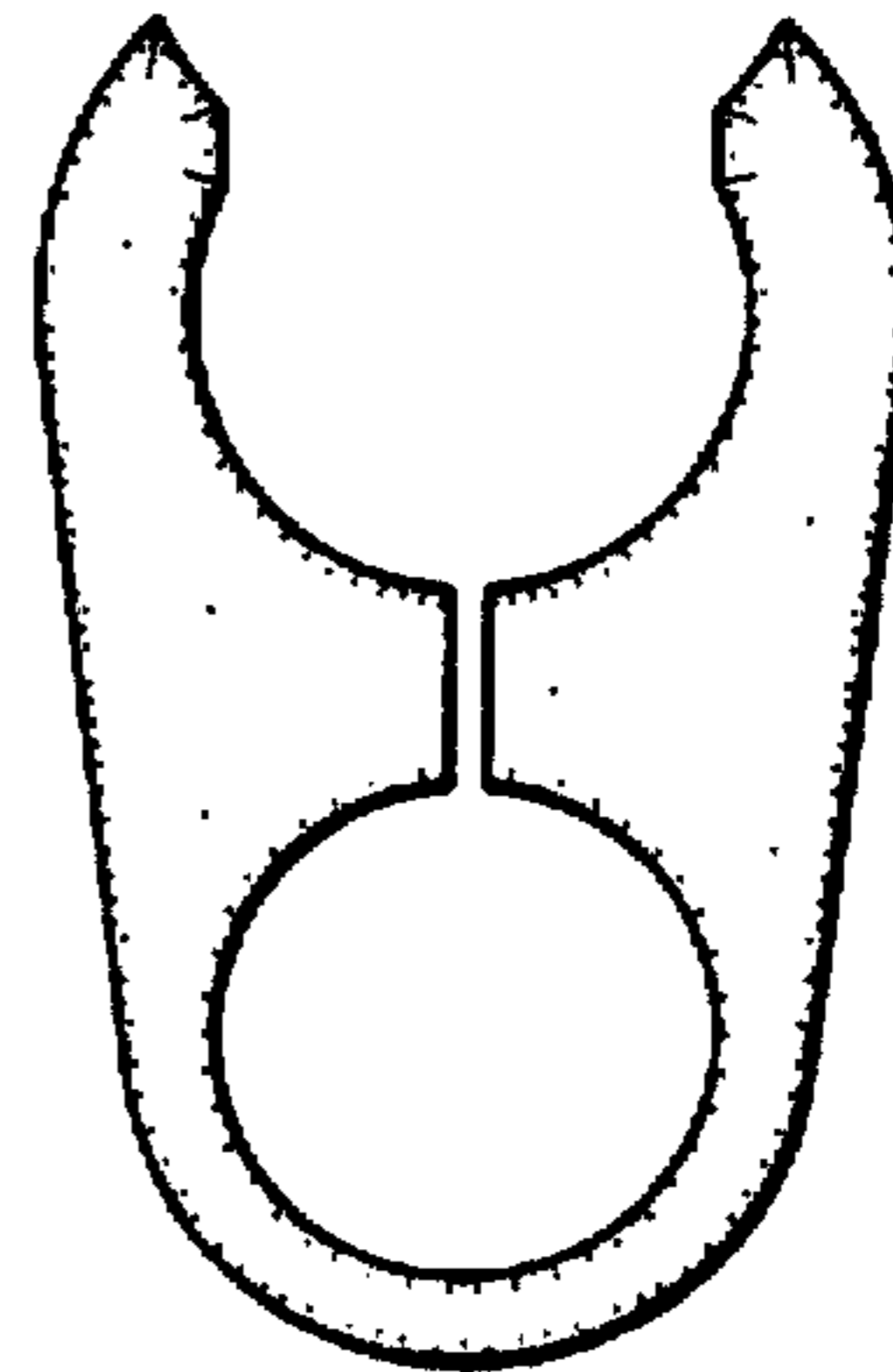

Fig. 5

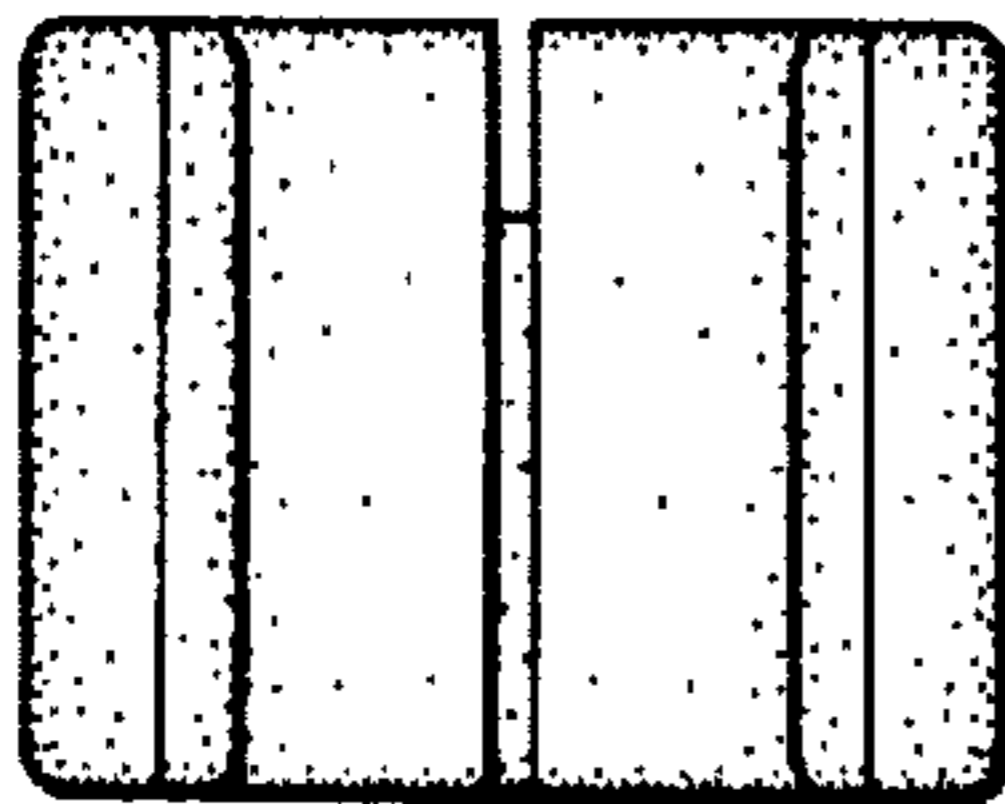

Fig. 6

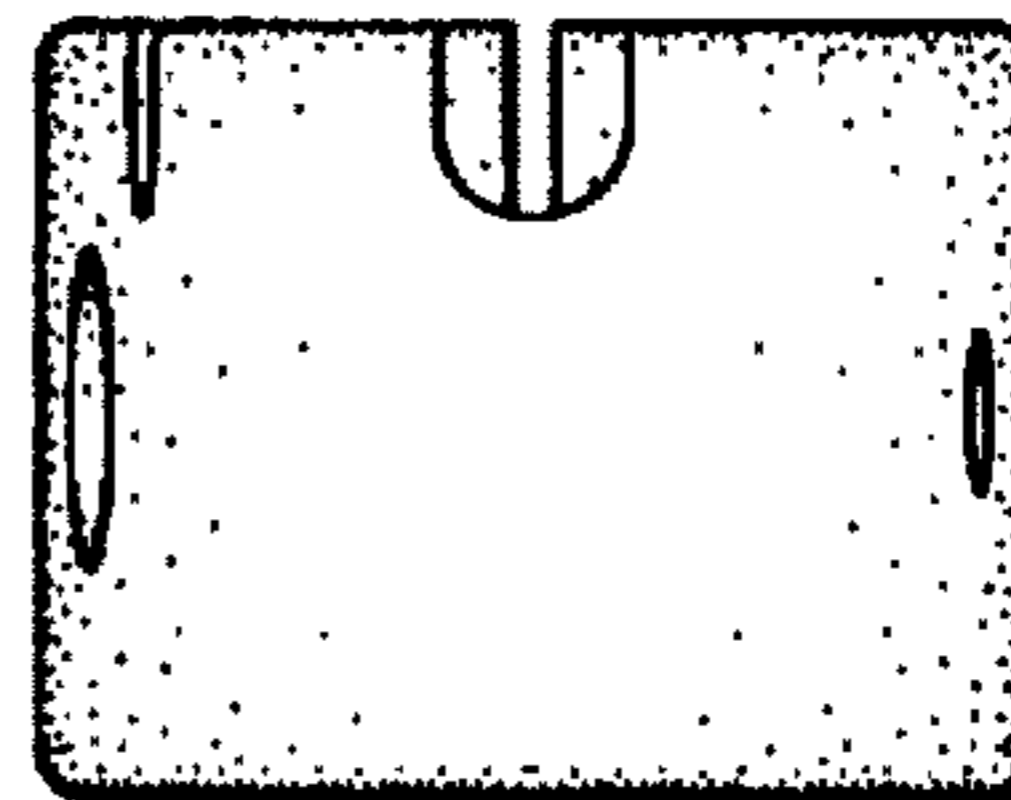

Fig. 7

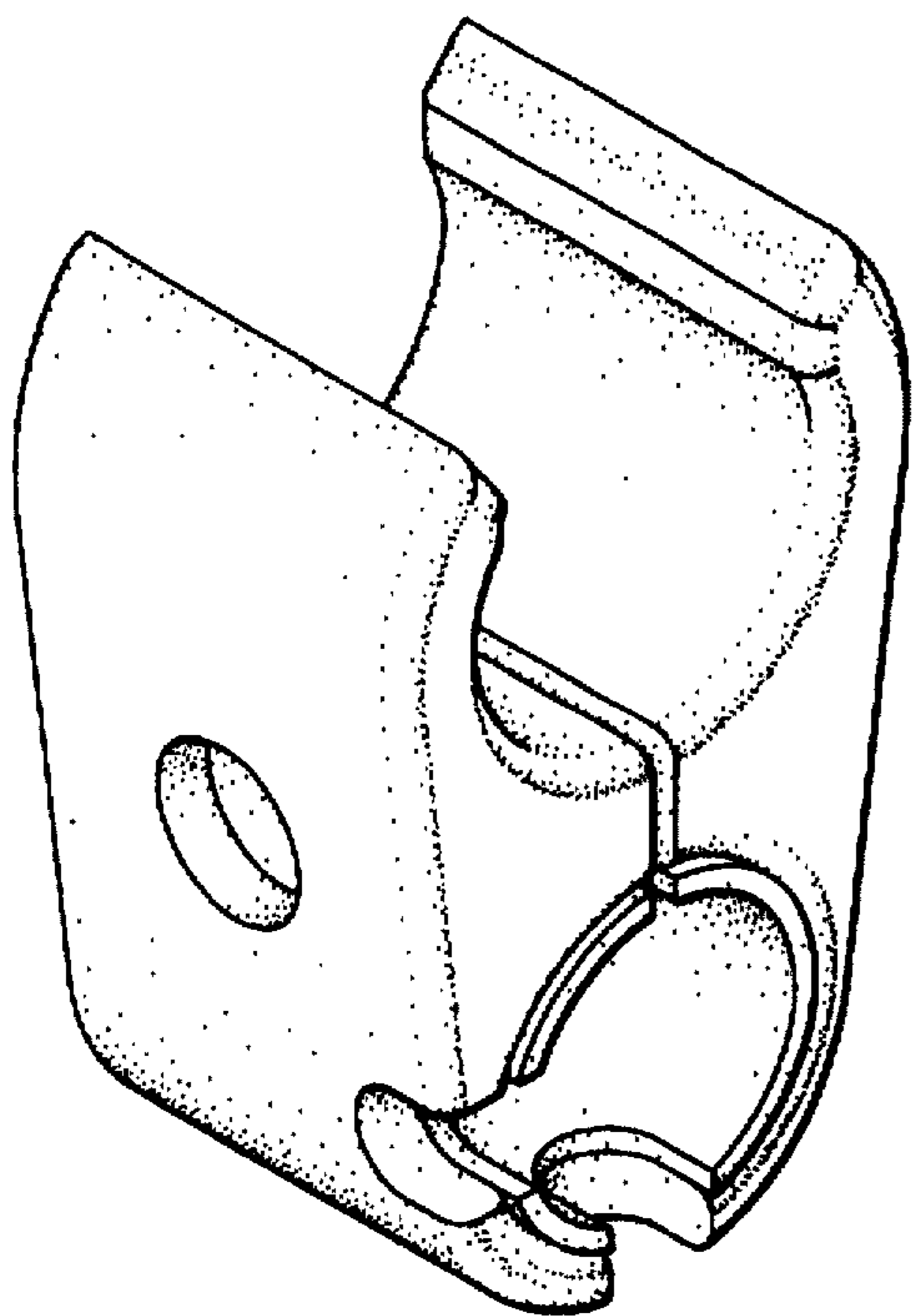

FIG. 8

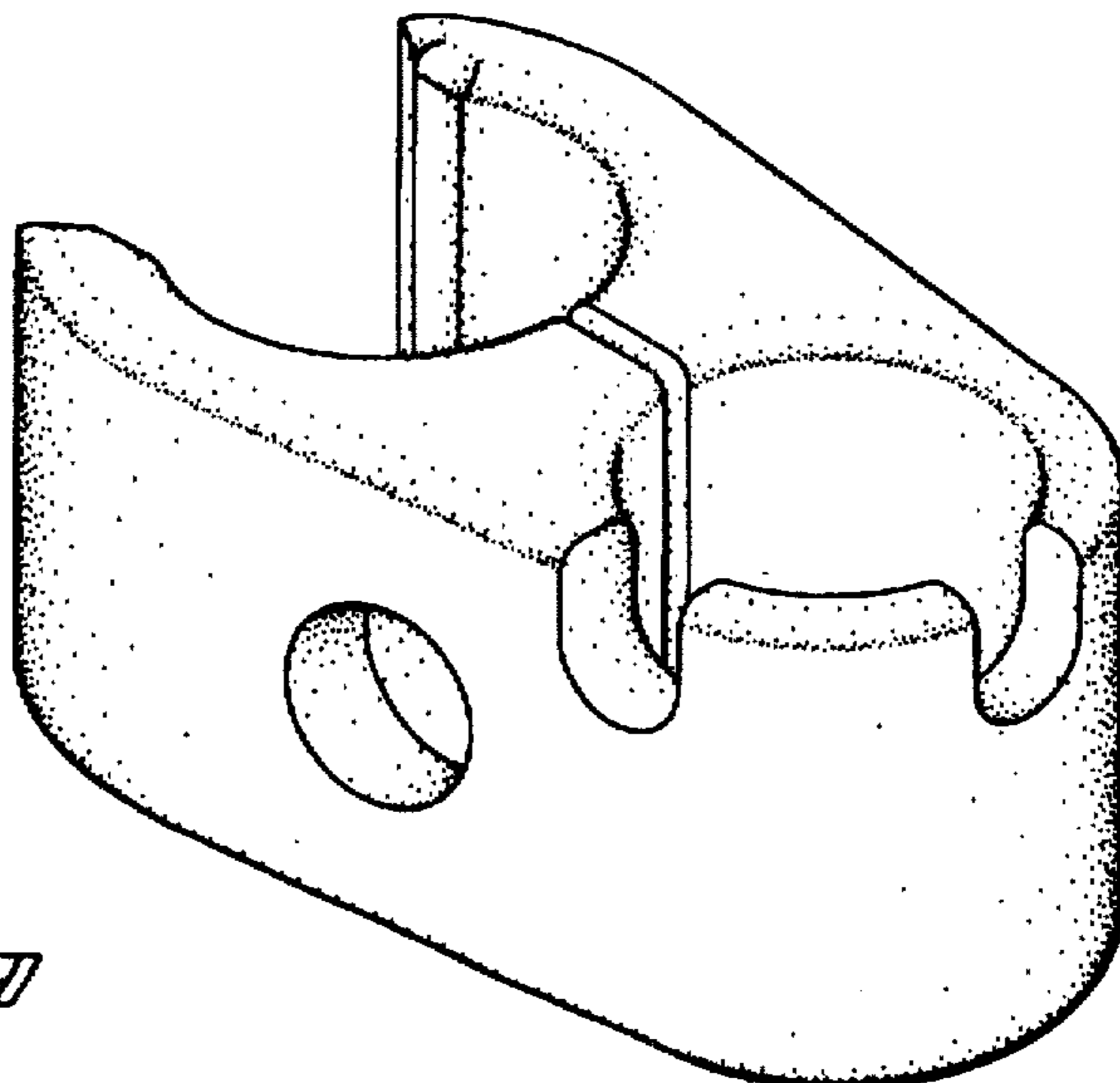
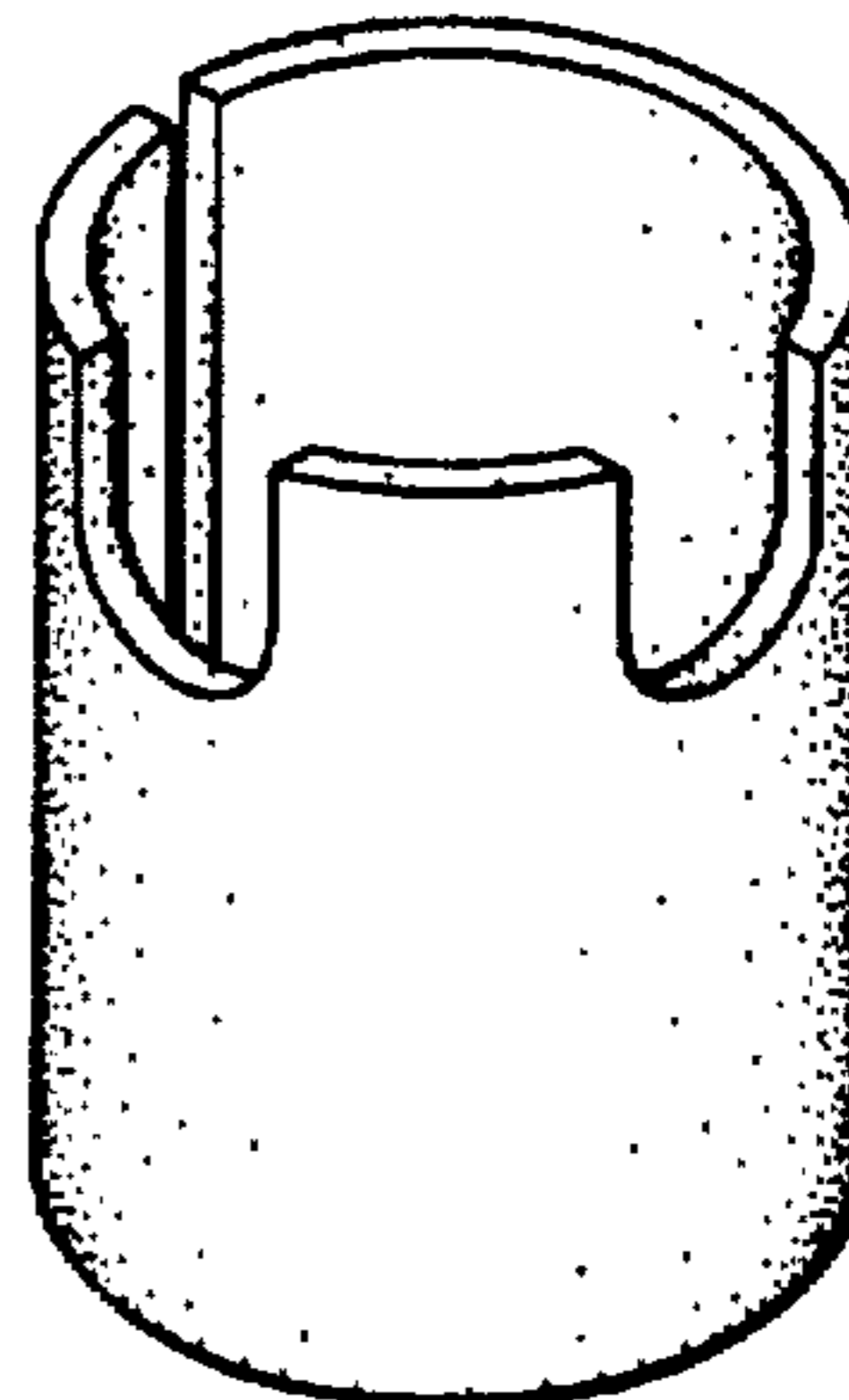

FIG. 9

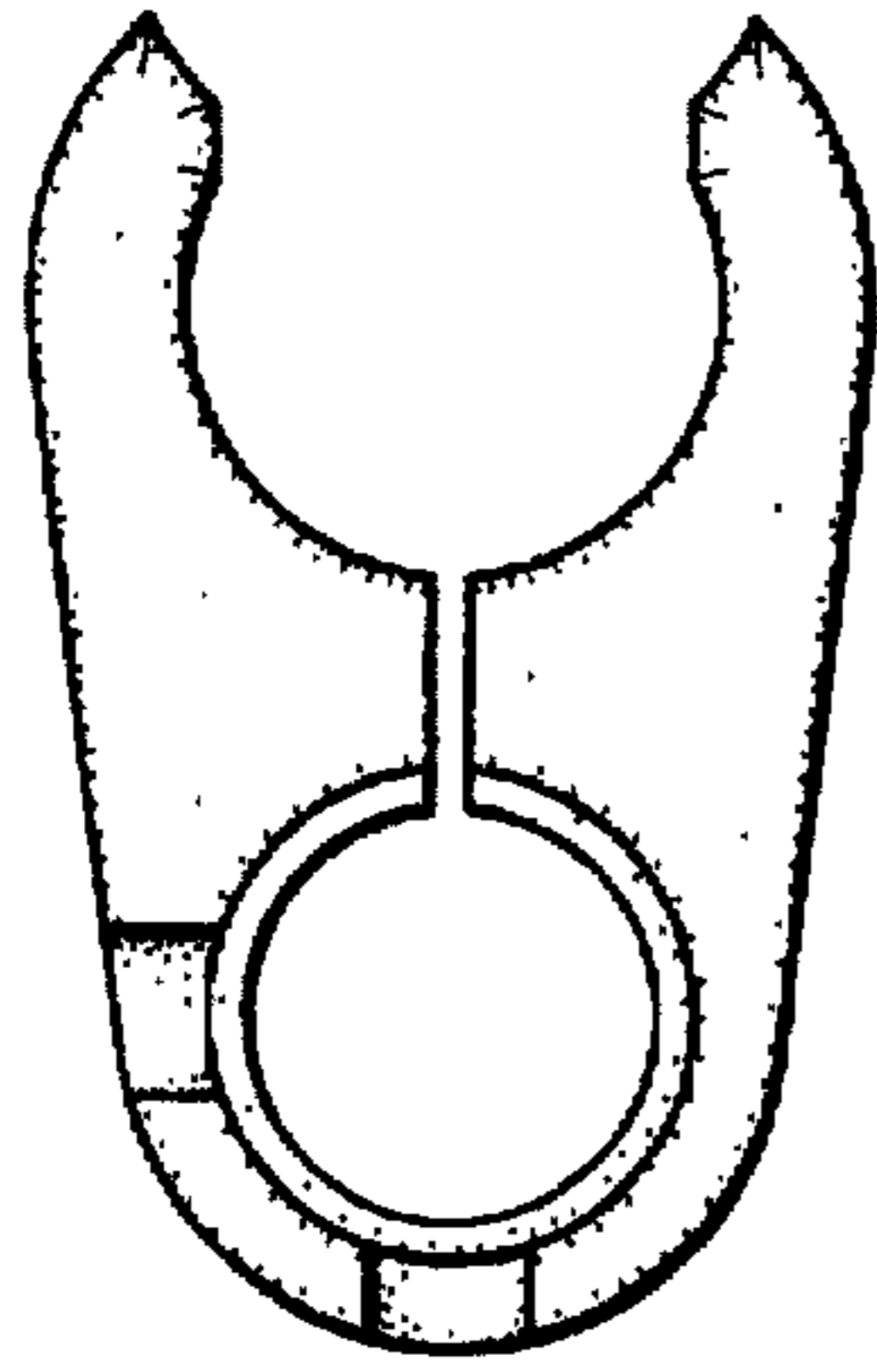

Fig. 10

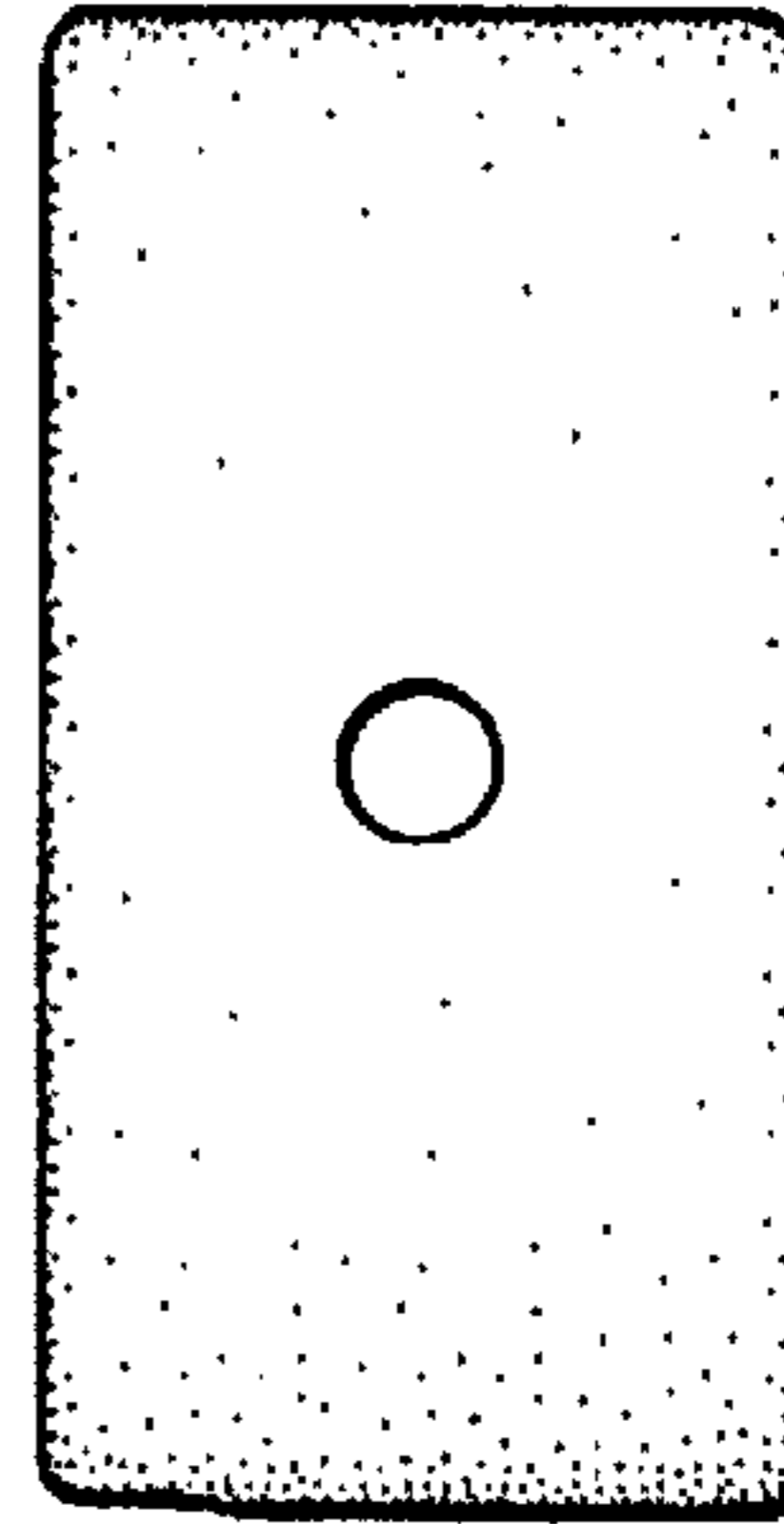

Fig. 11

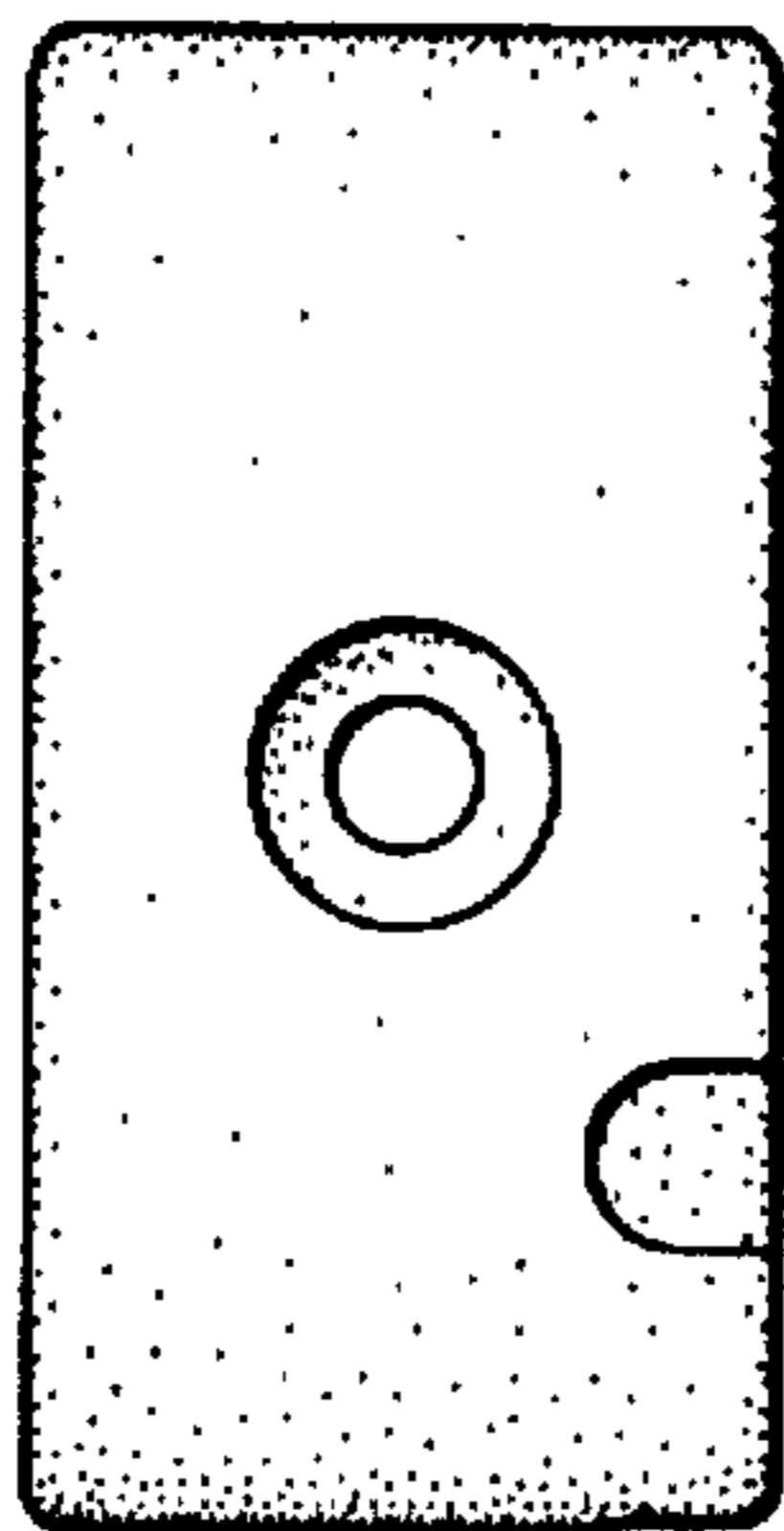

Fig. 12

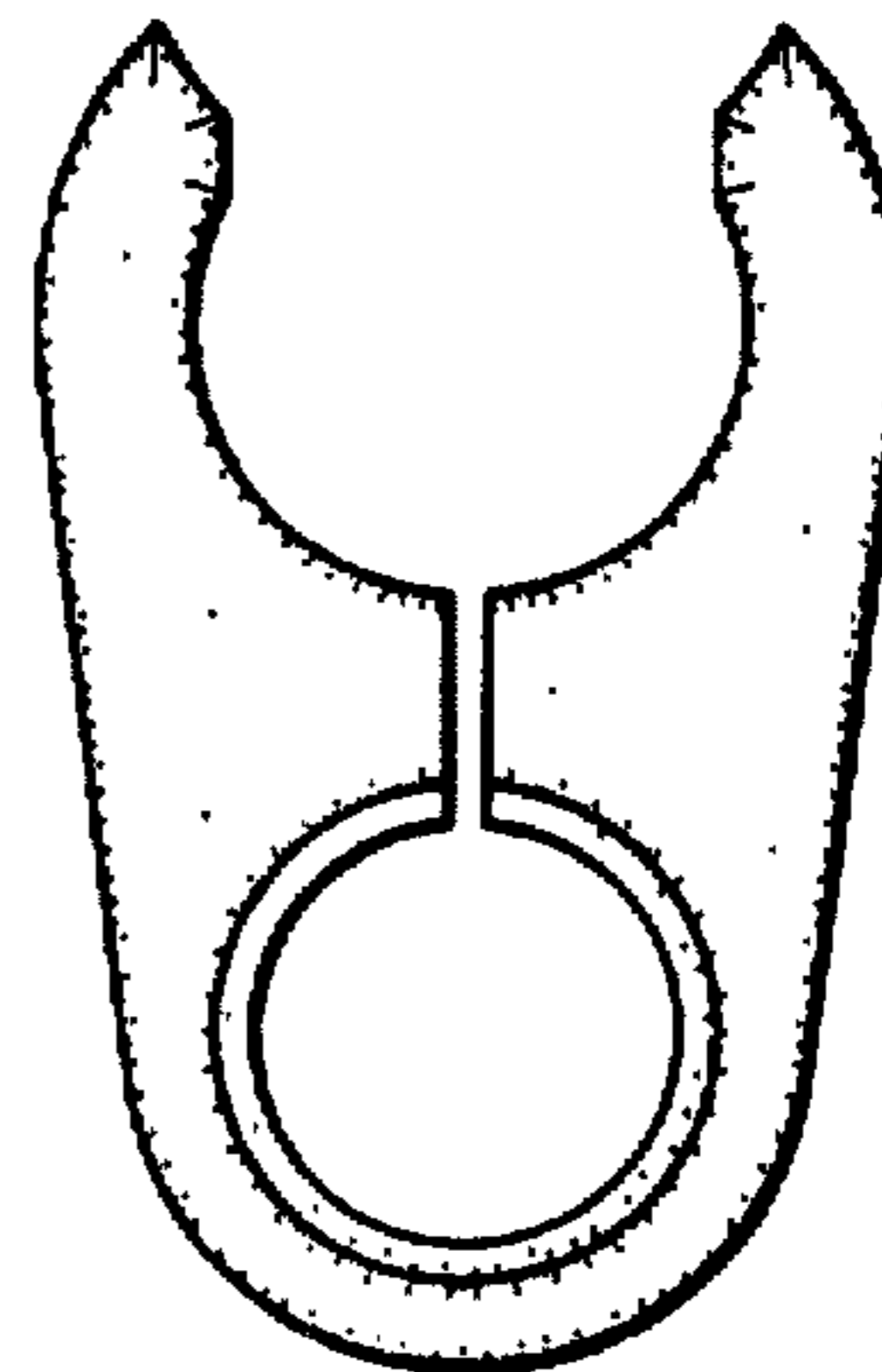

Fig. 13

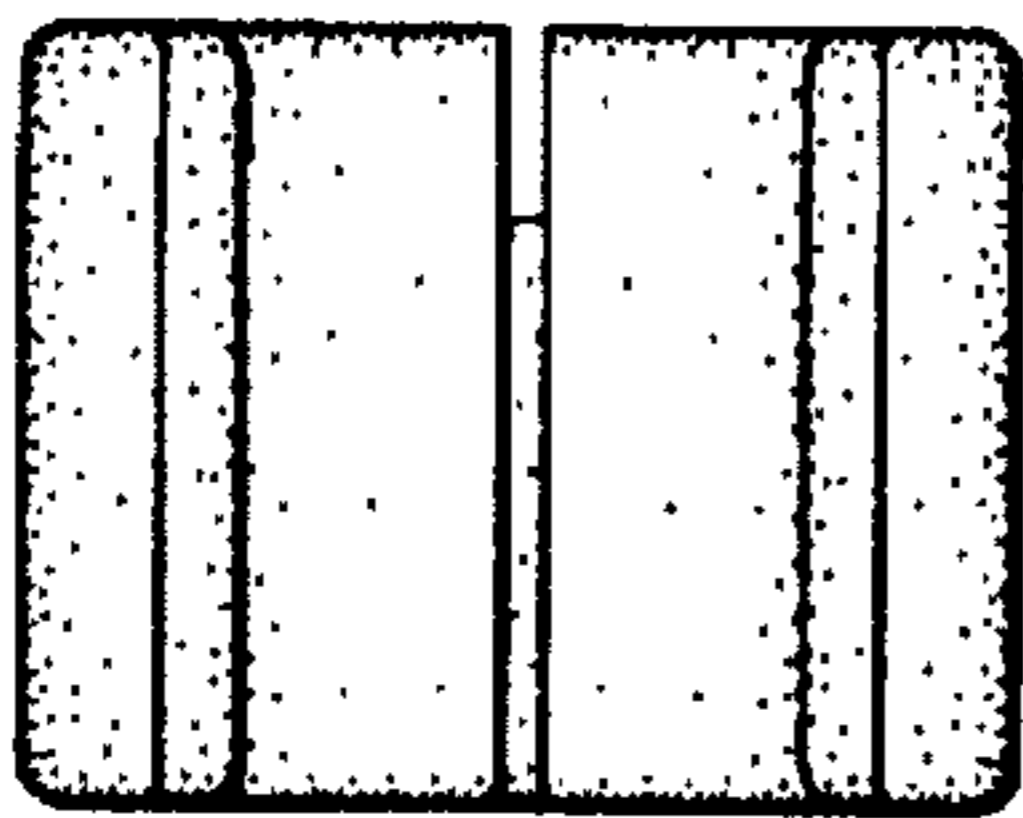

Fig. 14

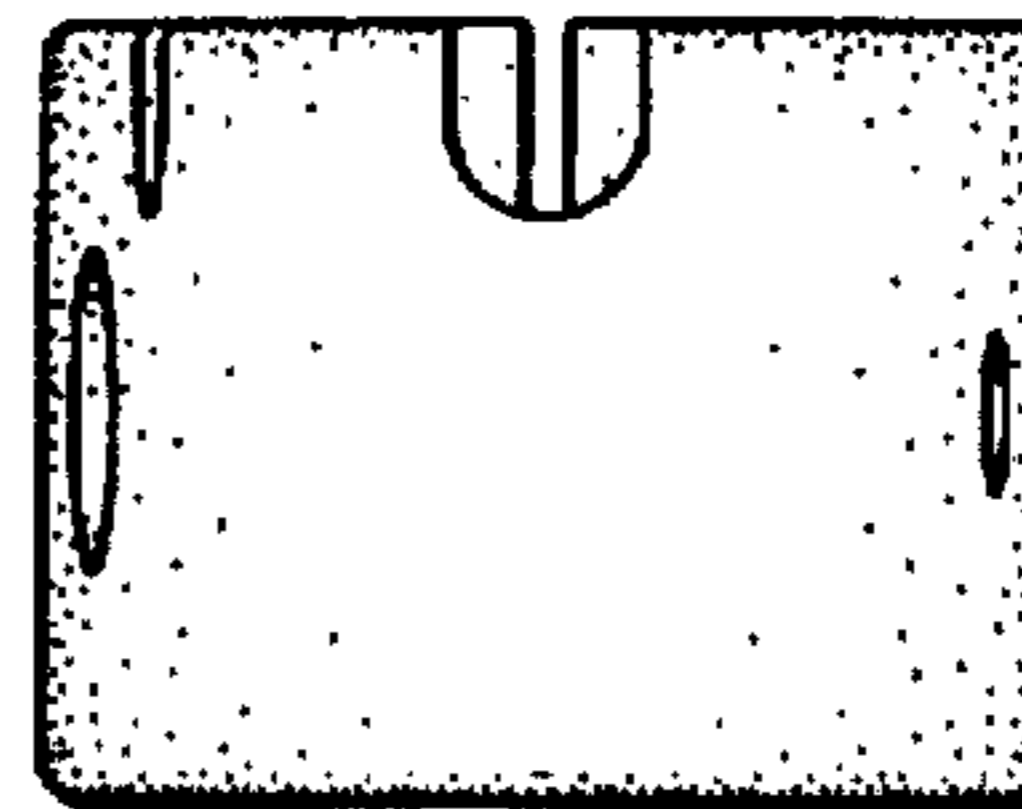

Fig. 15