

US00D394055S

United States Patent [19] Tyler

[11] Patent Number: **Des. 394,055**

[45] Date of Patent: ****May 5, 1998**

[54] **MEMORY PACK FOR VIDEO GAMES**

D. 377,488 1/1997 Ashida D14/121
5,362,068 11/1994 Liu 273/148 B X

[76] Inventor: **Kelly D. Tyler**, Box 841, Jamul, Calif.
91935

Primary Examiner—Kay H. Chin

[**] Term: **14 Years**

[57] **CLAIM**

[21] Appl. No.: **63,229**

The ornamental design for a memory pack for video games,
as shown and described.

[22] Filed: **Dec. 2, 1996**

DESCRIPTION

[51] LOC (6) Cl. **14-99**

FIG. 1 is a rear perspective view of the novel memory pack
for video games;

[52] U.S. Cl. **D14/121; D14/114**

FIG. 2 is an upside down front perspective view thereof;

[58] **Field of Search** D14/120-123,
D14/114, 199, 100; 242/348-348.4, 341,
335; D21/13, 48; 273/148 R; 463/29, 44

FIG. 3 is a top plan view thereof;

FIG. 4 is a right side elevation view and the left side
elevation is exactly the same but reversed;

[56] **References Cited**

FIG. 5 is a bottom plan view thereof;

U.S. PATENT DOCUMENTS

FIG. 6 is a front elevation view thereof; and,

FIG. 7 is a rear elevation view thereof.

D. 320,203 9/1991 Ashida D14/121

D. 330,370 10/1992 Tseng D14/121

1 Claim, 1 Drawing Sheet

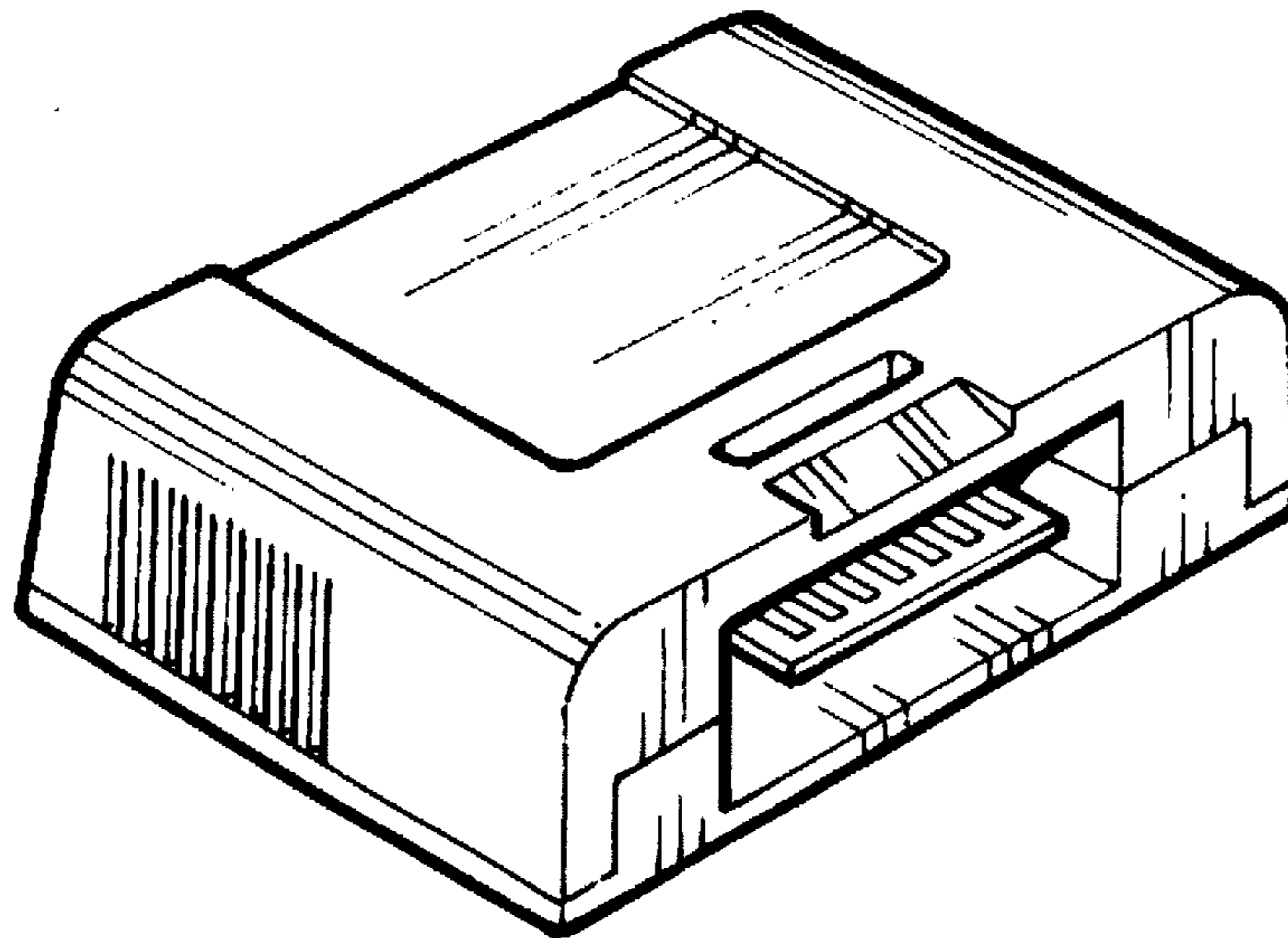

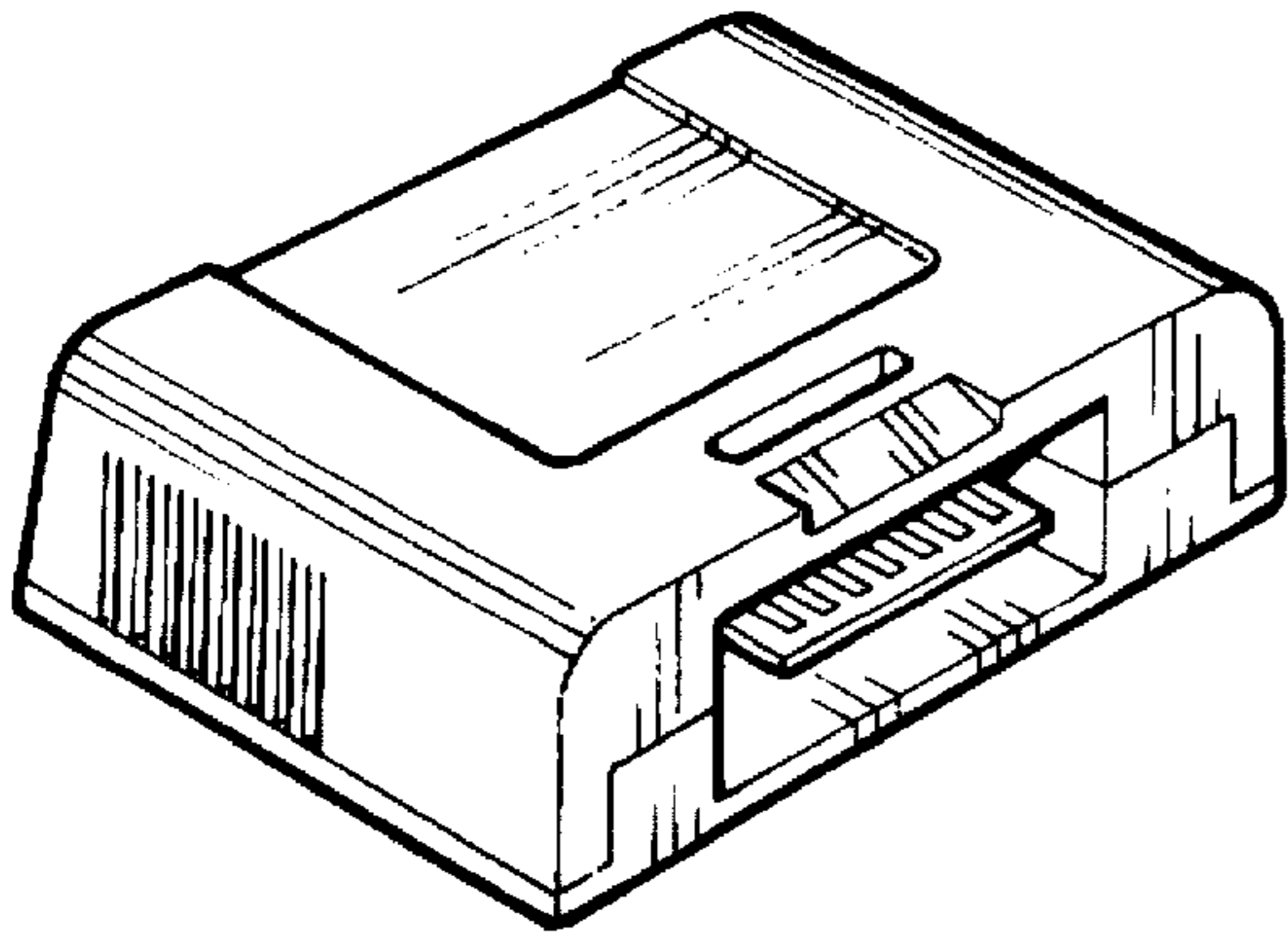

FIGURE 1

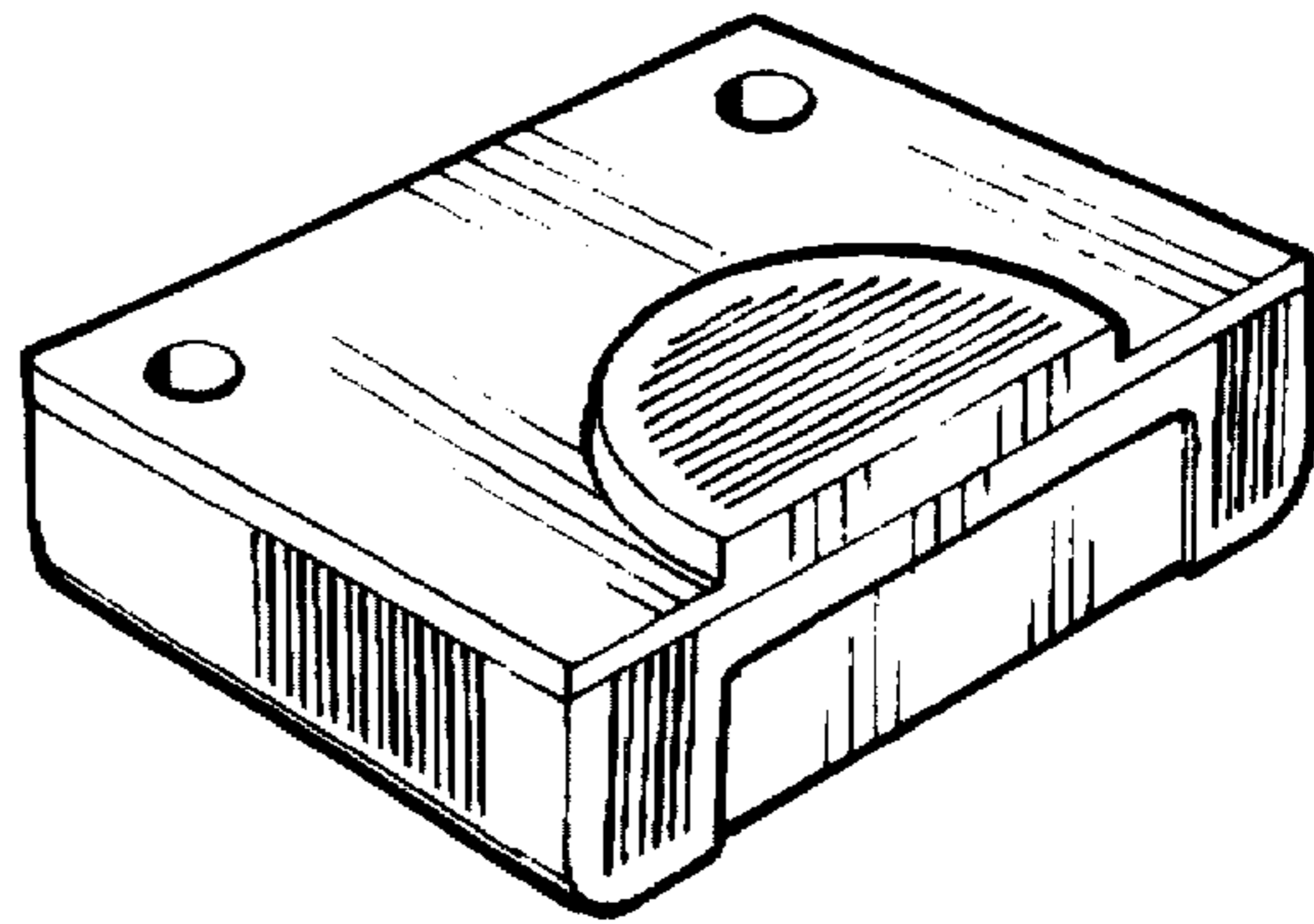

FIGURE 2

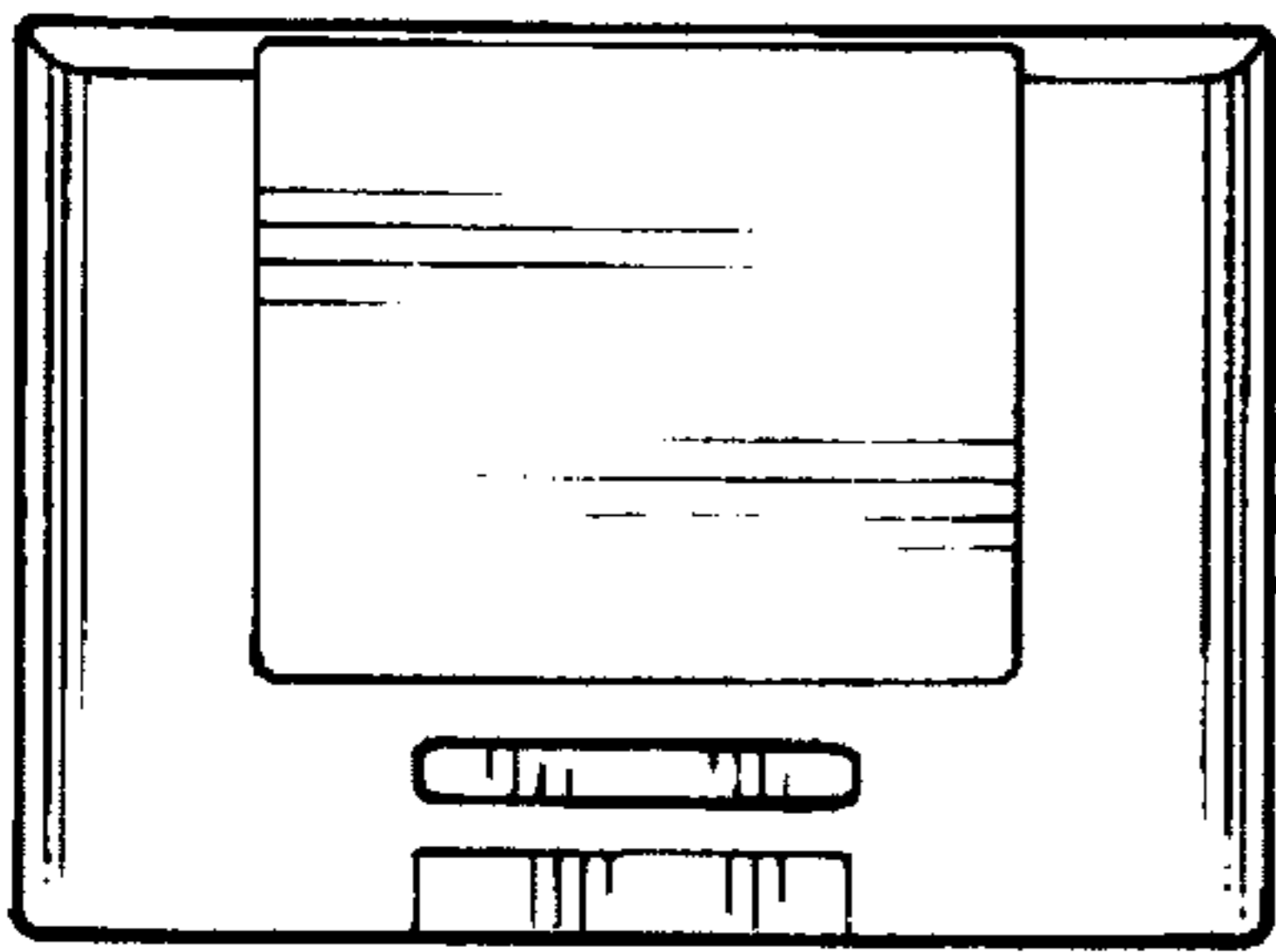

FIGURE 3

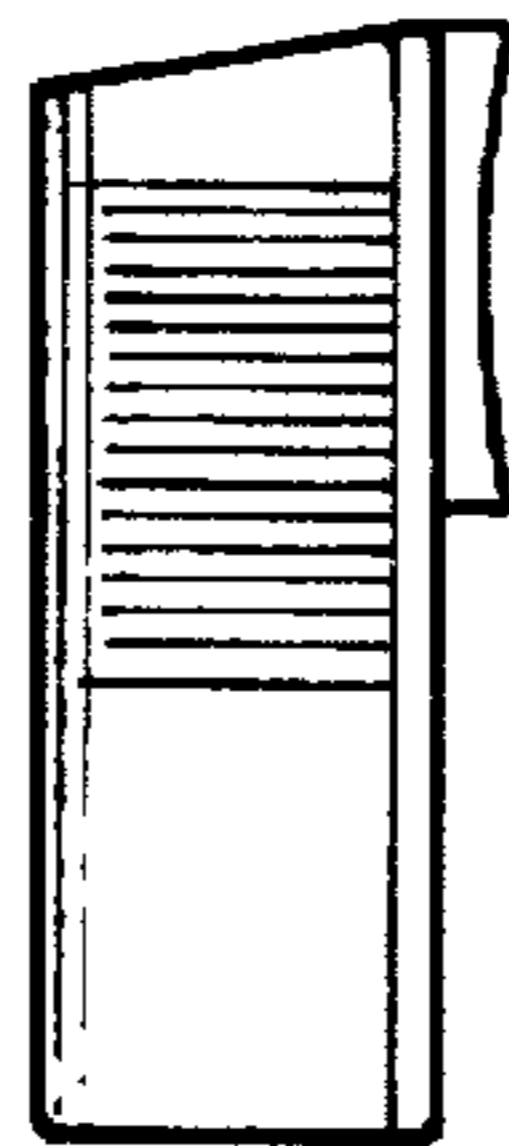

FIGURE 4

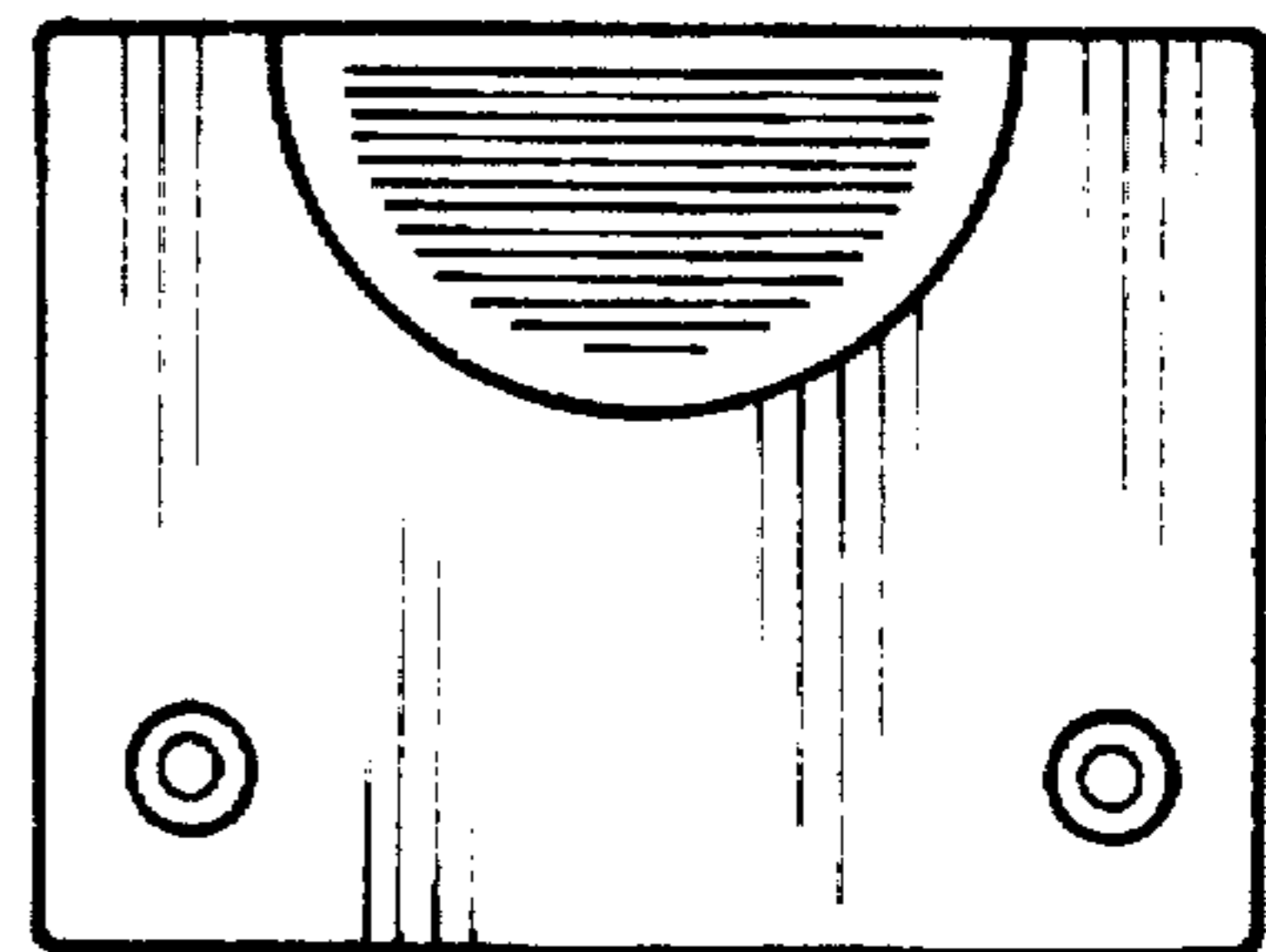

FIGURE 5

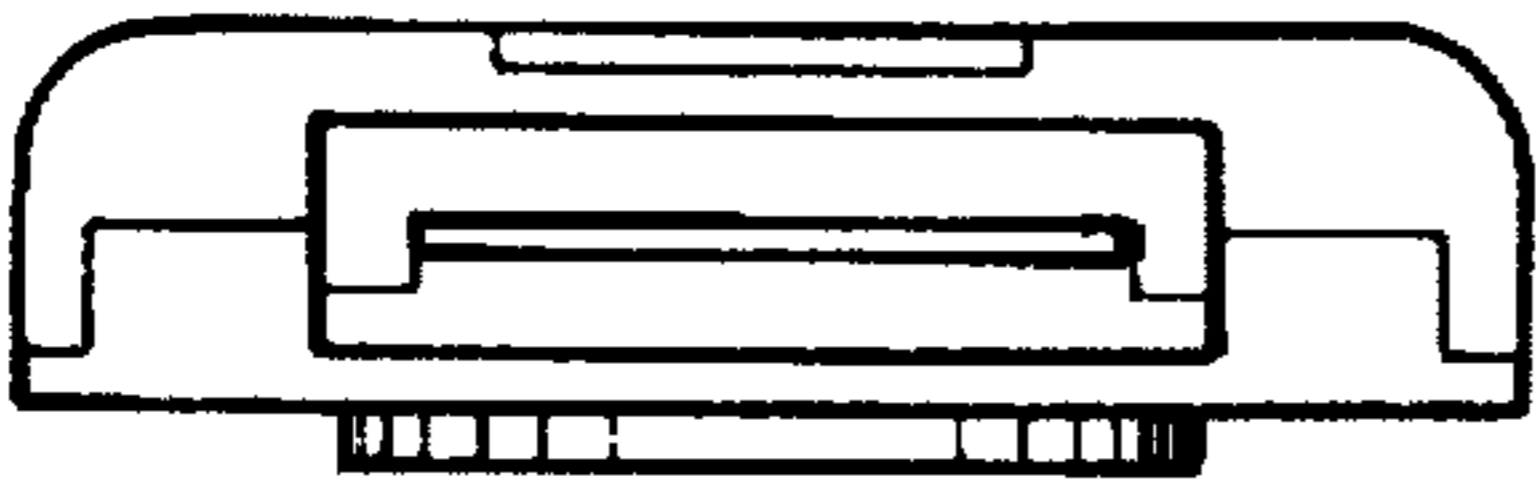

FIGURE 6



FIGURE 7