

US00D393988S

United States Patent [19] Rogers

[11] Patent Number: **Des. 393,988**

[45] Date of Patent: ****May 5, 1998**

[54] **PLATE HOLDER**

[76] Inventor: **Ian Derrick Rogers**, 13 Grosskopf Street, Helderkruin, Roodepoort, South Africa

[**] Term: **14 Years**

[21] Appl. No.: **64,087**

[22] Filed: **Dec. 12, 1996**

[30] **Foreign Application Priority Data**

Jun. 14, 1996 [ZA] South Africa F96/0533
Jun. 14, 1996 [ZA] South Africa F96/0534

[51] LOC (6) Cl. **07-06**

[52] U.S. Cl. **D7/701; D7/619**

[58] Field of Search D7/620, 619, 701,
D7/601, 688; 211/41.1, 41.2, 71; 220/23.86;
248/311.2, 313

[56] **References Cited**

U.S. PATENT DOCUMENTS

D. 115,515 7/1939 Greenberg D7/688
2,719,414 10/1955 Davis D7/620 X
2,916,180 12/1959 Alger 220/737

OTHER PUBLICATIONS

Trade Publication for "Pro-Serv Plate Holder", printed Dec. 18, 1995 and Distributed on Jan. 20, 1996.
"Pro-Serv Plate Holder" brochure, Feb. 1996.

Primary Examiner—Terry A. Wallace

Attorney, Agent, or Firm—Panitch Schwarze Jacobs & Nadel, P.C.

[57] **CLAIM**

The ornamental design for a plate holder, as shown and described.

DESCRIPTION

FIG. 1 is a perspective view of a plate holder showing my new design;

FIG. 2 is a plan view of the plate holder of FIG. 1;

FIG. 3 is an underplan view of the plate holder of FIG. 1;

FIG. 4 is a left side view of the plate holder of FIG. 1;

FIG. 5 is a right side view of the plate holder of FIG. 1;

FIG. 6 is a rear end view of the plate holder of FIG. 1;

FIG. 7 is a perspective view of a further plate holder showing my new design;

FIG. 8 is a plan view of the plate holder of FIG. 7;

FIG. 9 is an underplan view of the plate holder of FIG. 7;

FIG. 10 is a front end view of the plate holder of FIG. 7;

FIG. 11 is a rear end view of the plate holder of FIG. 7;

FIG. 12 is a left side view of the plate holder of FIG. 7; and,

FIG. 13 is a right side view of the plate holder of FIG. 7.

1 Claim, 2 Drawing Sheets

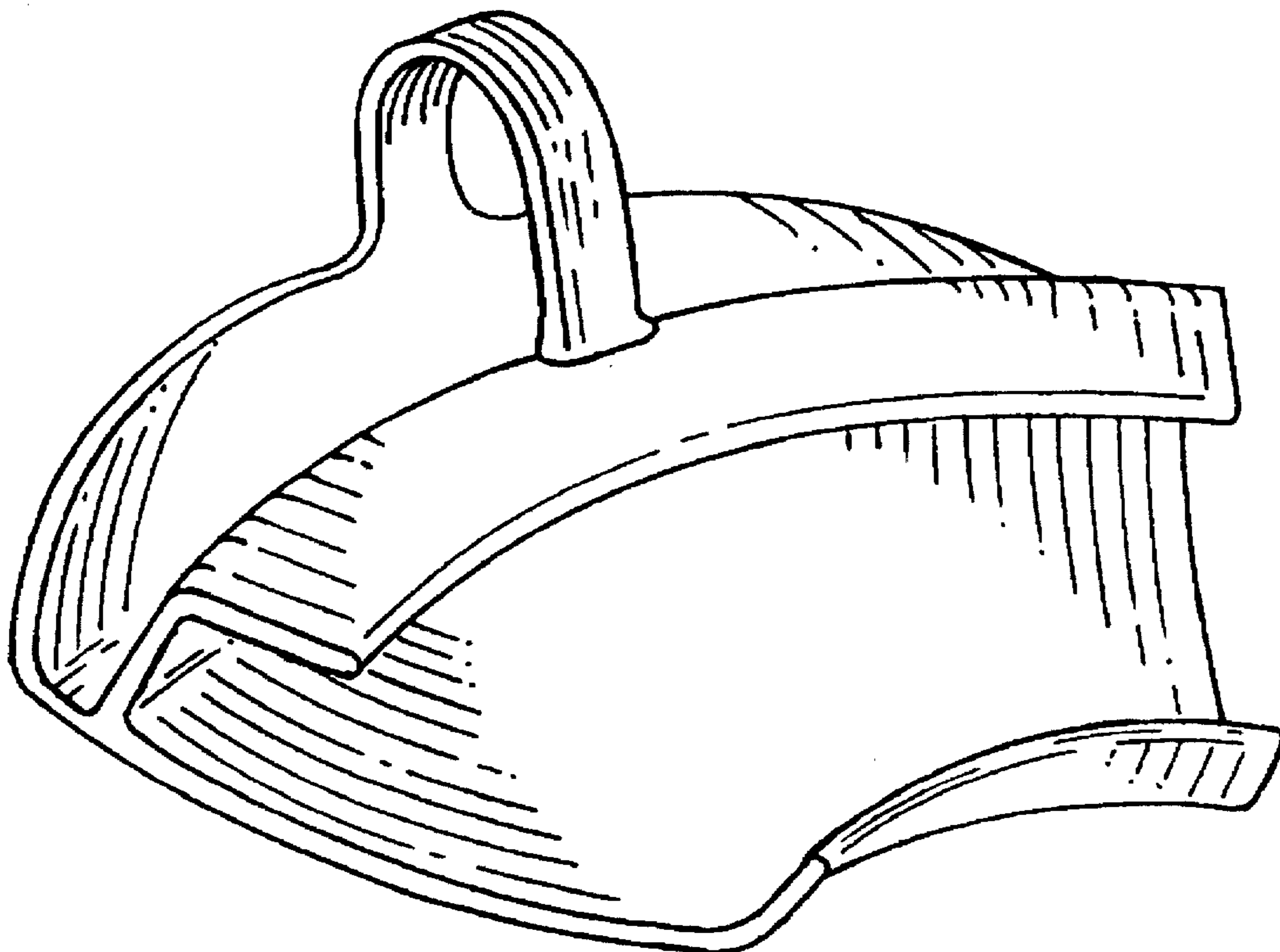

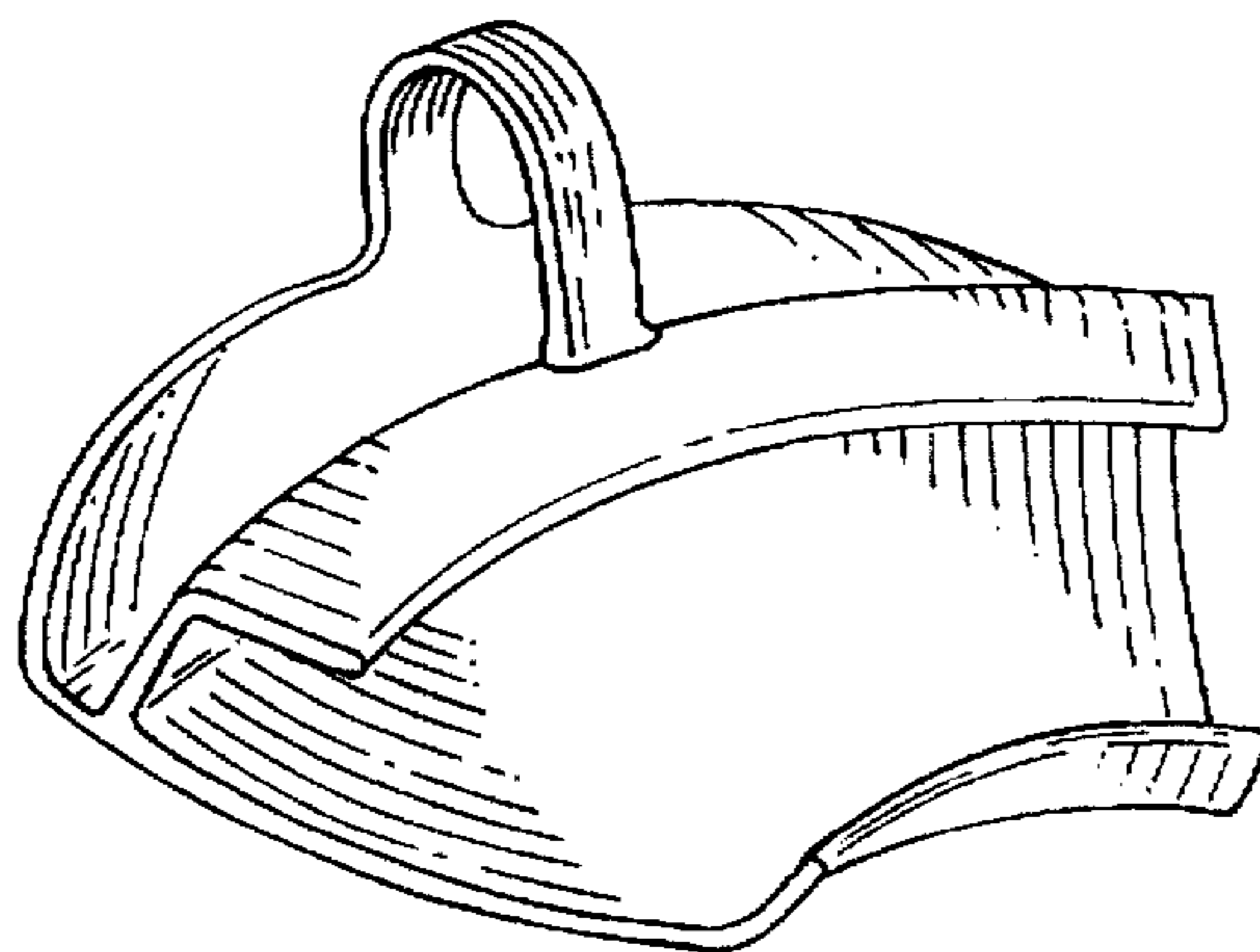

Fig. 1

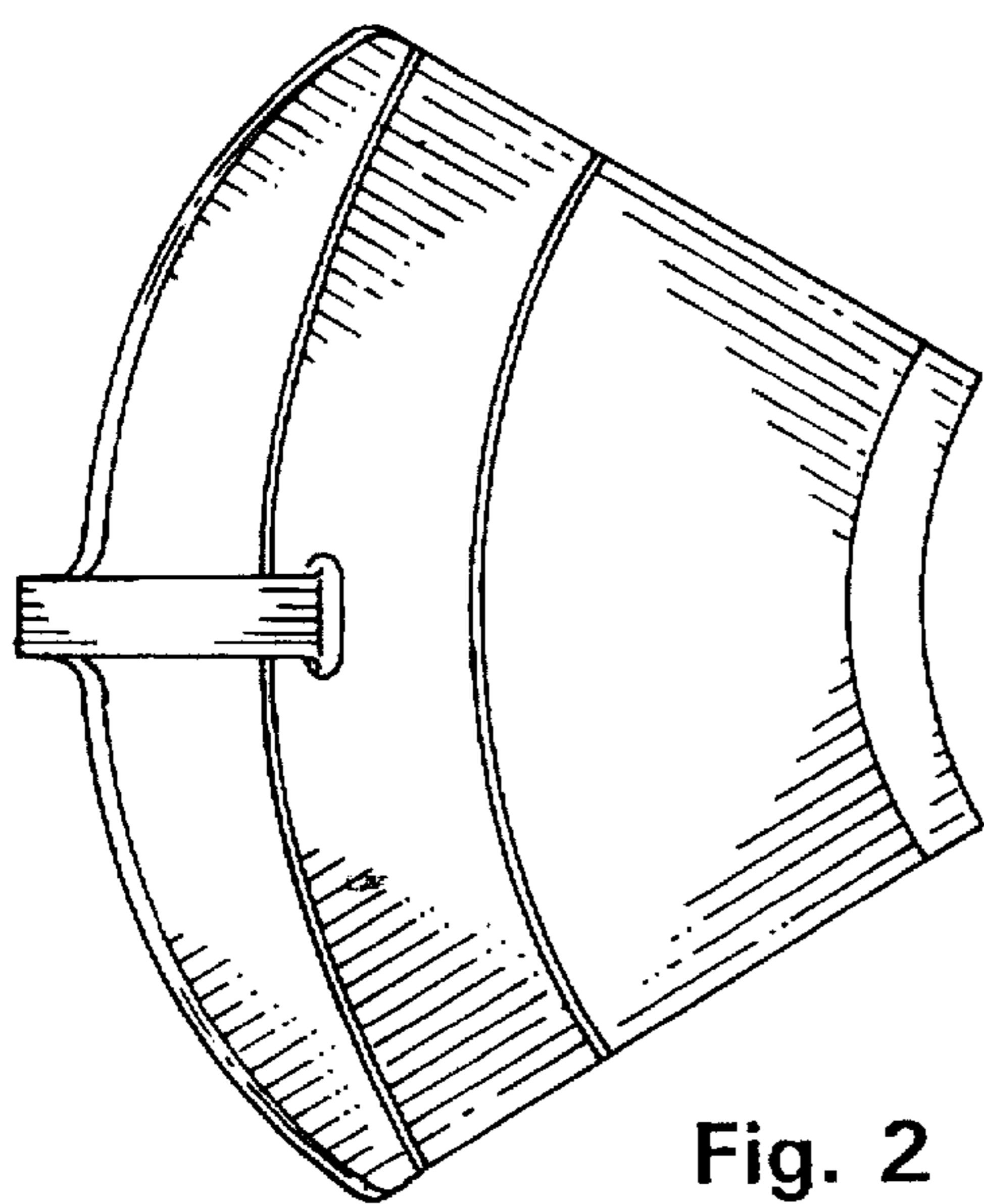

Fig. 2

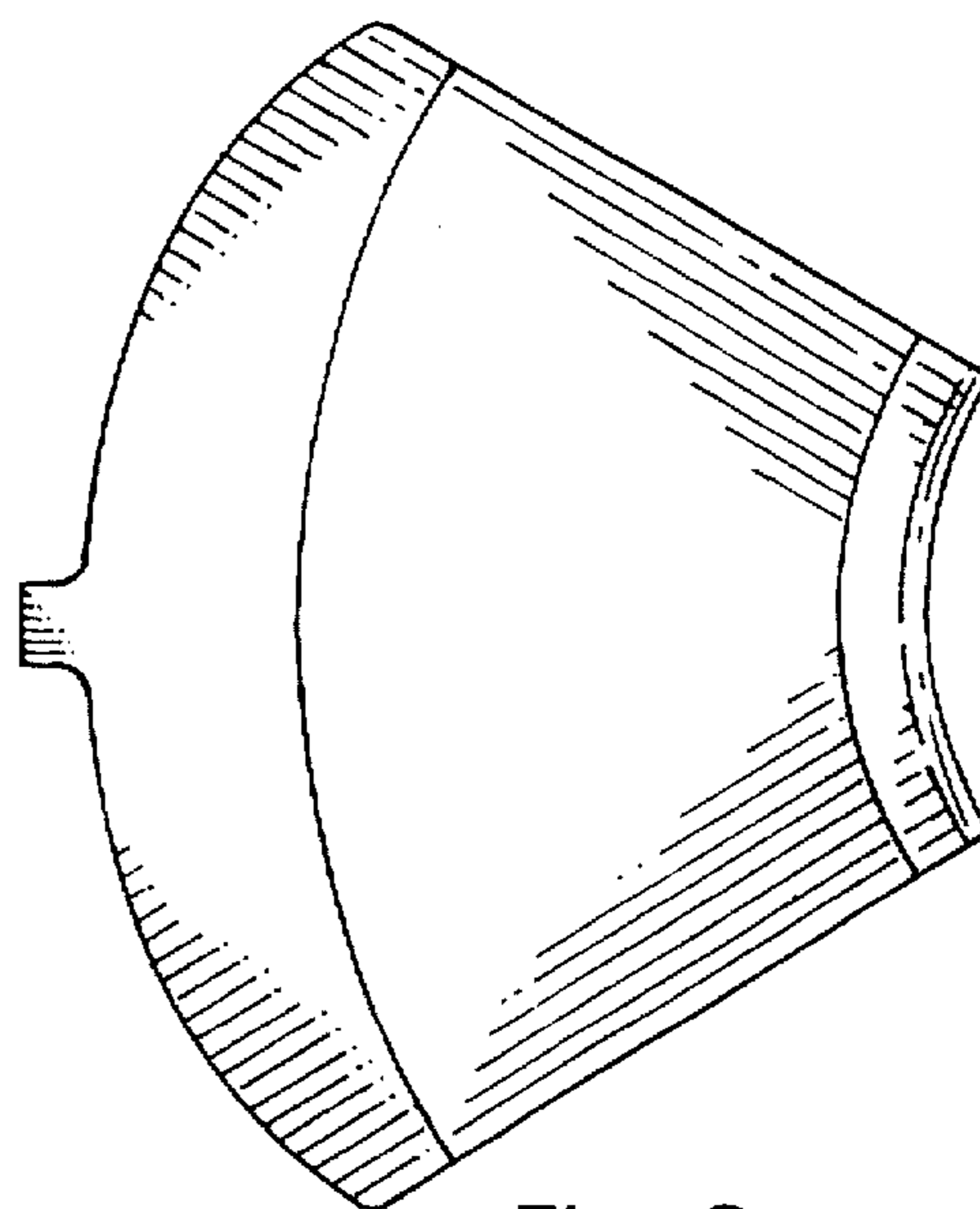

Fig. 3

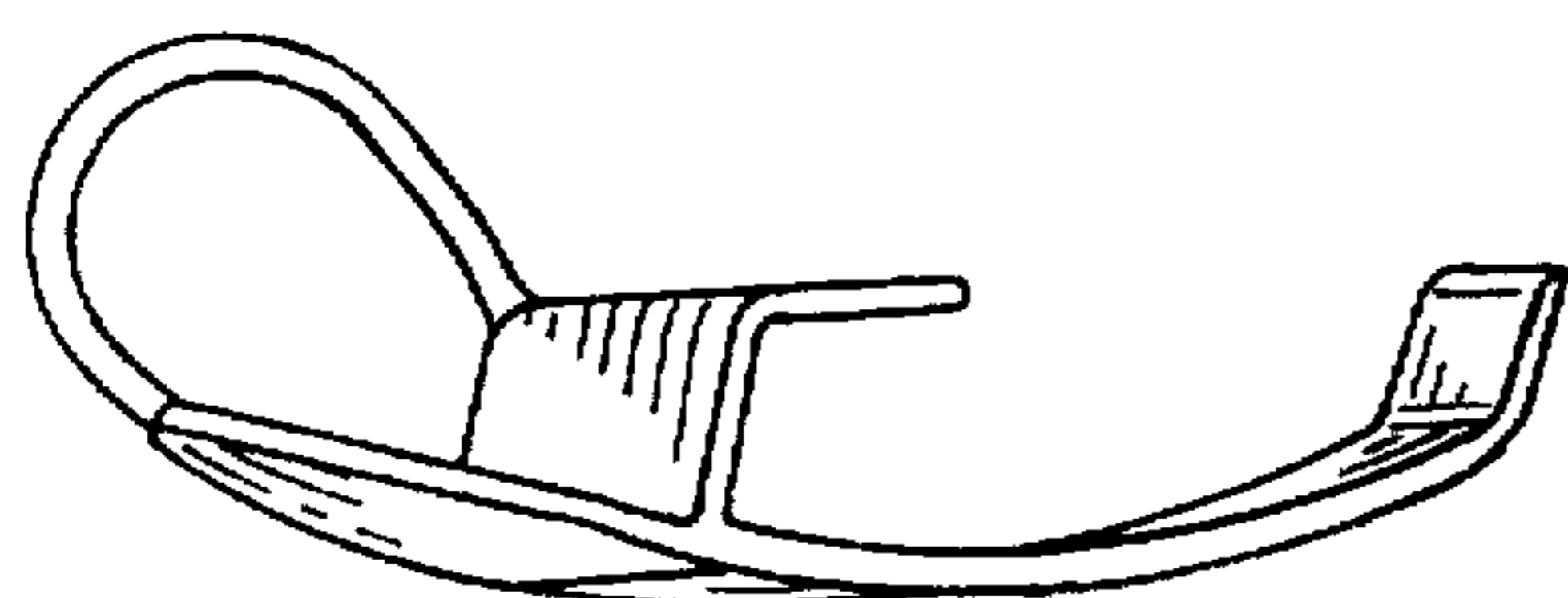

Fig. 4

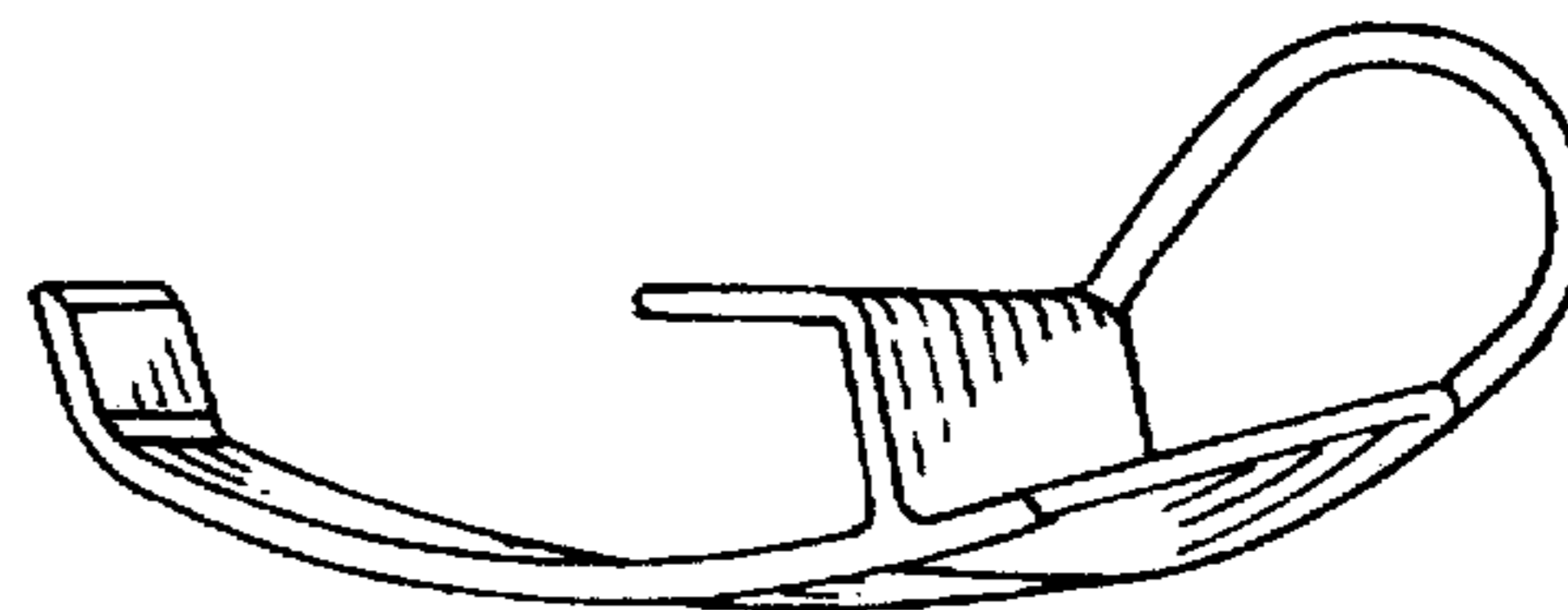

Fig. 5

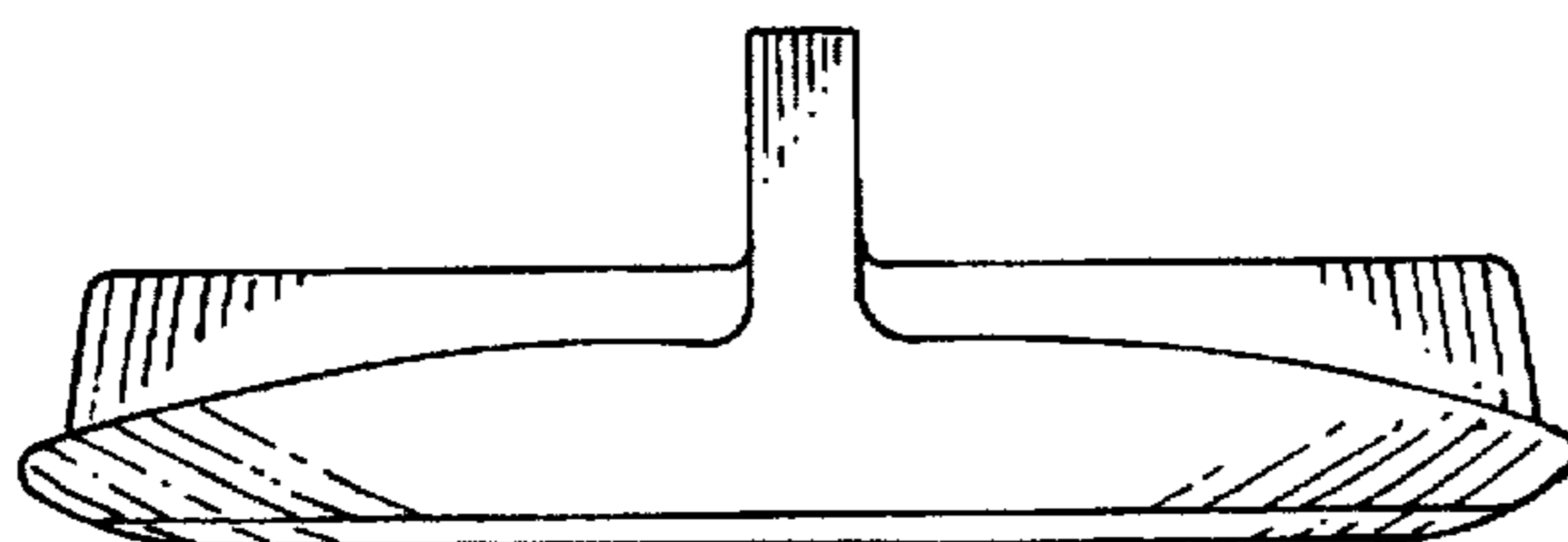

Fig. 6

Fig. 7

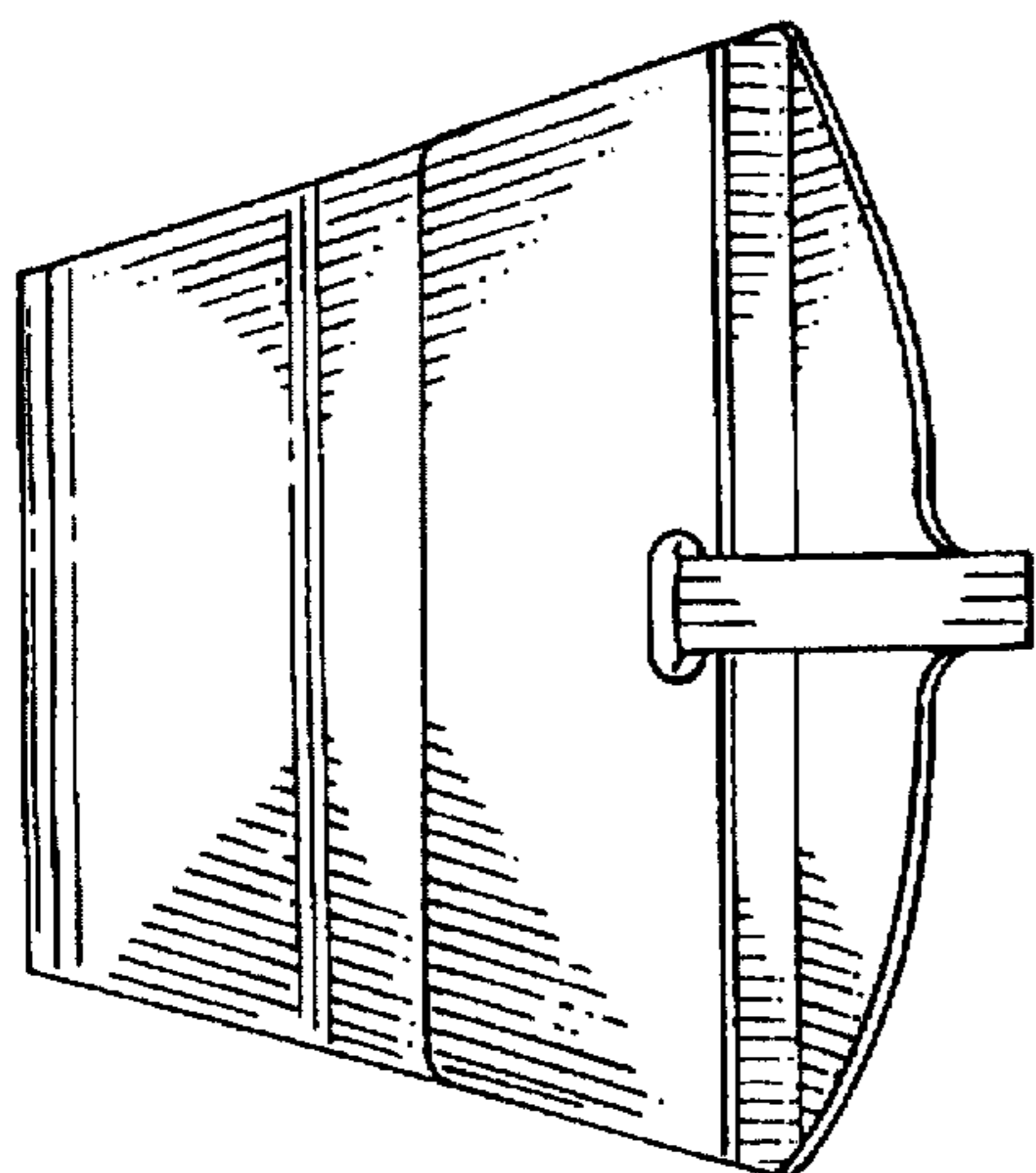
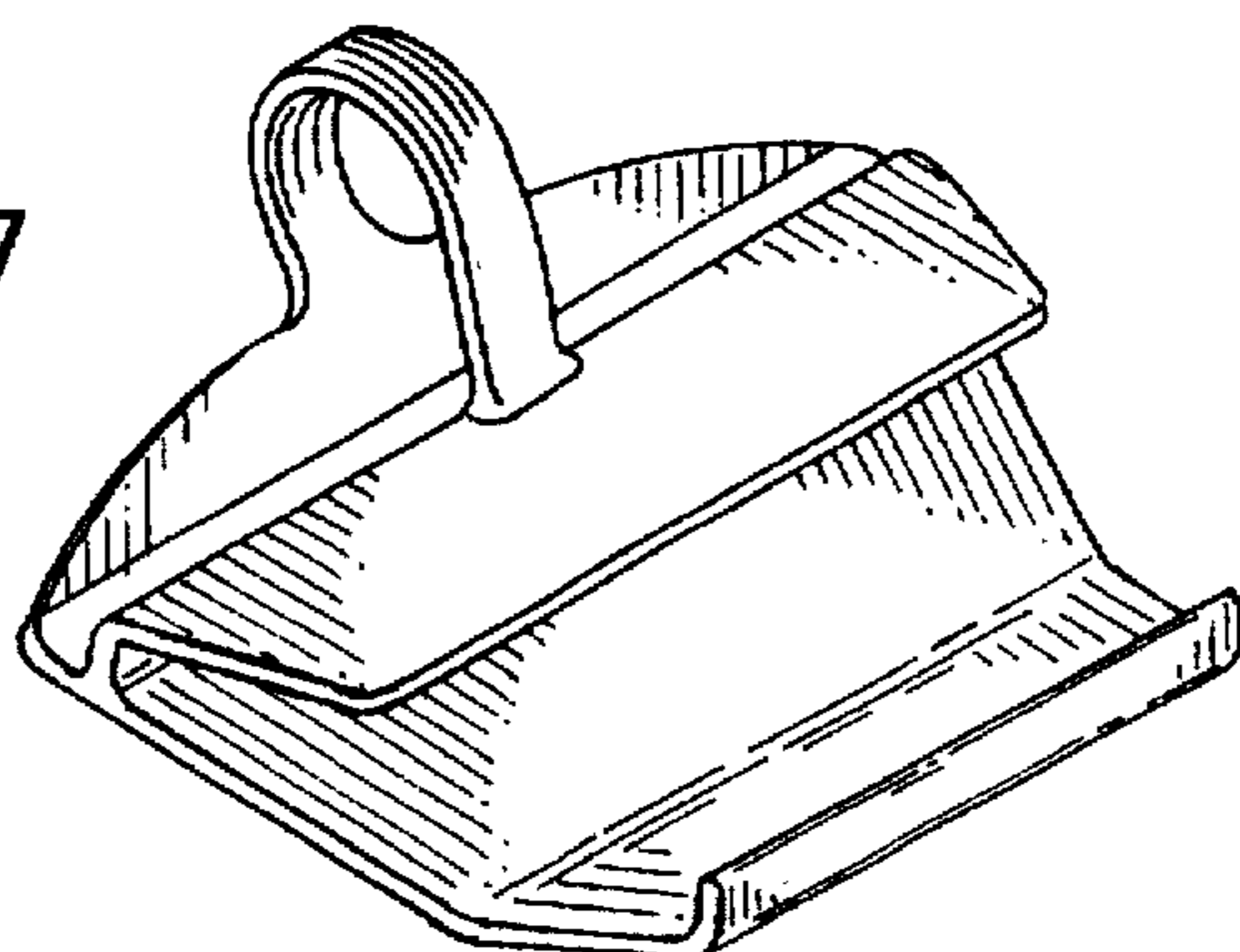

Fig. 8

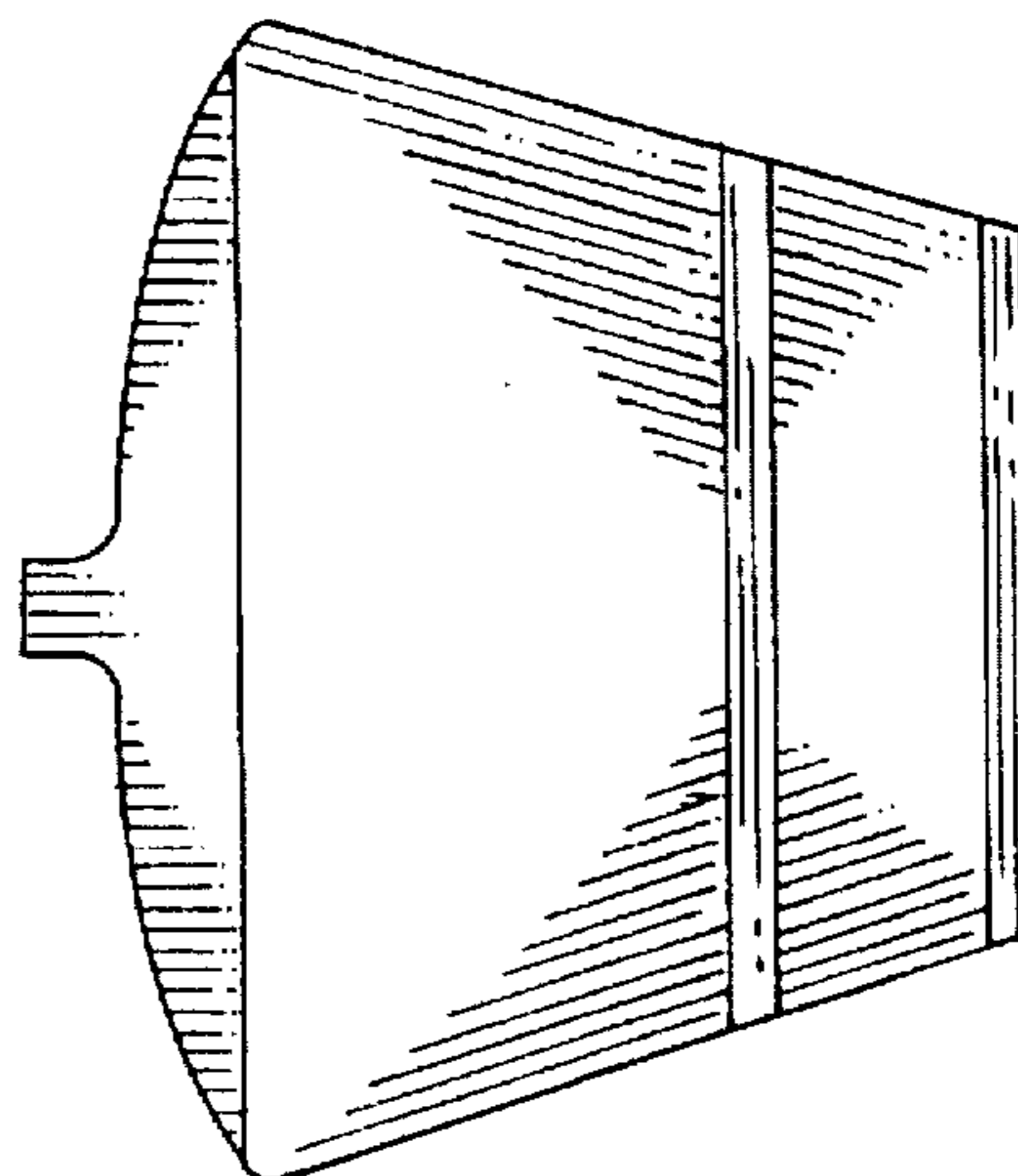

Fig. 9

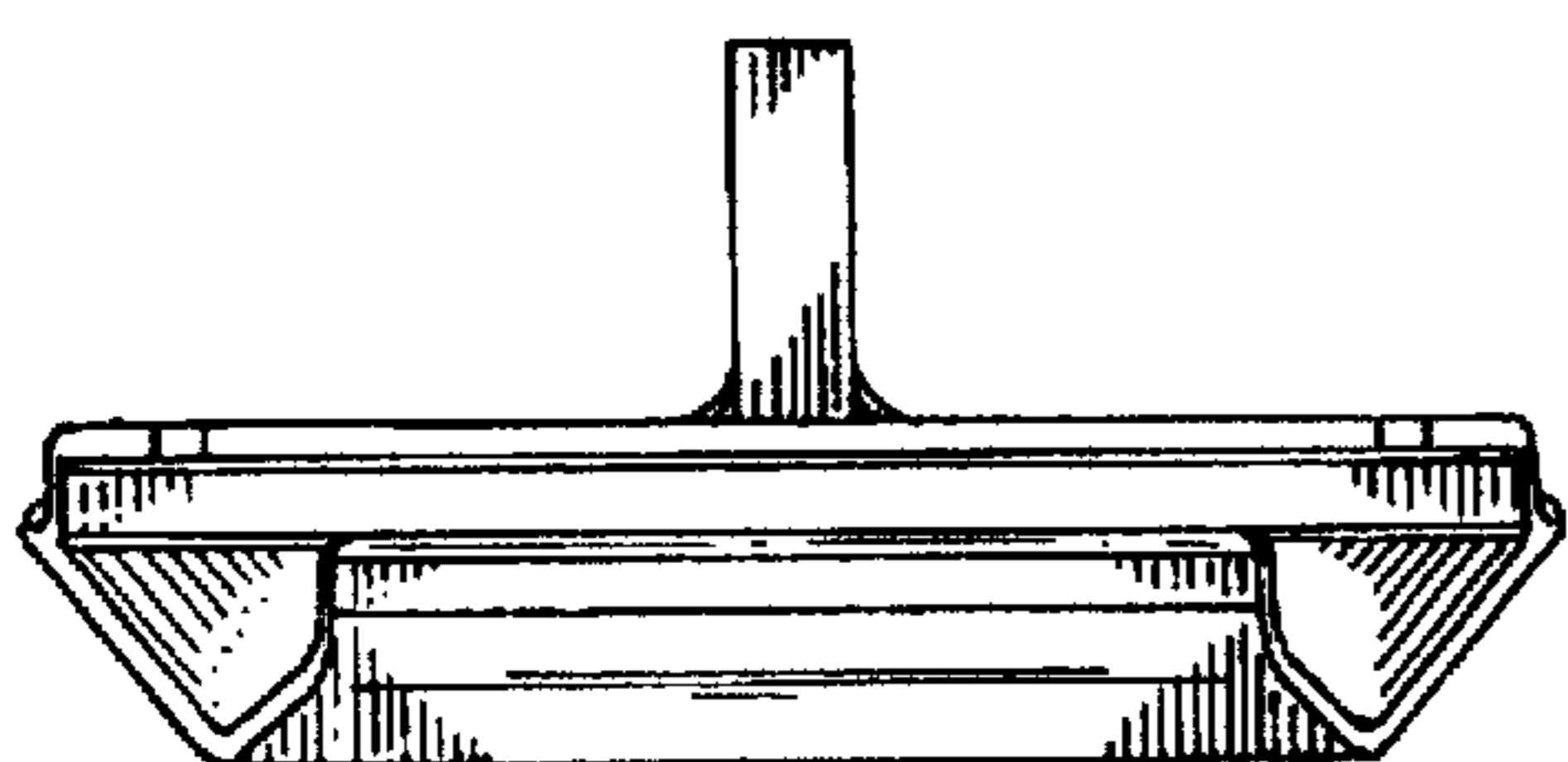

Fig. 10

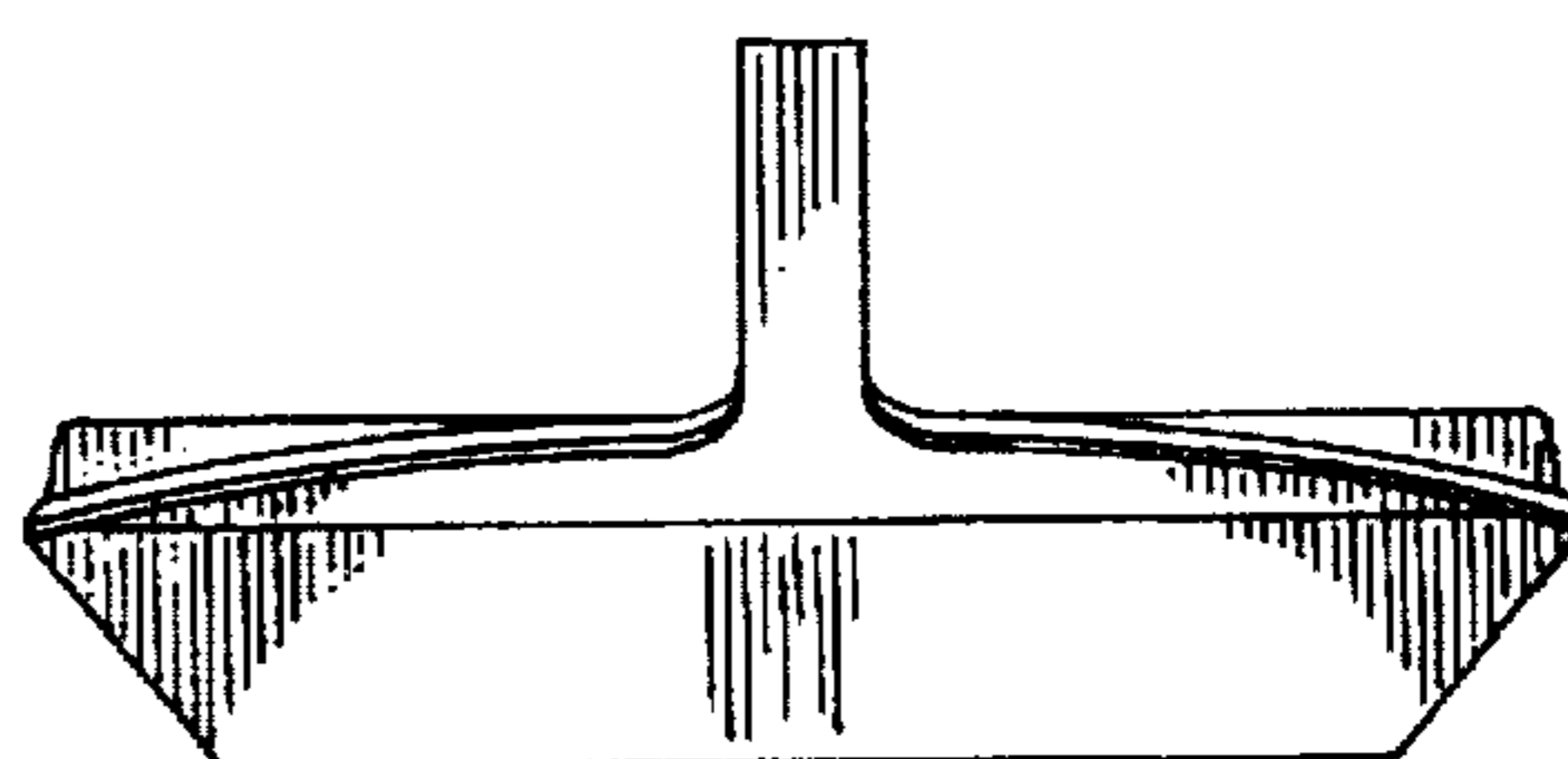

Fig. 11

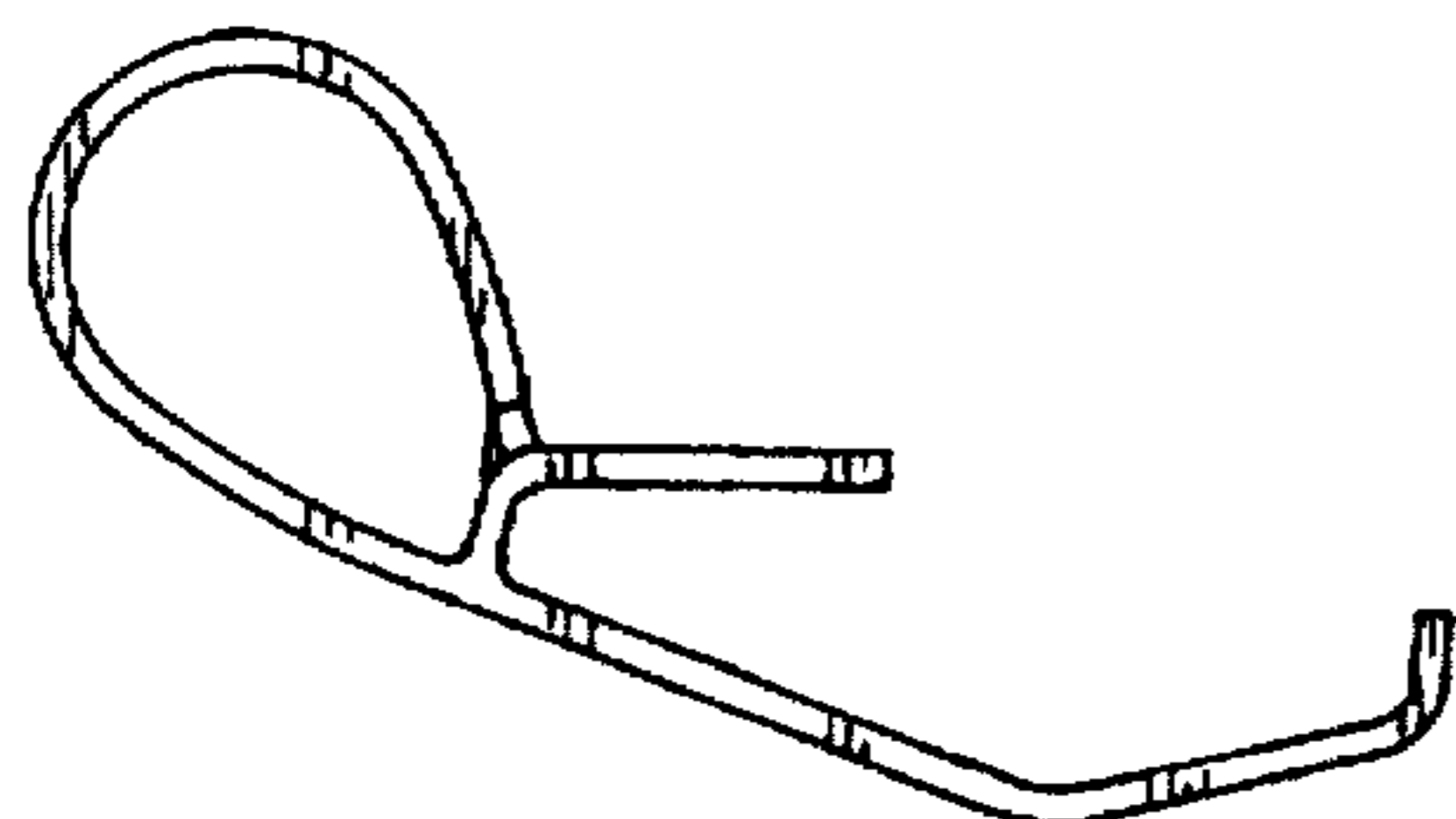

Fig. 12

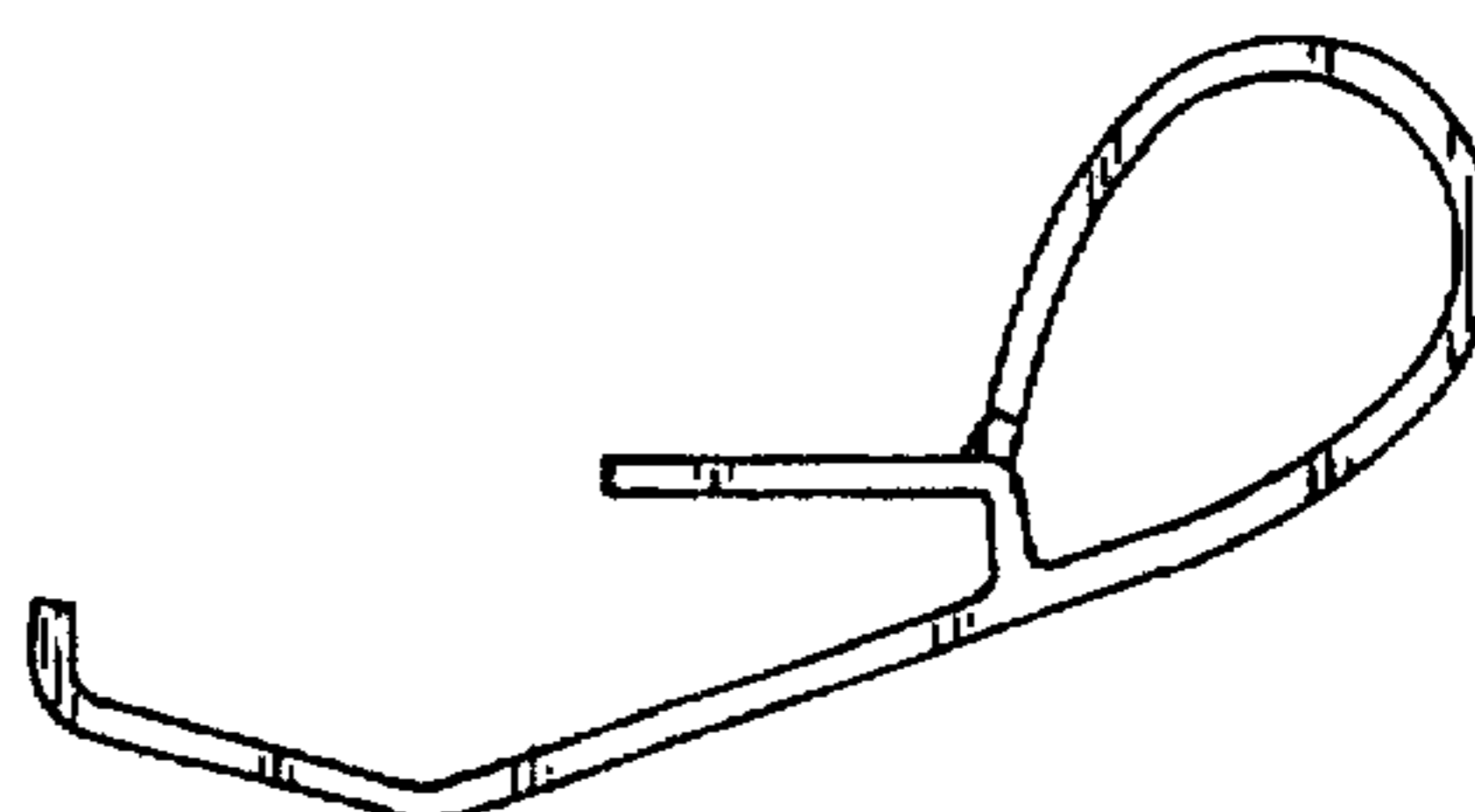

Fig. 13