



US00D393961S

United States Patent [19]

Whitehead et al.

[11] Patent Number: Des. 393,961

[45] Date of Patent: ***May 5, 1998

[54] MINI BALL RACK WITH FIVE POLES

[75] Inventors: Stephen P. Whitehead, Elgin;
Torrence Anderson; Michael G. Uffner, both of Naperville, all of Ill.

[73] Assignee: Suncoast Corporation, Batavia, Ill.

[*] Notice: The portion of the term of this patent subsequent to Mar. 5, 2010, has been disclaimed.

[**] Term: 14 Years

[21] Appl. No.: 51,180

[22] Filed: Mar. 5, 1996

[51] LOC (6) Cl. 20-02

[52] U.S. Cl. D6/464; D20/10; D20/42

[58] Field of Search D20/10; D6/552,
D6/449, 411, 475, 464, 567; 211/87, 35,
14, 105.1, 86, 34; 248/250; D8/376, 71

913,228	2/1909	McCarthy .	
929,519	7/1909	True .	
1,733,487	10/1929	Hackley .	
1,869,226	7/1932	Subick	248/215
2,060,760	11/1936	Keil	211/87
2,090,108	8/1937	Cicero	211/35
2,122,336	6/1938	Berry	211/88

(List continued on next page.)

FOREIGN PATENT DOCUMENTS

501564	4/1954	Canada .	
1272708	8/1961	France .	
1273324	8/1961	France .	
1274556	9/1961	France .	
1467884	12/1966	France .	
2609790	9/1976	Germany .	
096105	2/1988	Taiwan .	
15722	9/1909	United Kingdom .	
253810	6/1926	United Kingdom .	
261537	11/1926	United Kingdom .	
627398	8/1949	United Kingdom .	
2156199	10/1985	United Kingdom	A47B 96/02
WO 91/05693	5/1991	WIPO .	

Primary Examiner—Susan J. Lucas
Assistant Examiner—Jennifer Rivard
Attorney, Agent, or Firm—Thomas W. Tolpin

[56] References Cited

U.S. PATENT DOCUMENTS

D. 191,790	11/1961	Schaefer	D34/5
D. 198,349	6/1964	Saunders	D80/10
D. 203,513	1/1966	Warren	D34/5
D. 237,231	10/1975	Wells	D20/2
D. 240,421	7/1976	Rose	D6/4
D. 261,571	11/1981	Hanson	D3/38
D. 271,547	11/1983	Bowsher	D6/464
D. 283,472	4/1986	Wattles	D6/463
D. 283,568	4/1986	Valley	D6/429
D. 290,201	6/1987	Wilder	D6/464
D. 290,567	6/1987	Spicer	D6/567
D. 303,600	9/1989	Thompson et al.	D6/552
D. 309,226	7/1990	Wilcox	D6/552
D. 309,998	8/1990	Sumrell et al.	D6/567
D. 323,591	2/1992	Stravitz	D6/449 X
D. 325,133	4/1992	Stavitz	D6/449 X
D. 371,022	6/1996	Saper	D6/449
466,608	1/1892	Landis .	
797,614	8/1905	Schipkowsky .	
860,278	7/1907	Bokin .	

[57] CLAIM

The ornamental design for a mini ball rack with five poles, as shown and described.

DESCRIPTION

FIG. 1 is a perspective view of the mini ball rack with five poles invention;
FIG. 2 is an front view thereof;
FIG. 3 is a top view thereof;
FIG. 4 is a right end view, the left end view thereof forming a mirror image of said right side and thus is not shown; and
FIG. 5 is a bottom view thereof;
FIG. 6 is a back view thereof; and,
FIG. 7 is a cross-sectional view thereof taken along line 7—7 of FIG. 1.

1 Claim, 4 Drawing Sheets

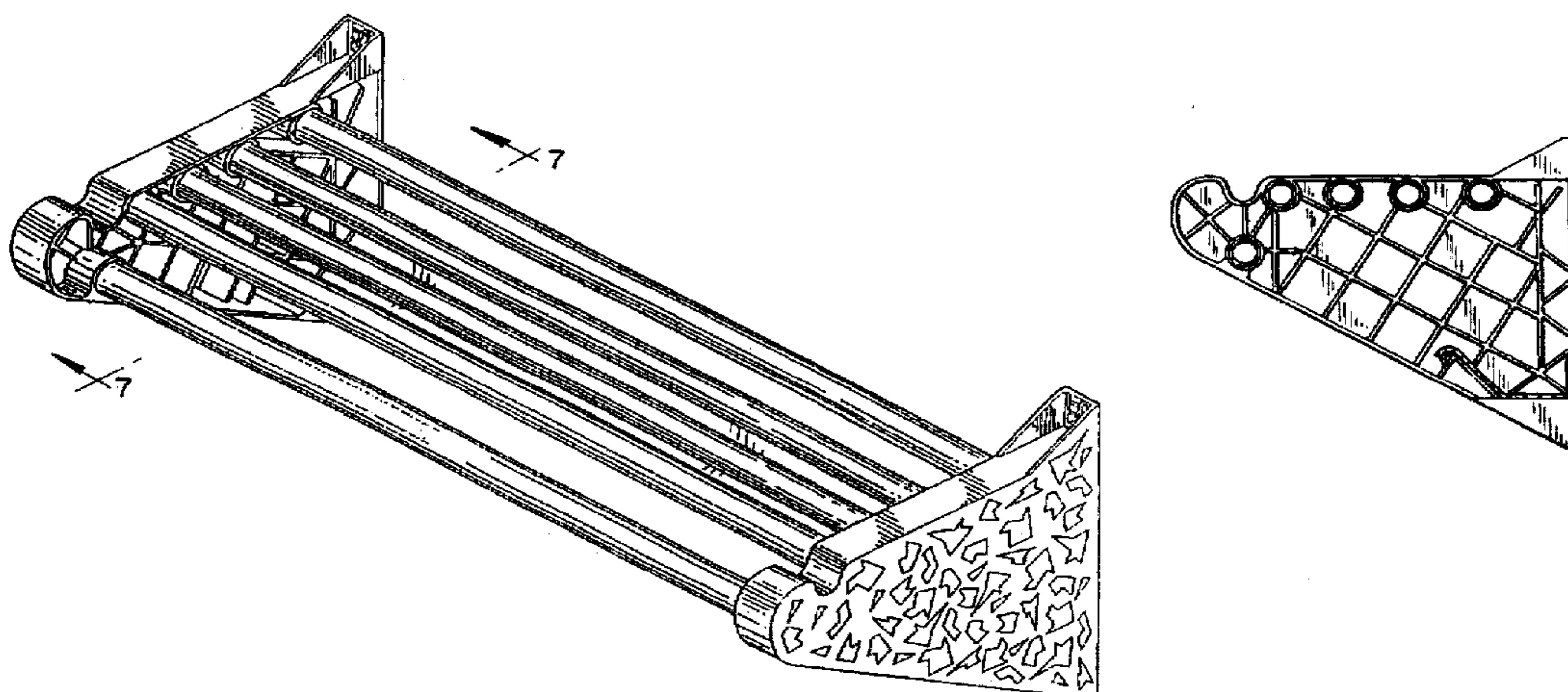

U.S. PATENT DOCUMENTS					
2,271,784	2/1942	Tritt 248/220	4,227,710	10/1980	Laub 280/47
2,633,998	4/1953	Derman 211/104	4,315,633	2/1982	Boeddekker et al. 280/79.3
2,767,854	10/1956	Barrett 211/13	4,376,521	3/1983	Walters 248/206
2,885,090	5/1959	Forman et al. 211/175	4,561,547	12/1985	Estwanik, III 211/14
2,930,486	3/1960	Hoover 211/44	4,583,647	4/1986	Schinzing 211/60.1
2,950,003	8/1960	Simmons et al. 206/75	4,629,065	12/1986	Braaten 206/315.1
2,972,417	2/1961	Smith 211/71	4,633,789	1/1987	Kortering et al. 108/152
3,220,363	11/1965	Gingher 108/144	4,643,317	2/1987	Wilkinson et al. 211/14
3,565,020	2/1971	Schier 108/152	4,674,967	6/1987	Oseka 425/110
3,650,407	3/1972	Benham, Jr. 211/14	4,676,539	6/1987	Potocnjak 294/67.4
3,669,395	6/1972	Gehrke 248/235	4,678,087	7/1987	York 211/70.5
3,698,563	10/1972	Gordon et al. 211/13	4,708,310	11/1987	Smith 248/220
3,788,241	1/1974	Ravreby 108/6	4,776,650	10/1988	Ferenzi 312/245
3,869,137	3/1975	Byrom 280/47.19	4,854,456	8/1989	Lee 211/14
3,888,353	6/1975	Leifheit 211/37	4,863,082	9/1989	Evans et al. 244/42
3,997,060	12/1976	Kunin 211/126	4,871,074	10/1989	Bryson et al. 211/13
4,002,241	1/1977	Parrilla, Sr. 211/88	4,936,467	6/1990	Bobeczko 211/14
4,049,126	9/1977	Halverson 211/104	5,014,948	5/1991	Asaro et al. 248/215
4,154,442	5/1979	Trubody et al. 273/29	5,188,246	2/1993	Maxworthy 211/153
4,162,013	7/1979	Tucker 211/43	5,203,462	4/1993	Brooks 211/14
4,178,844	12/1979	Ward et al. 99/449	5,253,837	10/1993	Loux 248/250
4,188,890	2/1980	deVillers 108/30	5,294,005	3/1994	Hedges 211/13
4,193,495	3/1980	Keeley 206/315	5,325,973	7/1994	Reedy 211/18
			5,413,228	5/1995	Le Clerc 211/87

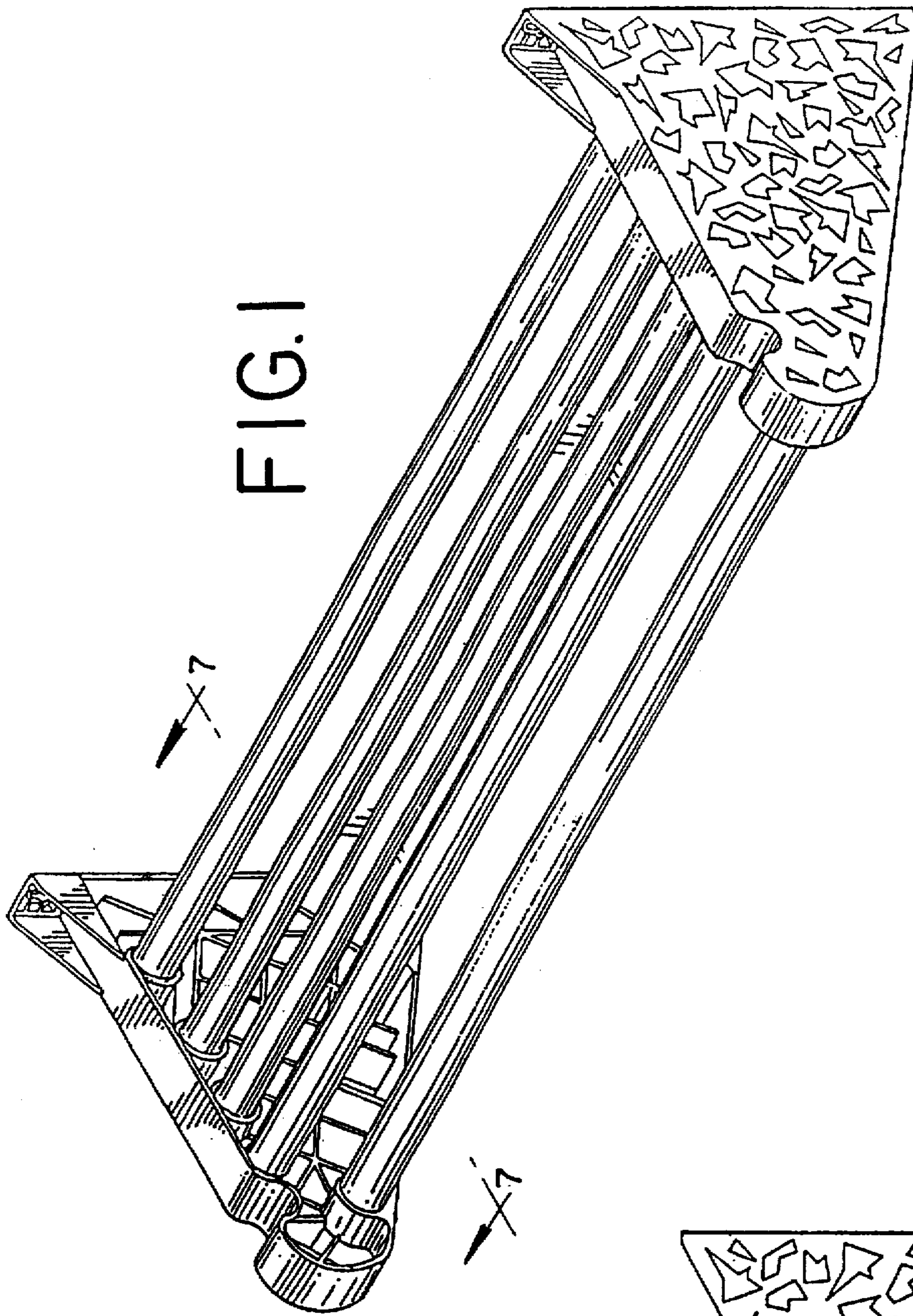

FIG. 1

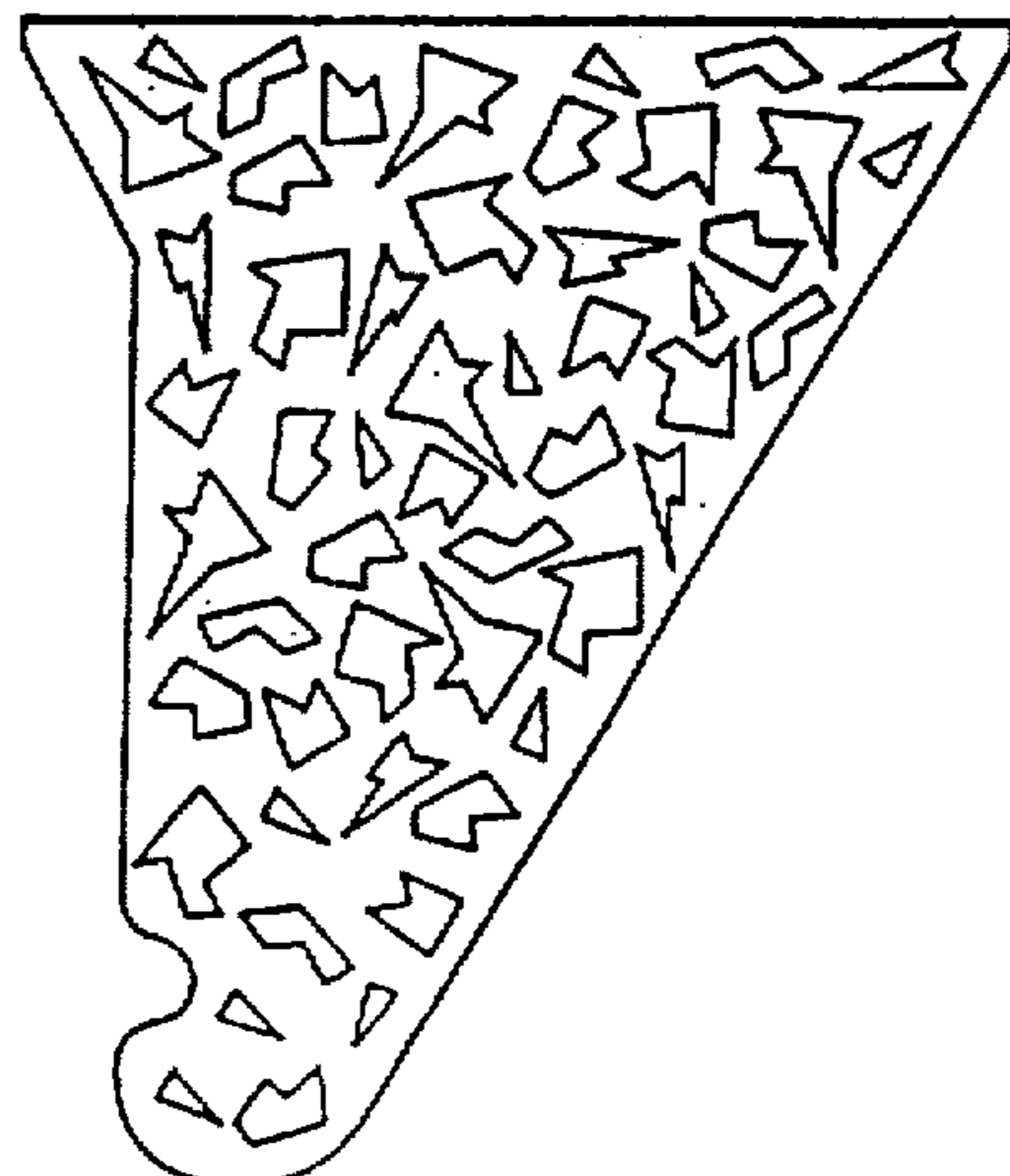

FIG. 4

FIG. 2

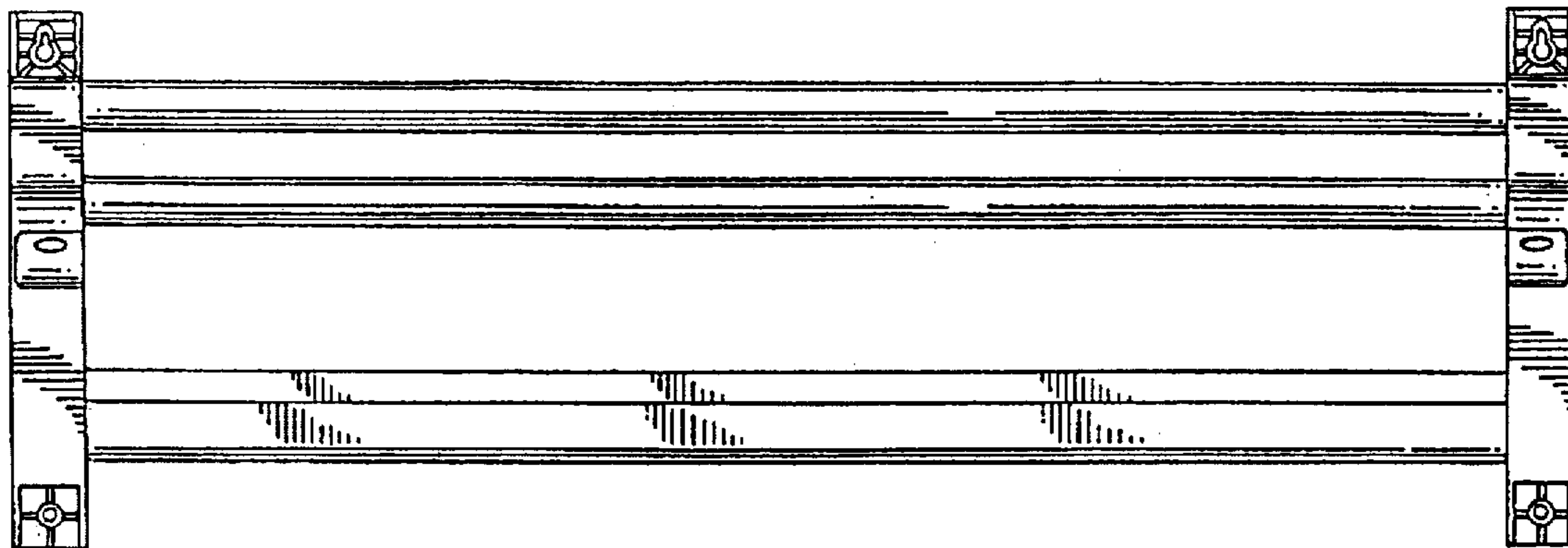

FIG. 3

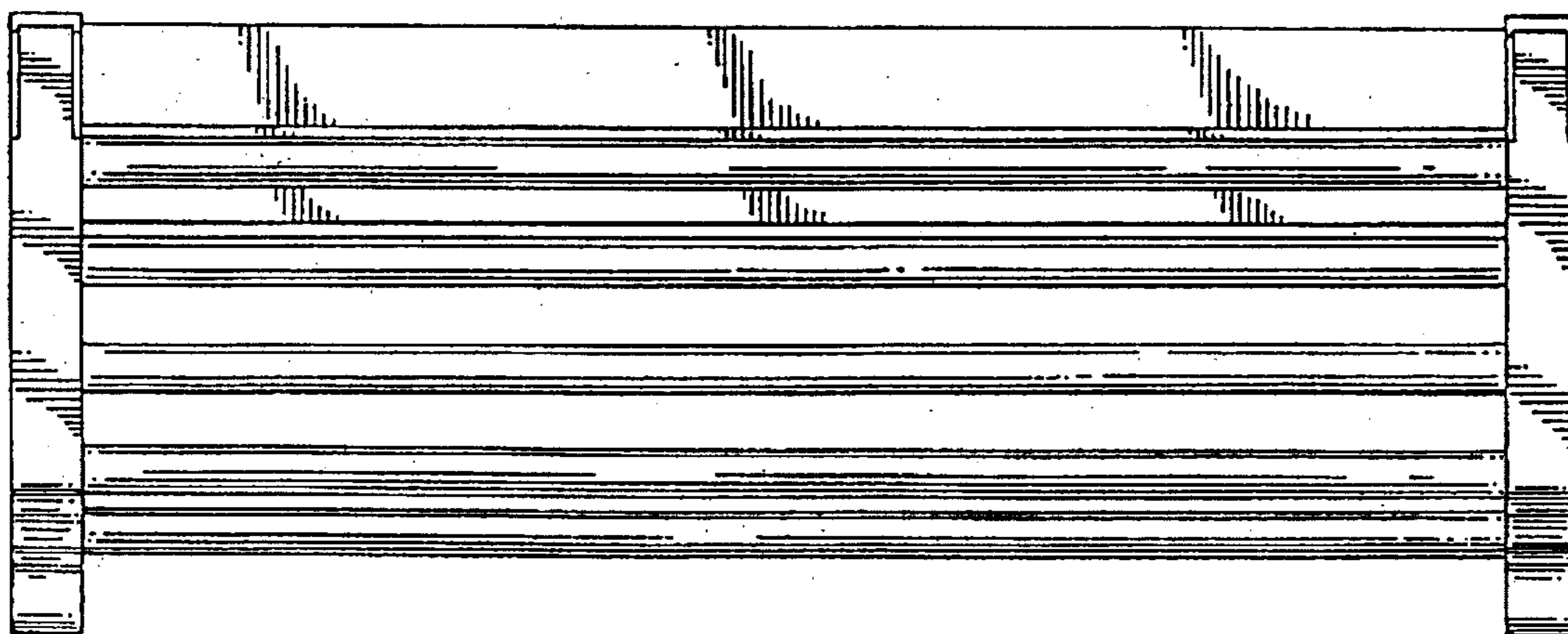

FIG. 5

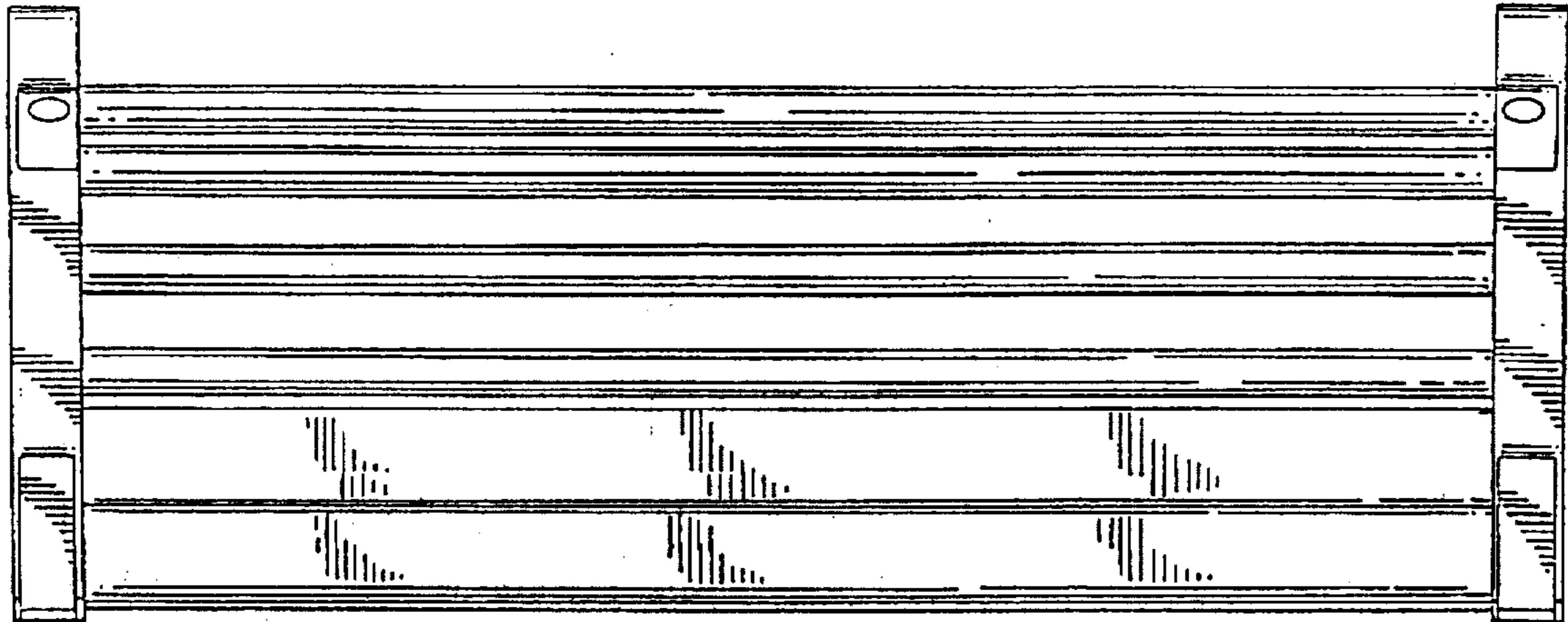

FIG. 6

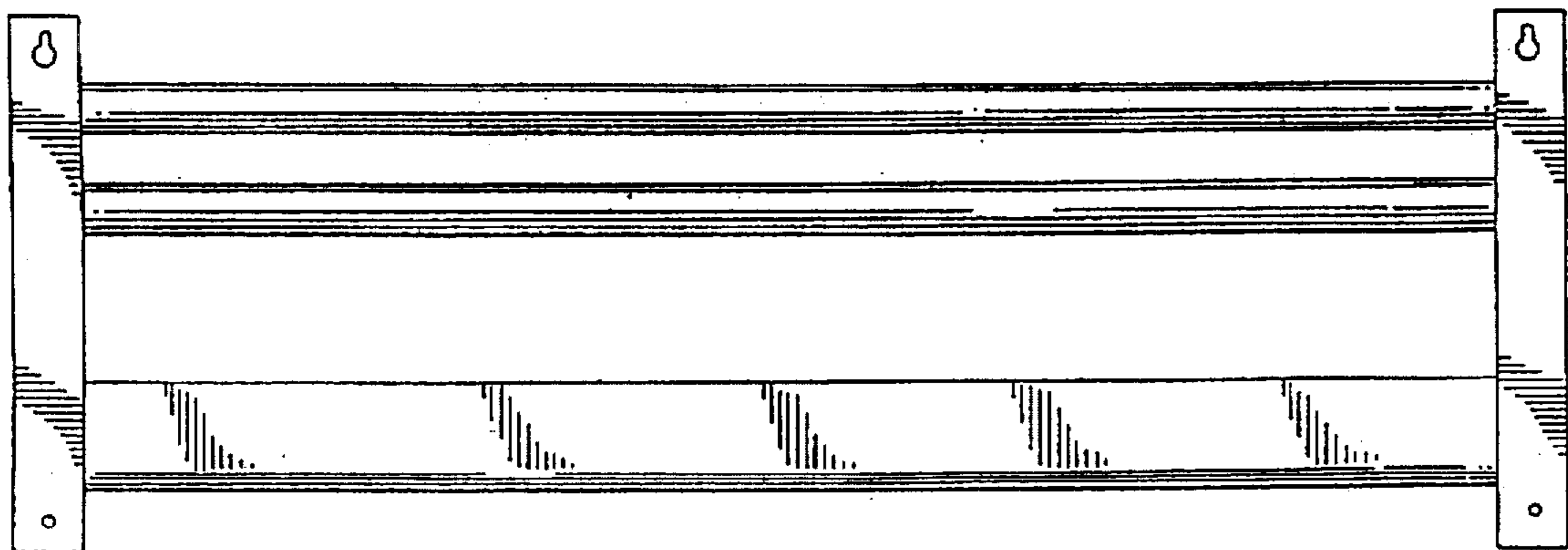

FIG. 7

