



US00D393943S

# United States Patent [19]

[11] Patent Number: Des. 393,943

Franklin et al.

[45] Date of Patent: \*\*May 5, 1998

## [54] TOOL TOTE BUCKET

## DESCRIPTION

[76] Inventors: **Ronnie P. Franklin**, Rte. 4 Box 1674., Bainbridge; **Hugh D. Bailey**, Colquitt Highway Box 2465, Colquitt, both of Ga. 31717

[\*\*] Term: 14 Years

[21] Appl. No.: 66,681

[22] Filed: Feb. 19, 1997

### Related U.S. Application Data

[63] Continuation-in-part of Ser. No. 63,013, Nov. 21, 1996.

[51] LOC (6) Cl. .... 03-01

[52] U.S. Cl. .... D3/273; D3/302; D3/905

[58] Field of Search ..... D3/294, 272, 273, D3/905, 302; D9/420, 424, 425; 206/349, 372, 373, 315.11, 508; D12/424, 425

### [56] References Cited

#### U.S. PATENT DOCUMENTS

D. 299,315	1/1989	Kasanda	.....	D9/424
D. 312,157	11/1990	Sjolander	.....	D3/276
D. 338,329	8/1993	Cornwall	.....	D9/424
D. 353,047	12/1994	Lackie	.....	D3/905
D. 355,828	2/1995	Dickinson et al.	.....	D3/281
D. 365,506	12/1995	Spitere	.....	D3/905
D. 372,125	7/1996	Frazier	.....	D3/905
D. 373,247	9/1996	Dickinson et al.	.....	D9/424
5,386,922	2/1995	Jordan	.....	206/373

Primary Examiner—Philip S. Hyder

### [57] CLAIM

The ornamental design for a tool tote bucket, as shown and described.

FIG. 1 is a front elevational of the tool tote bucket showing our new design;  
 FIG. 2 is a rear elevational view thereof;  
 FIG. 3 is a left side elevational view thereof;  
 FIG. 4 is a right side elevational view thereof;  
 FIG. 5 is a top plan view thereof;  
 FIG. 6 is a bottom plan view thereof;  
 FIG. 7 is a cross-sectional view thereof taken along line 7—7 of FIG. 1;  
 FIG. 8 is a cross-sectional view thereof taken along line 8—8 of FIG. 1;  
 FIG. 9 is a front elevational view of an alternative embodiment thereof;  
 FIG. 10 is a rear elevational view thereof;  
 FIG. 11 is a left side elevational view thereof;  
 FIG. 12 is a right side elevational view thereof;  
 FIG. 13 is a top plan view thereof;  
 FIG. 14 is a bottom plan view thereof;  
 FIG. 15 is a cross-sectional view thereof taken along line 15—15 of FIG. 9;  
 FIG. 16 is a cross-sectional view thereof taken along line 16—16 of FIG. 9;  
 FIG. 17 is another alternative embodiment thereof;  
 FIG. 18 is a rear elevational view thereof;  
 FIG. 19 is a left side elevational view thereof;  
 FIG. 20 is a right side elevational view thereof;  
 FIG. 21 is a top plan view thereof;  
 FIG. 22 is a bottom plan view thereof;  
 FIG. 23 is a cross-sectional view thereof taken along line 23—23 of FIG. 17; and,  
 FIG. 24 is a cross-sectional view thereof taken along line 24—24 of FIG. 17.

1 Claim, 6 Drawing Sheets

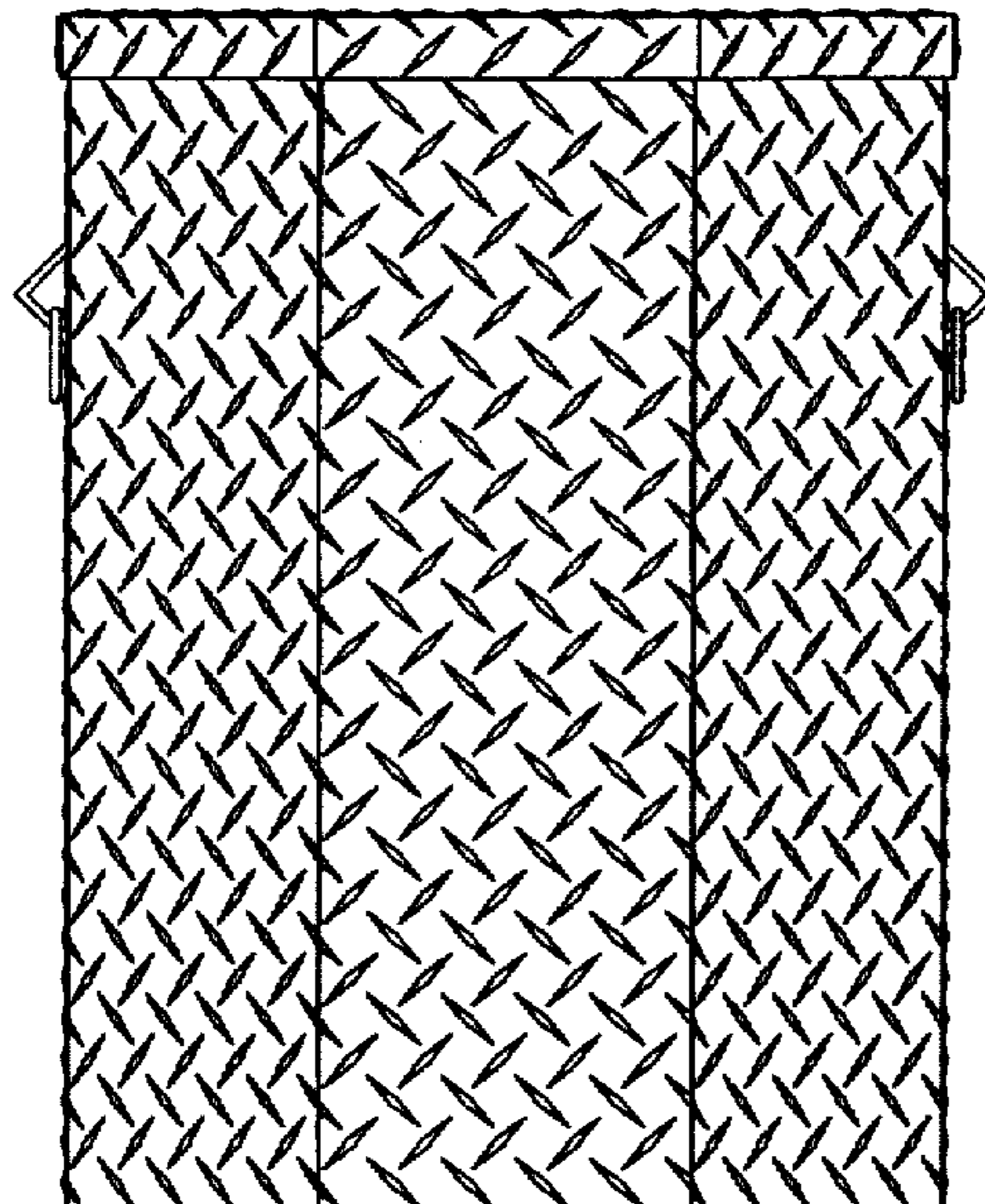

FIG. 1

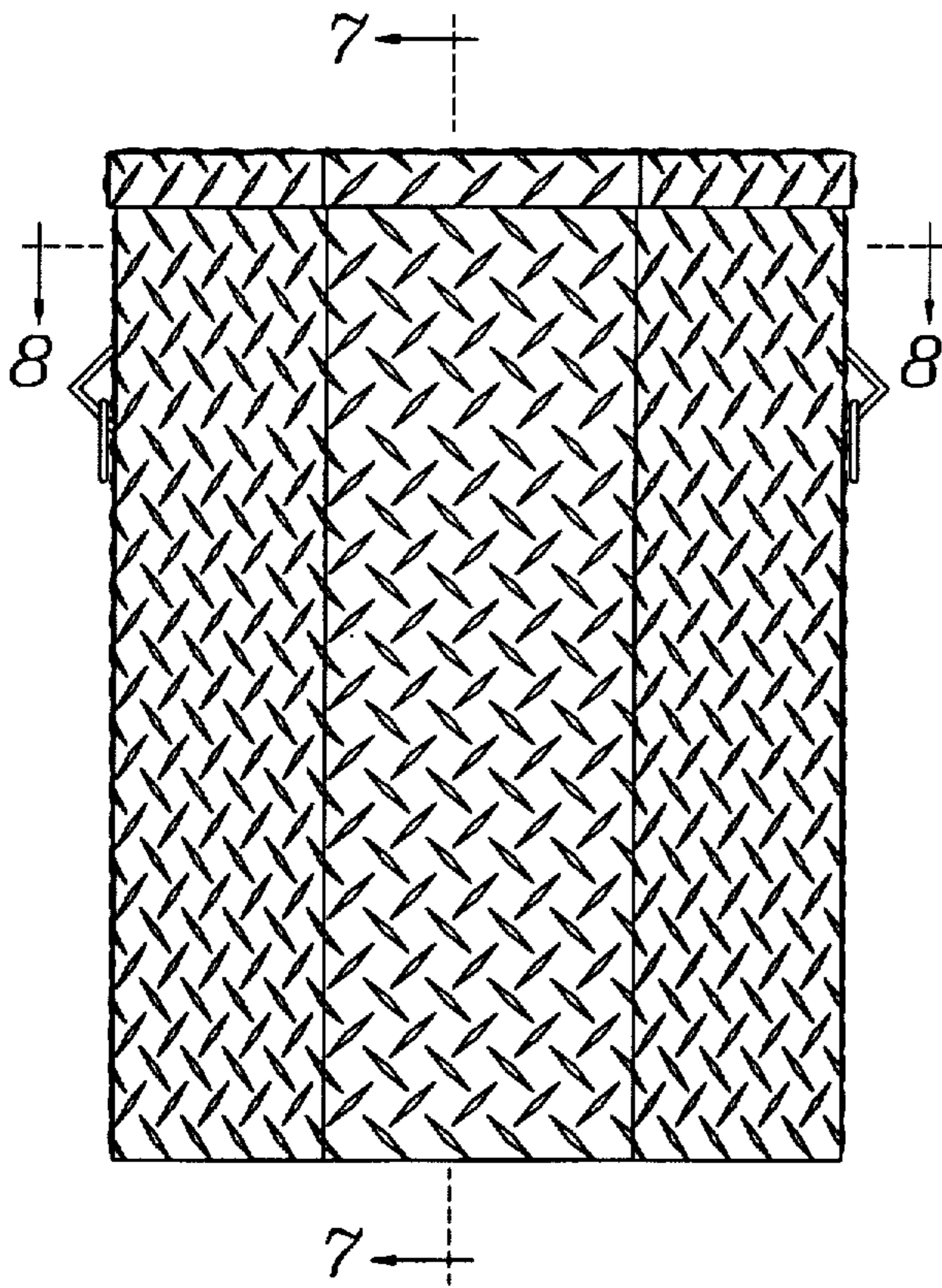

FIG. 2

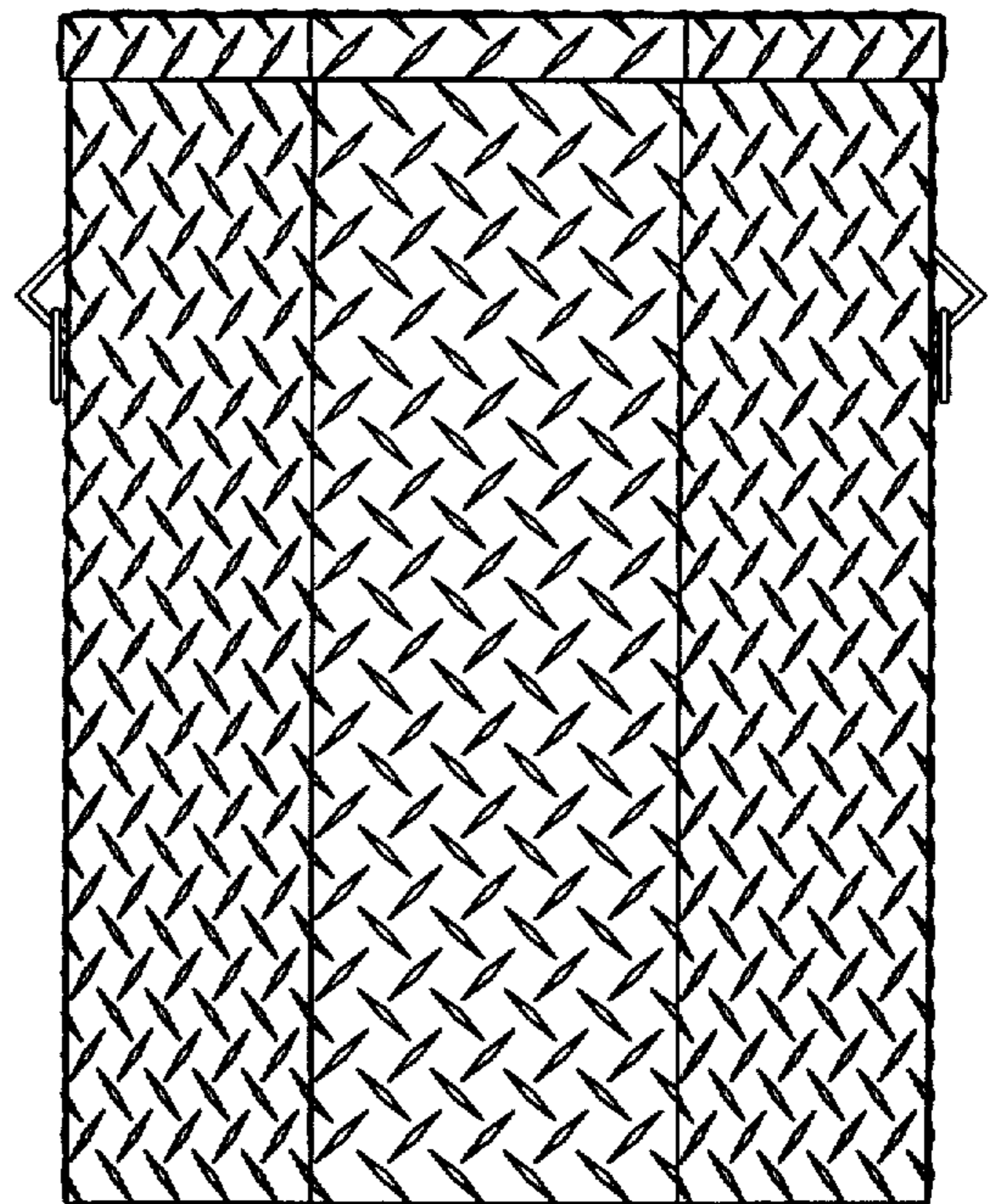

FIG. 3

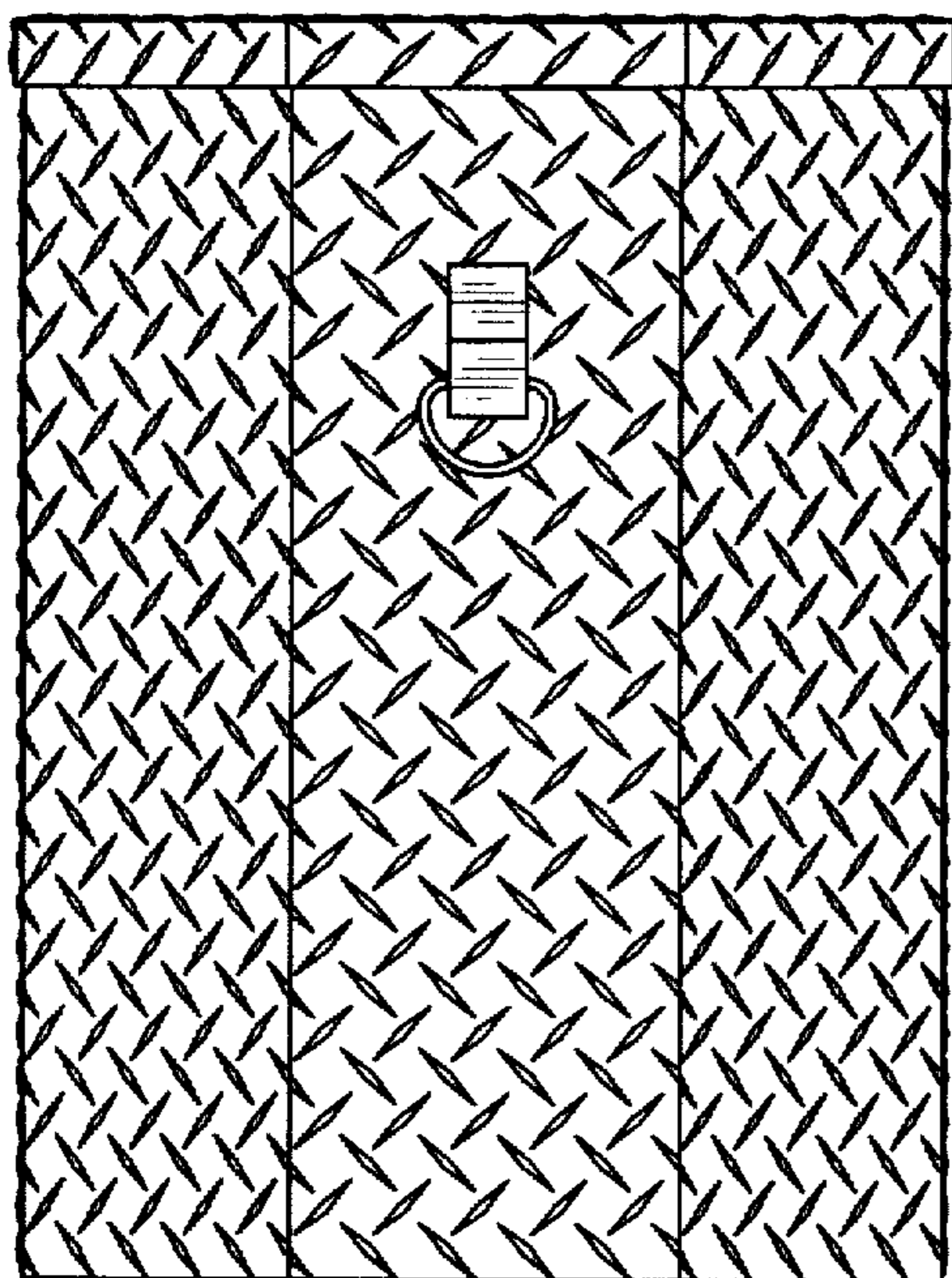

FIG. 4

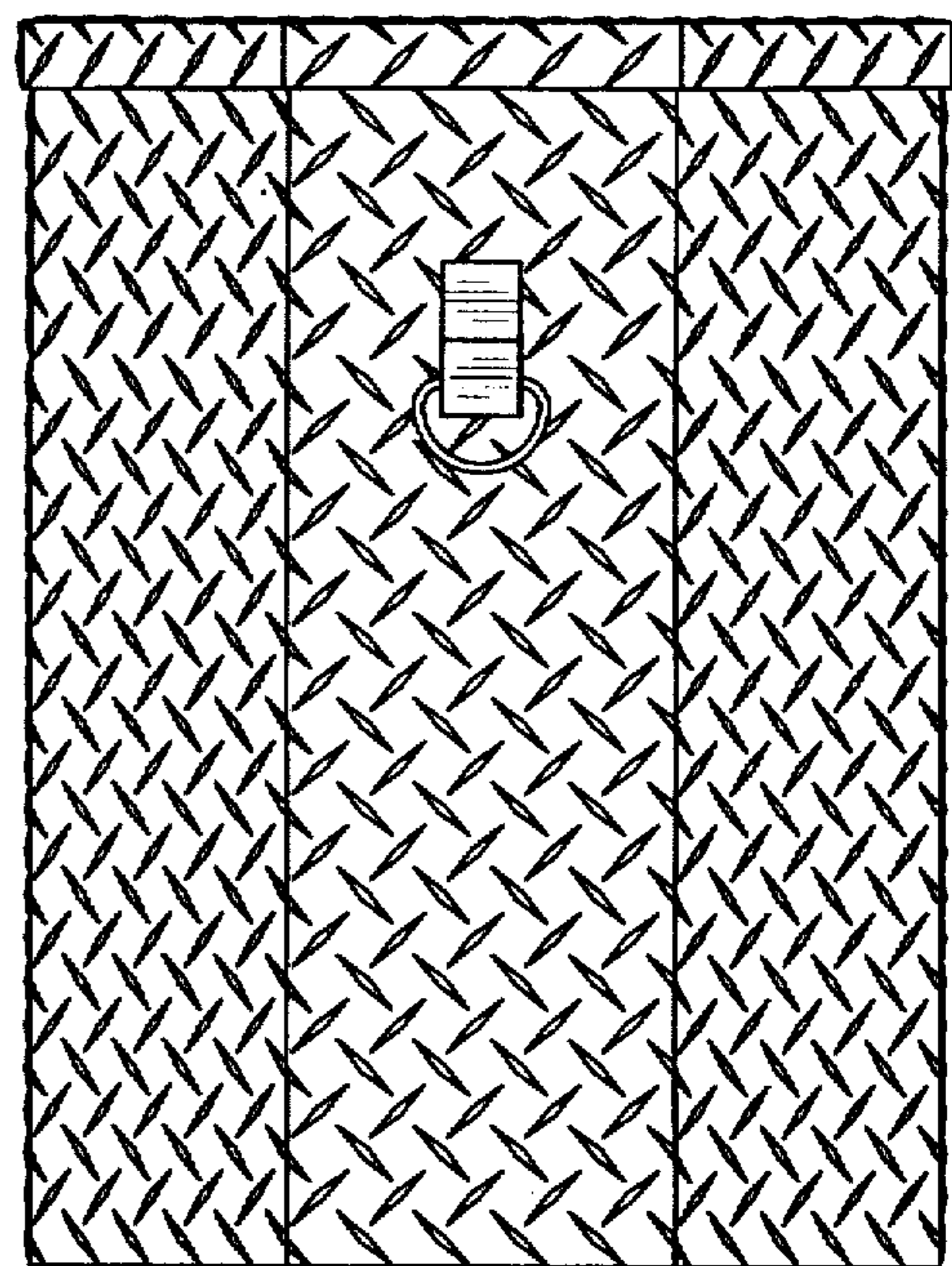

FIG. 5

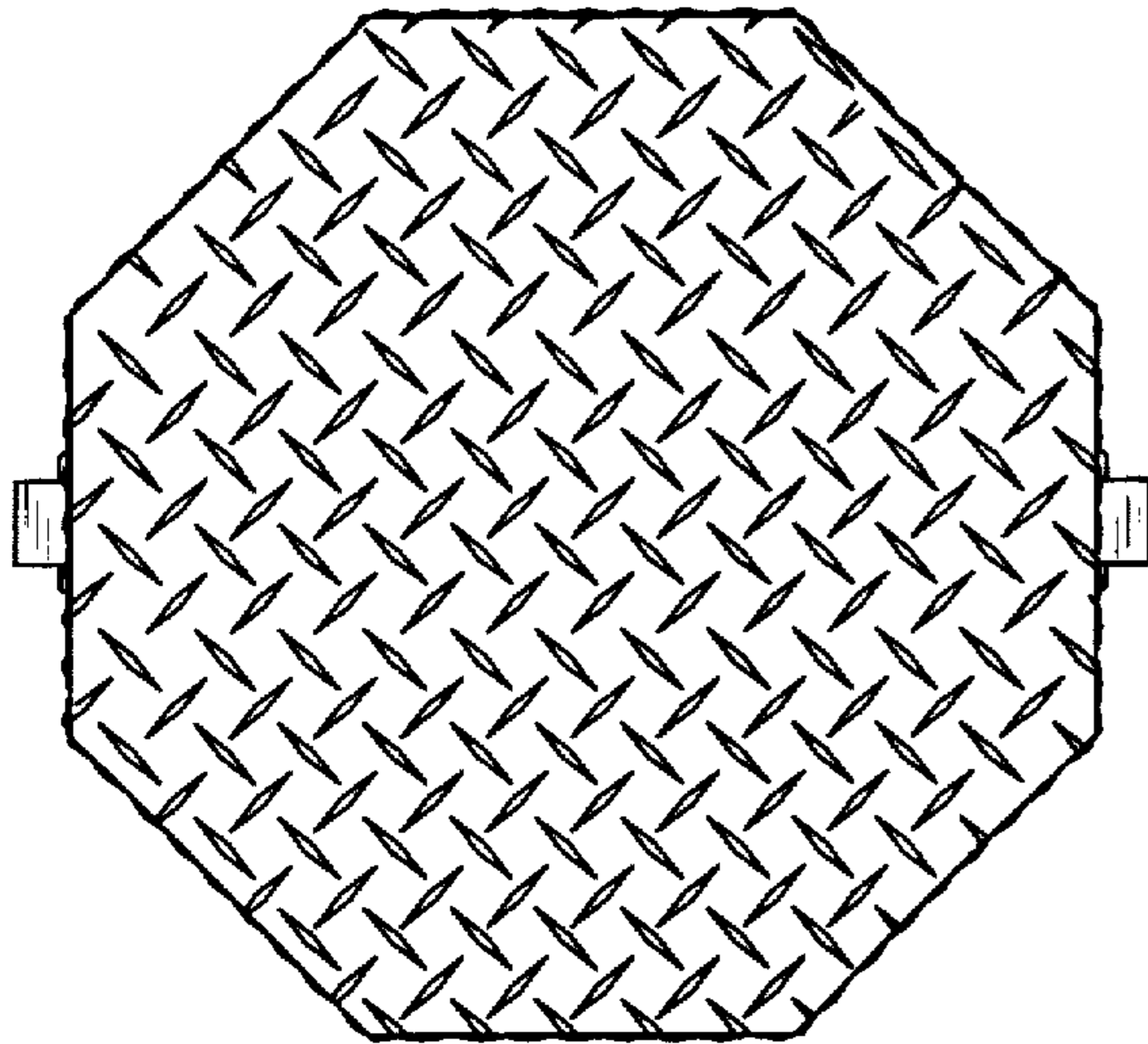

FIG. 6

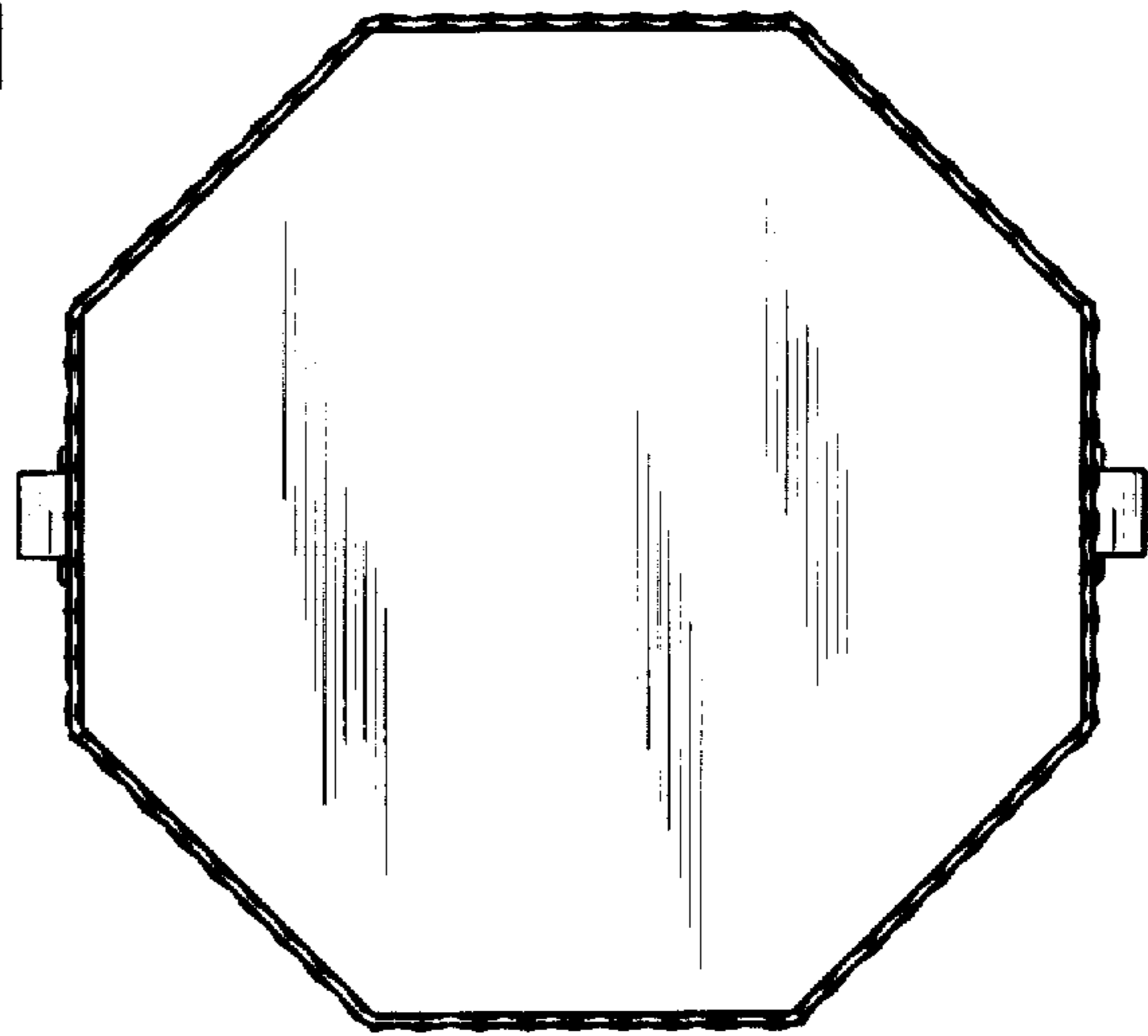

FIG. 7

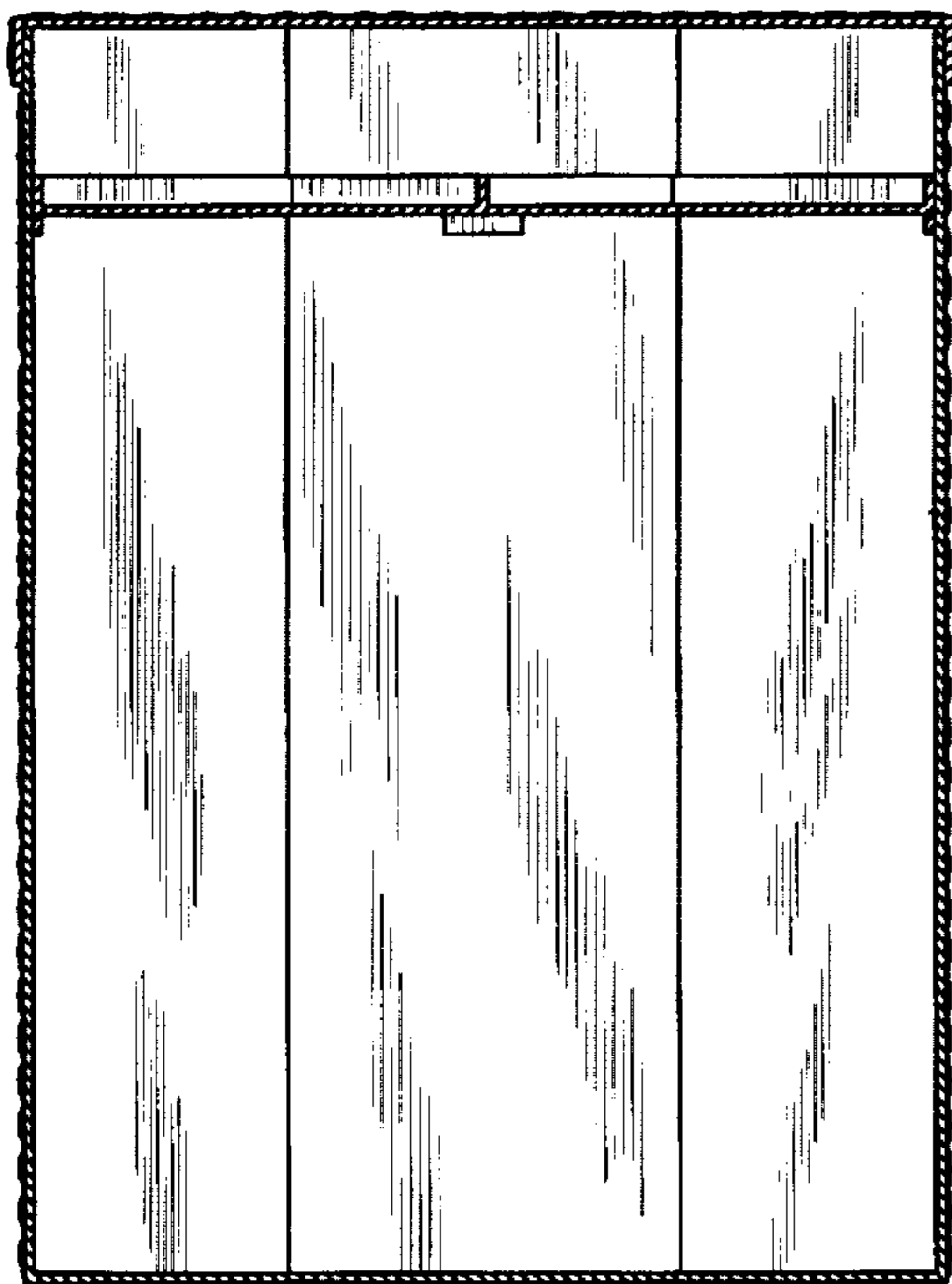

FIG. 8

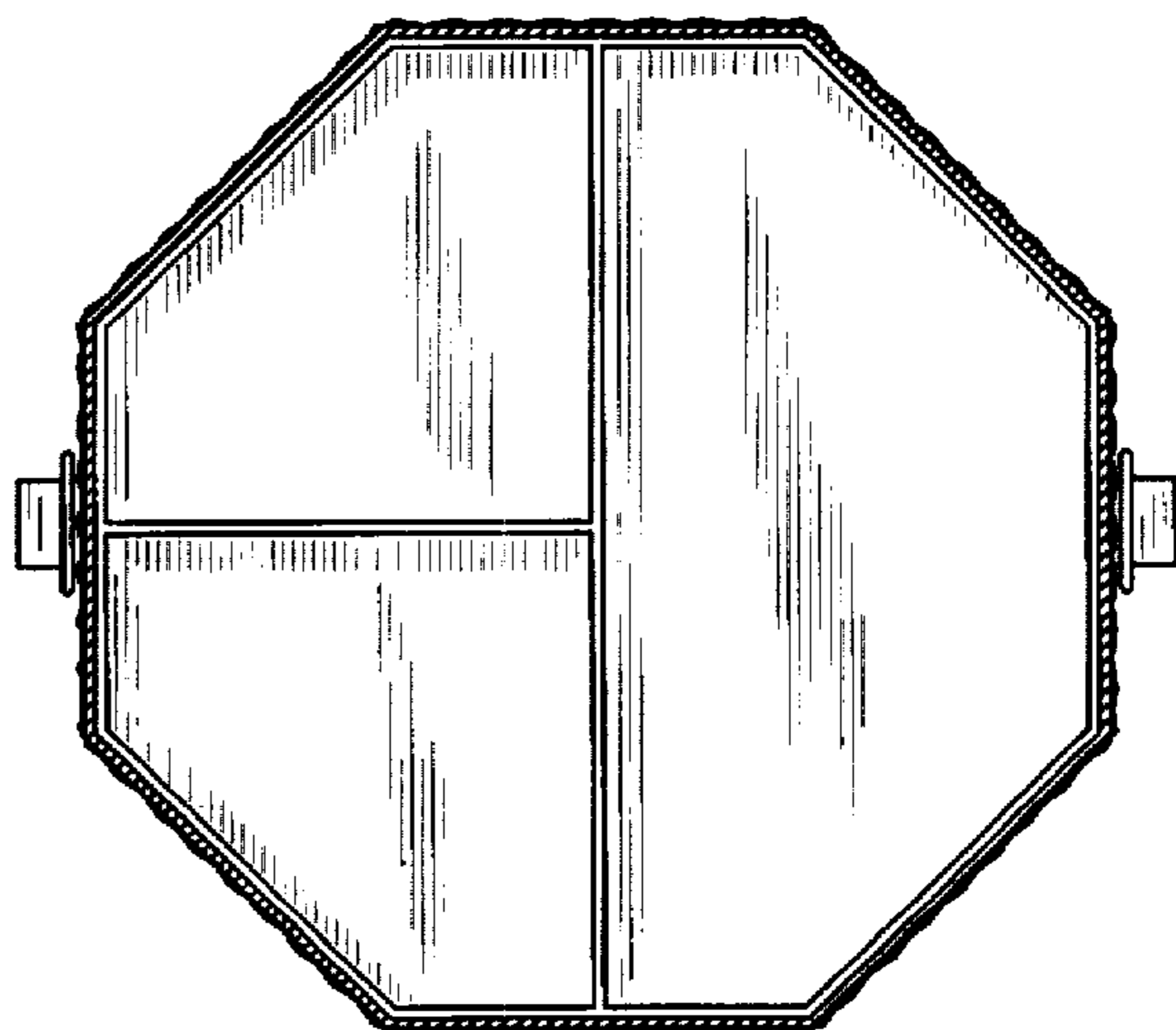

FIG. 9

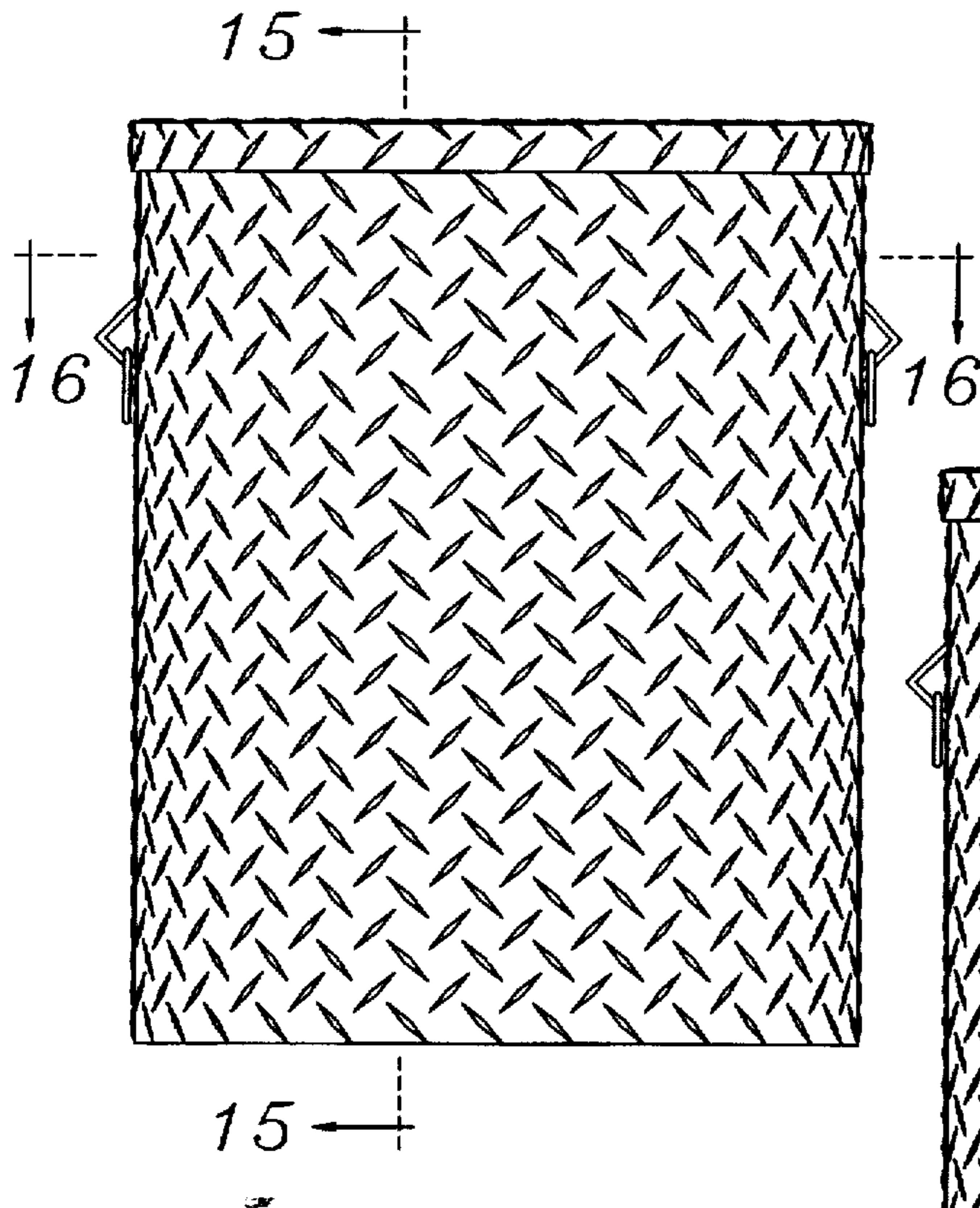

FIG. 10

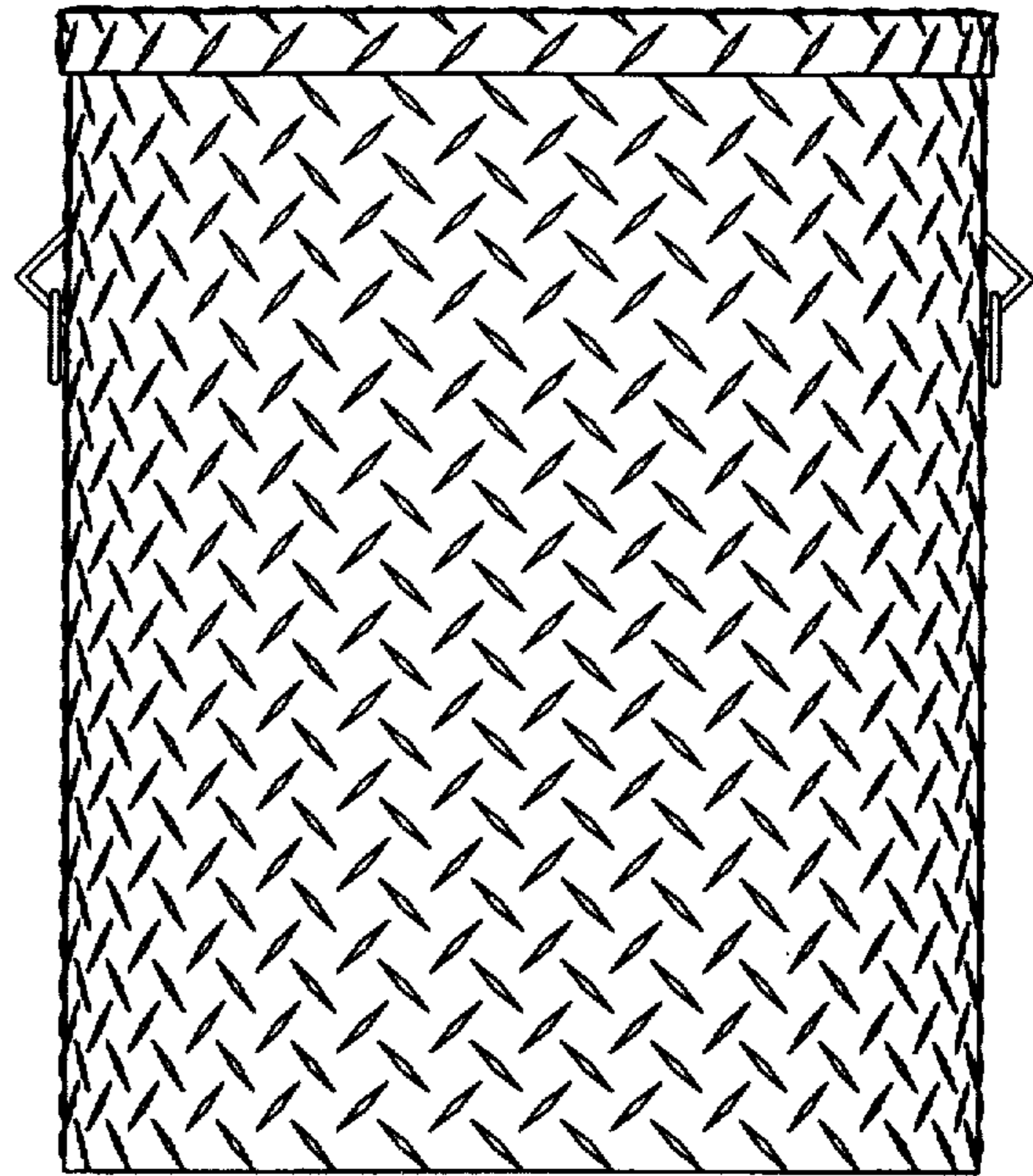

FIG. 11

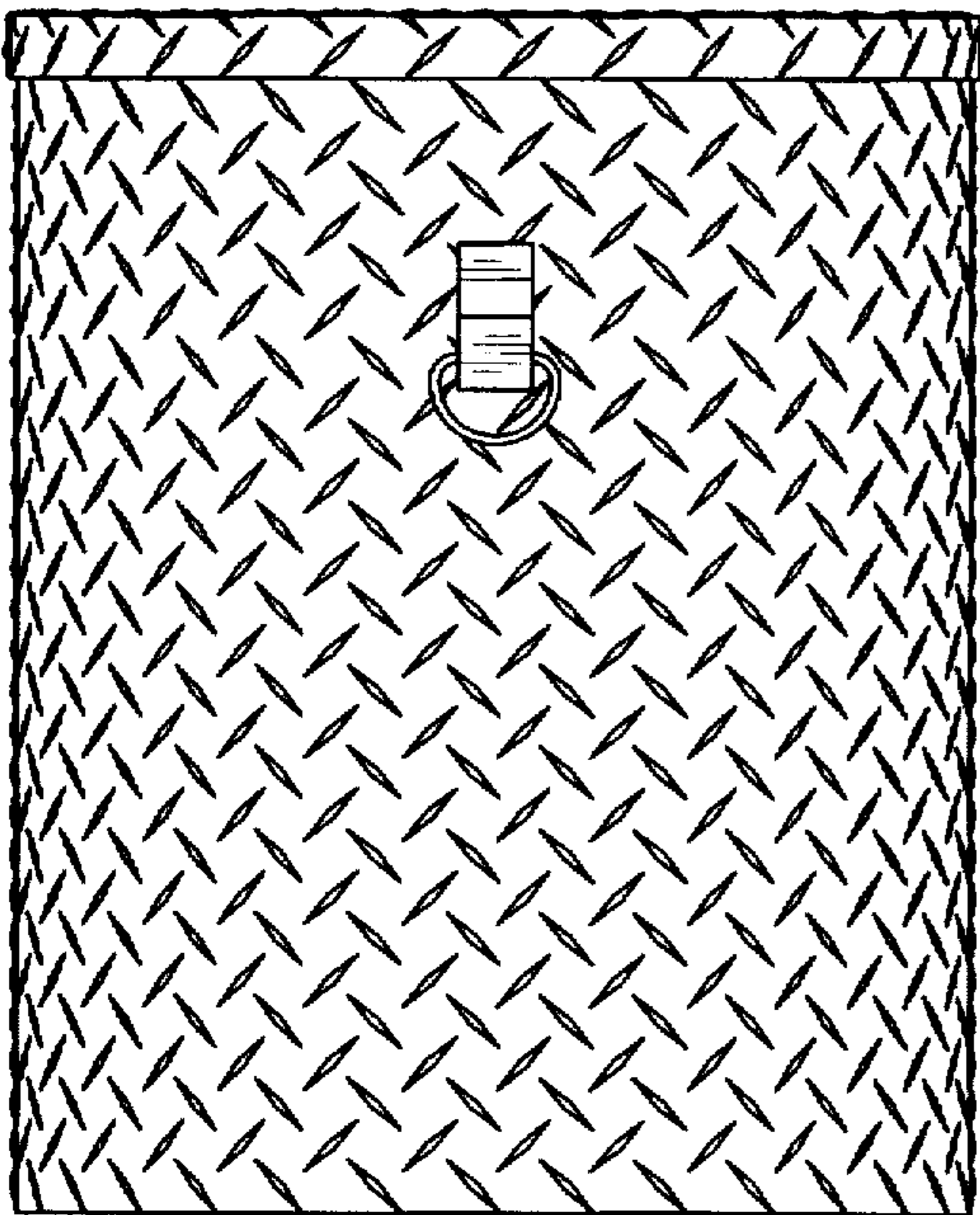

FIG. 12

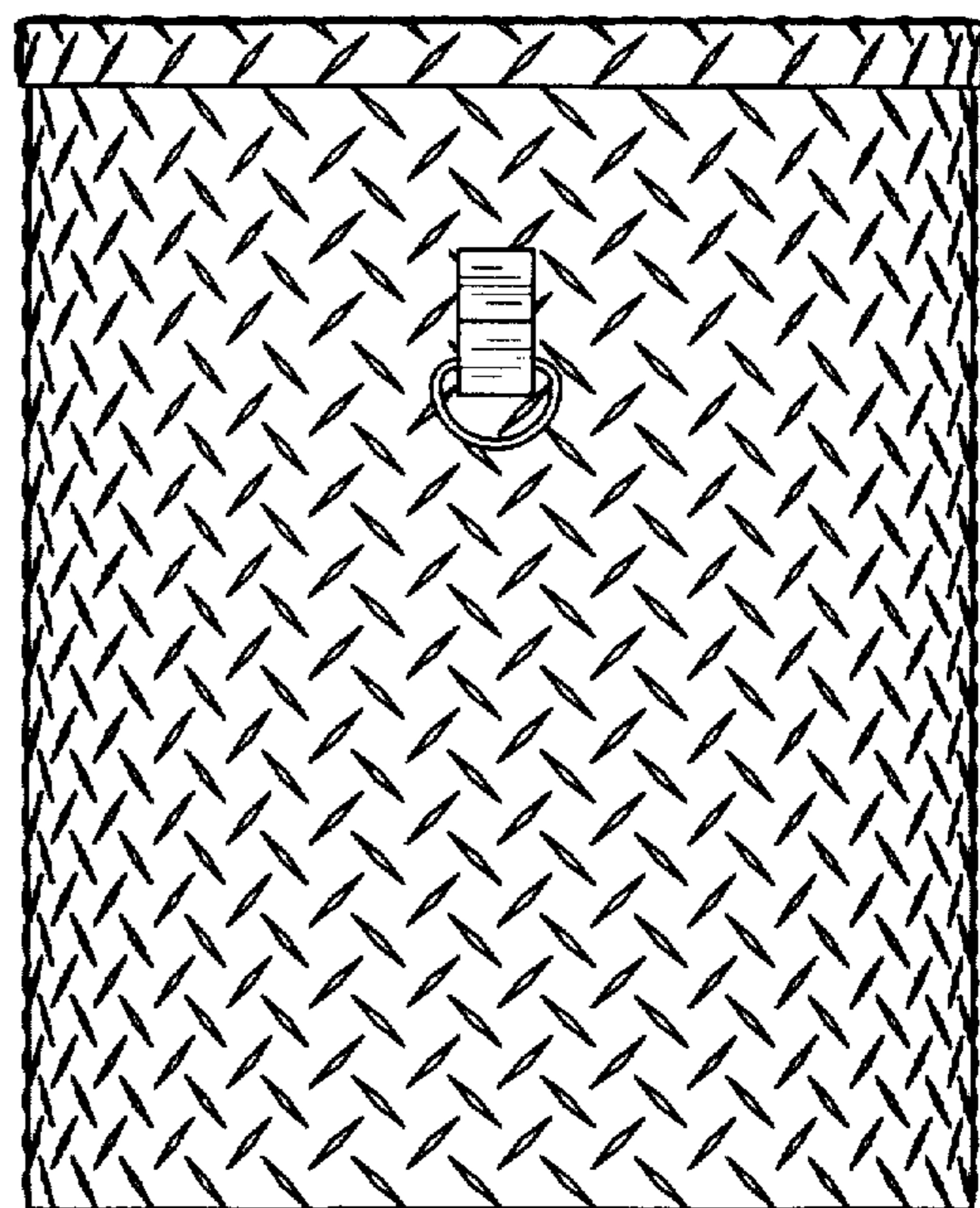

FIG. 13

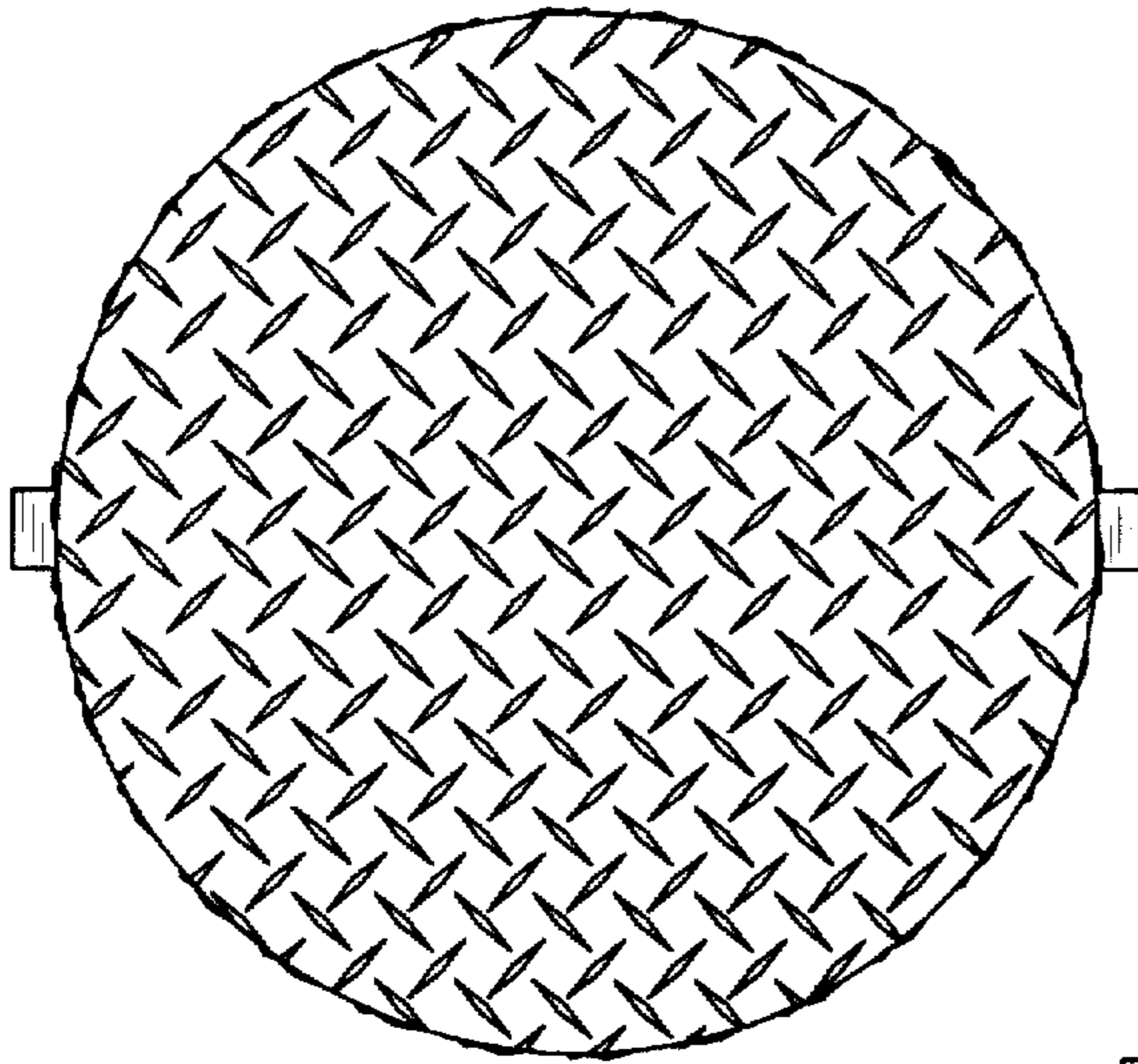

FIG. 14

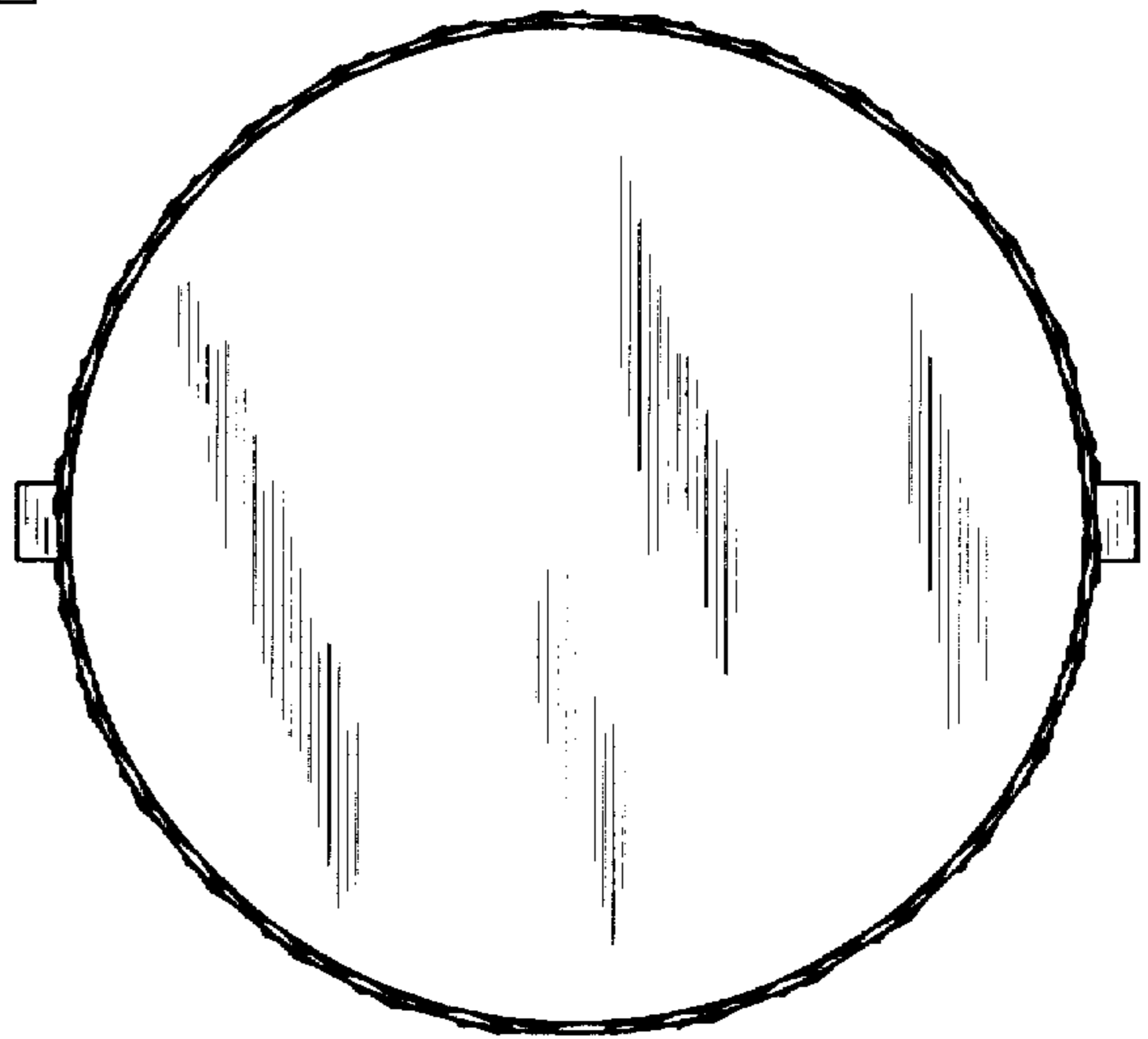

FIG. 15

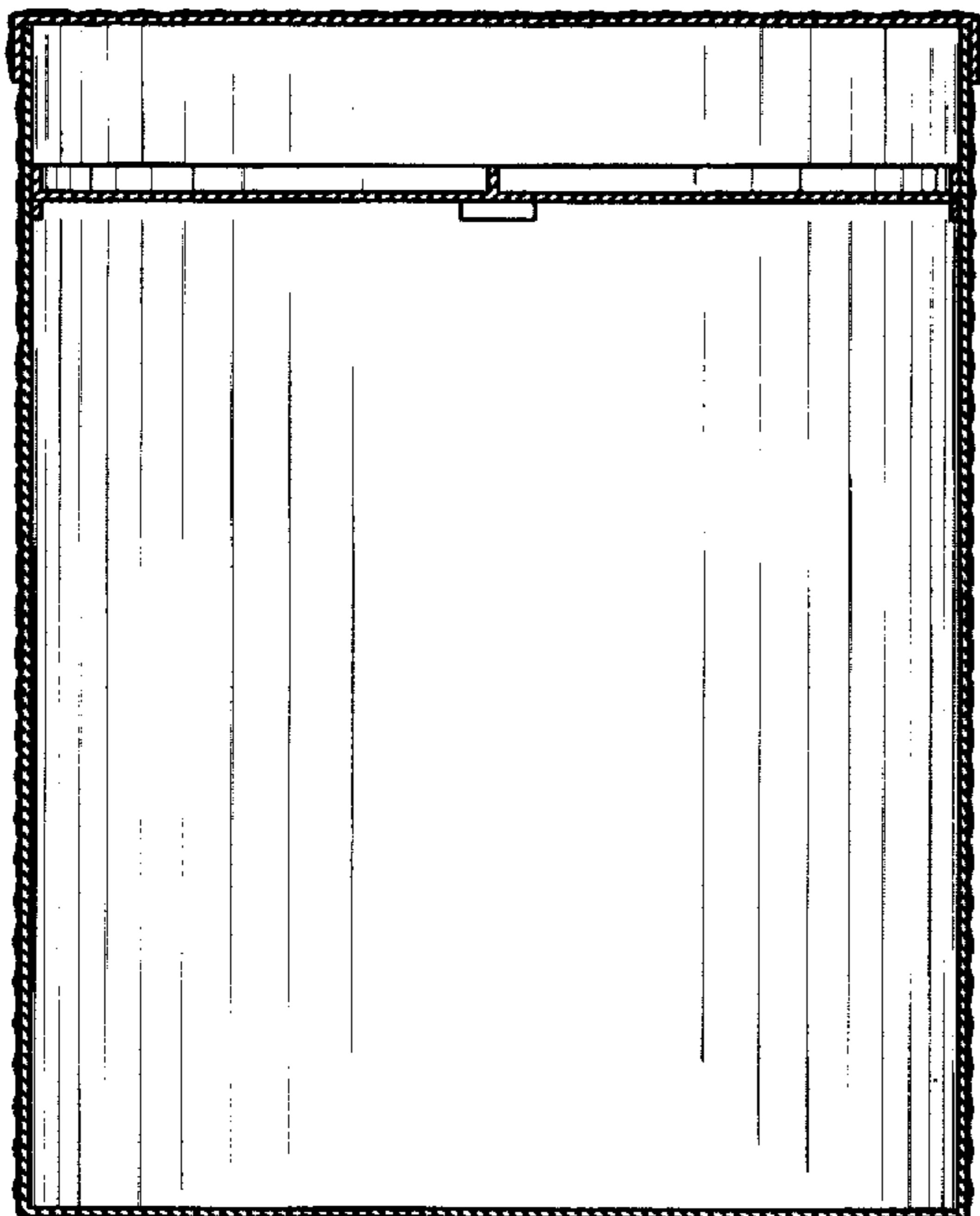

FIG. 16

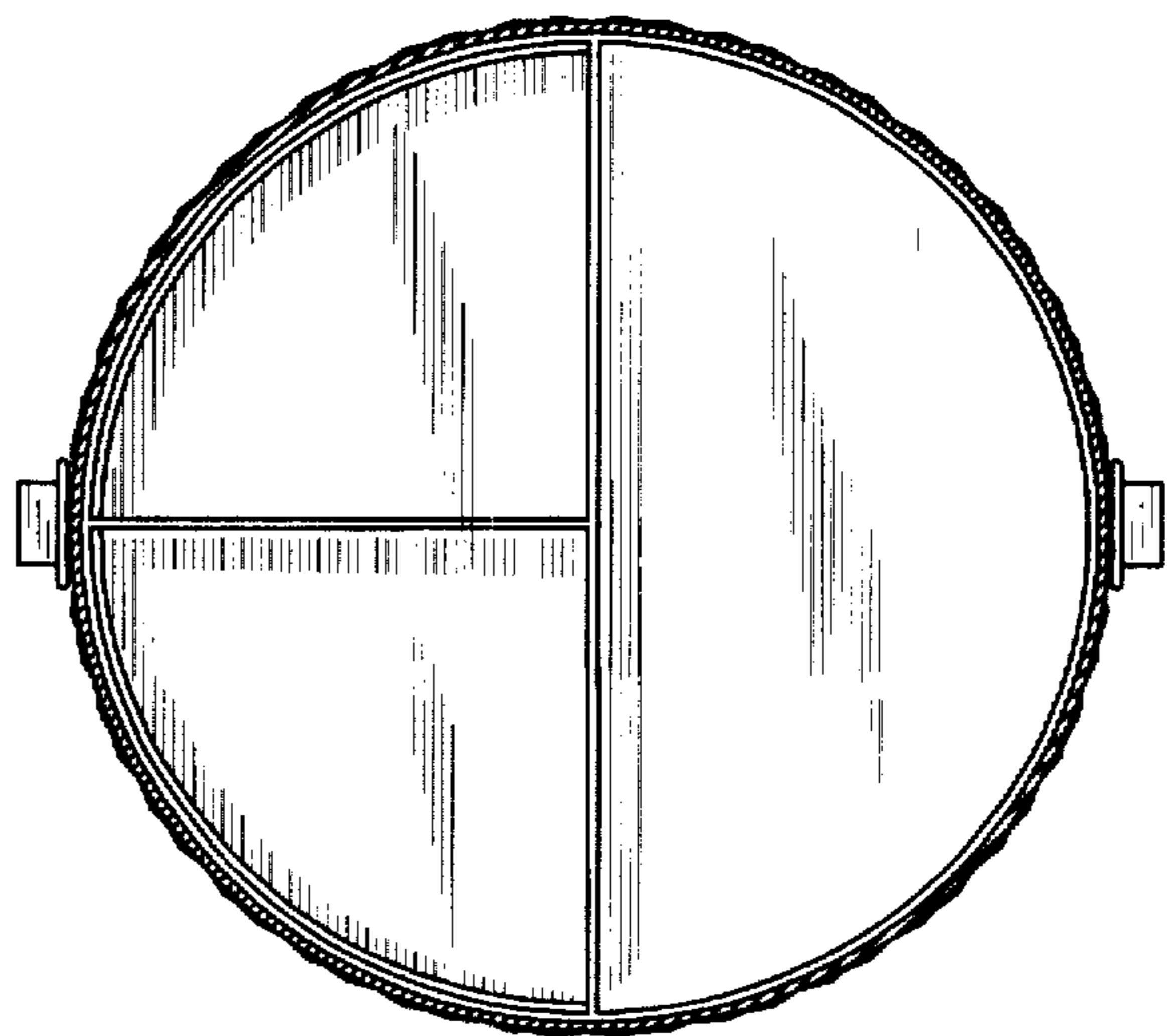

FIG. 17

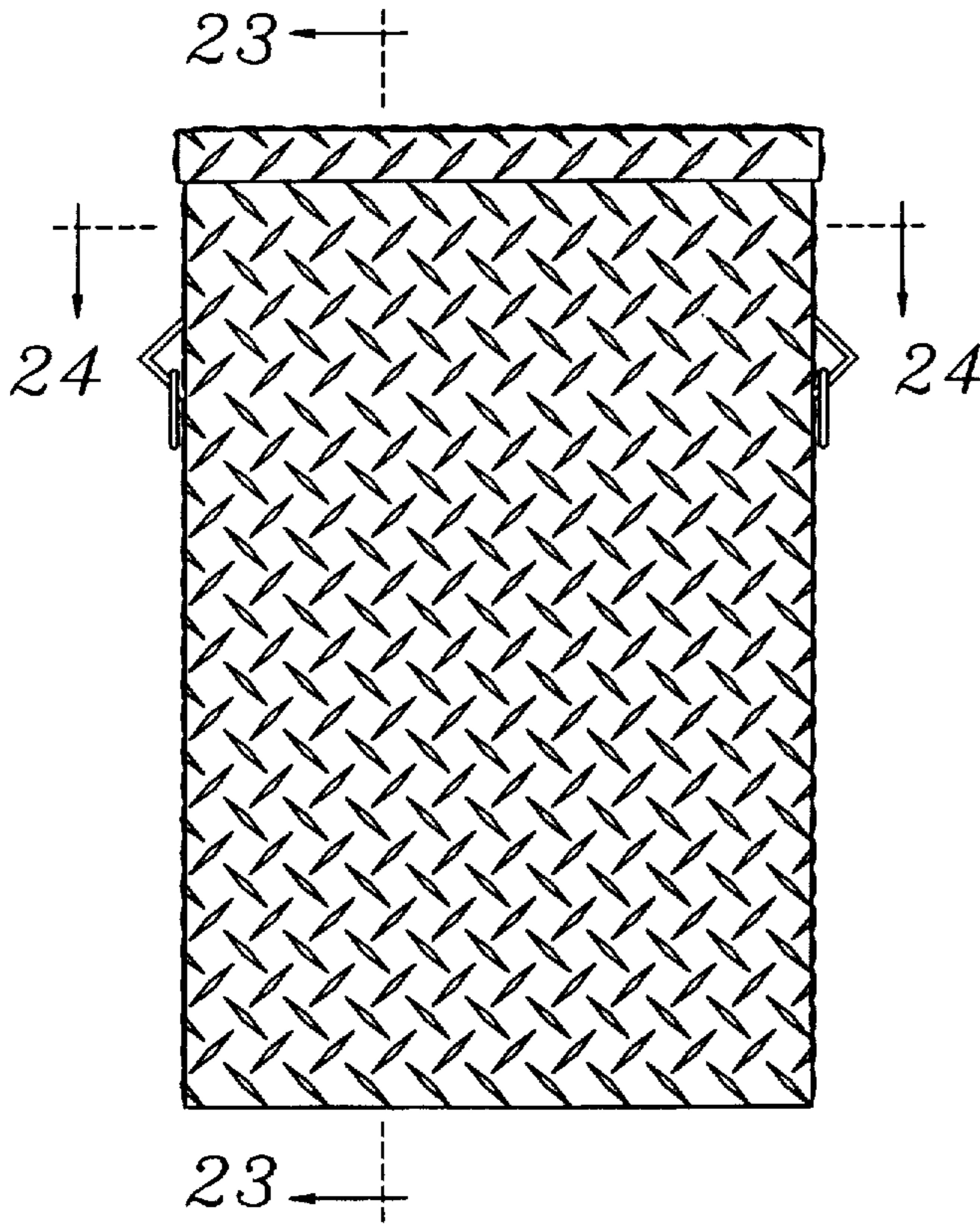

FIG. 18

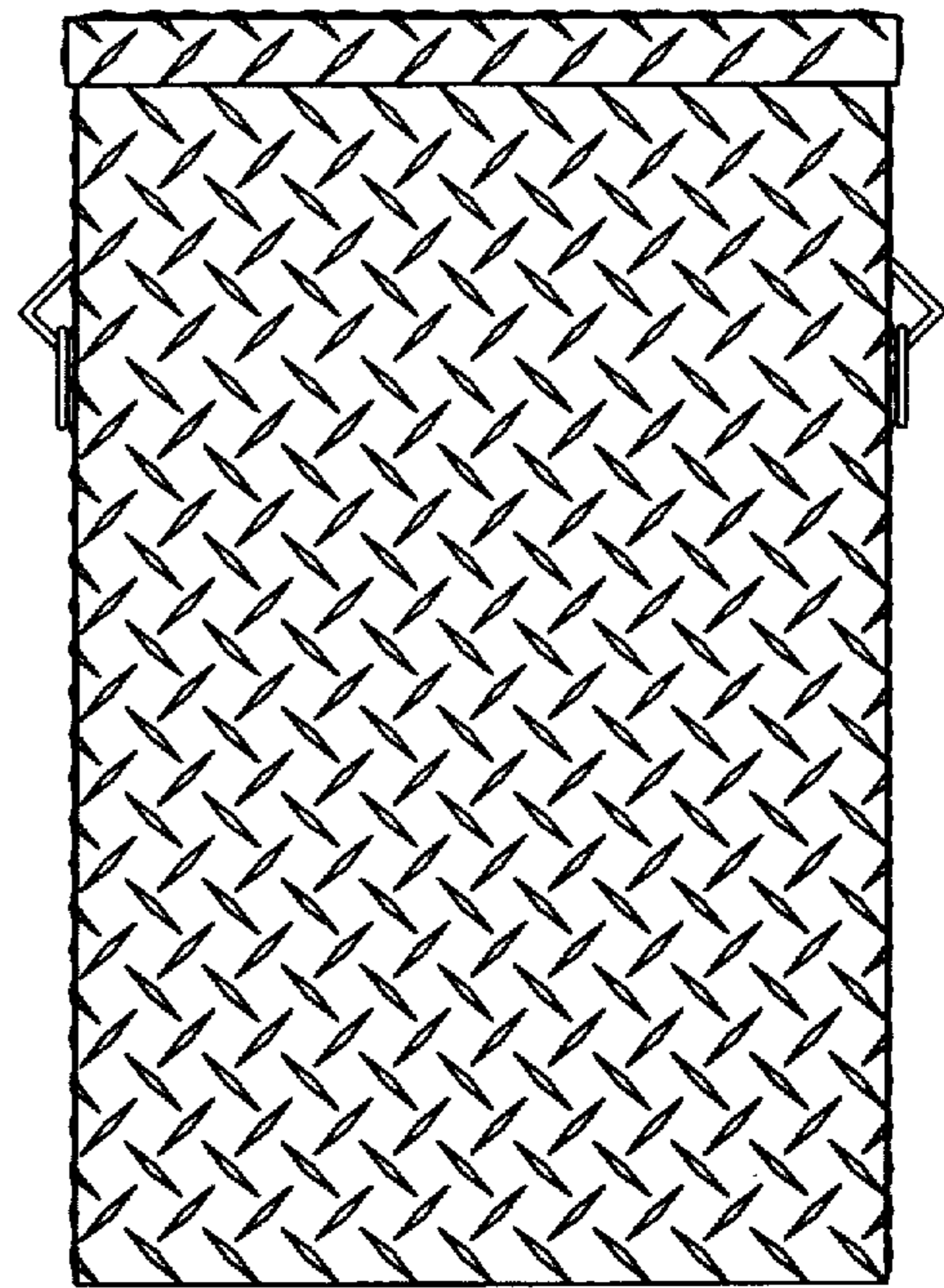

FIG. 19

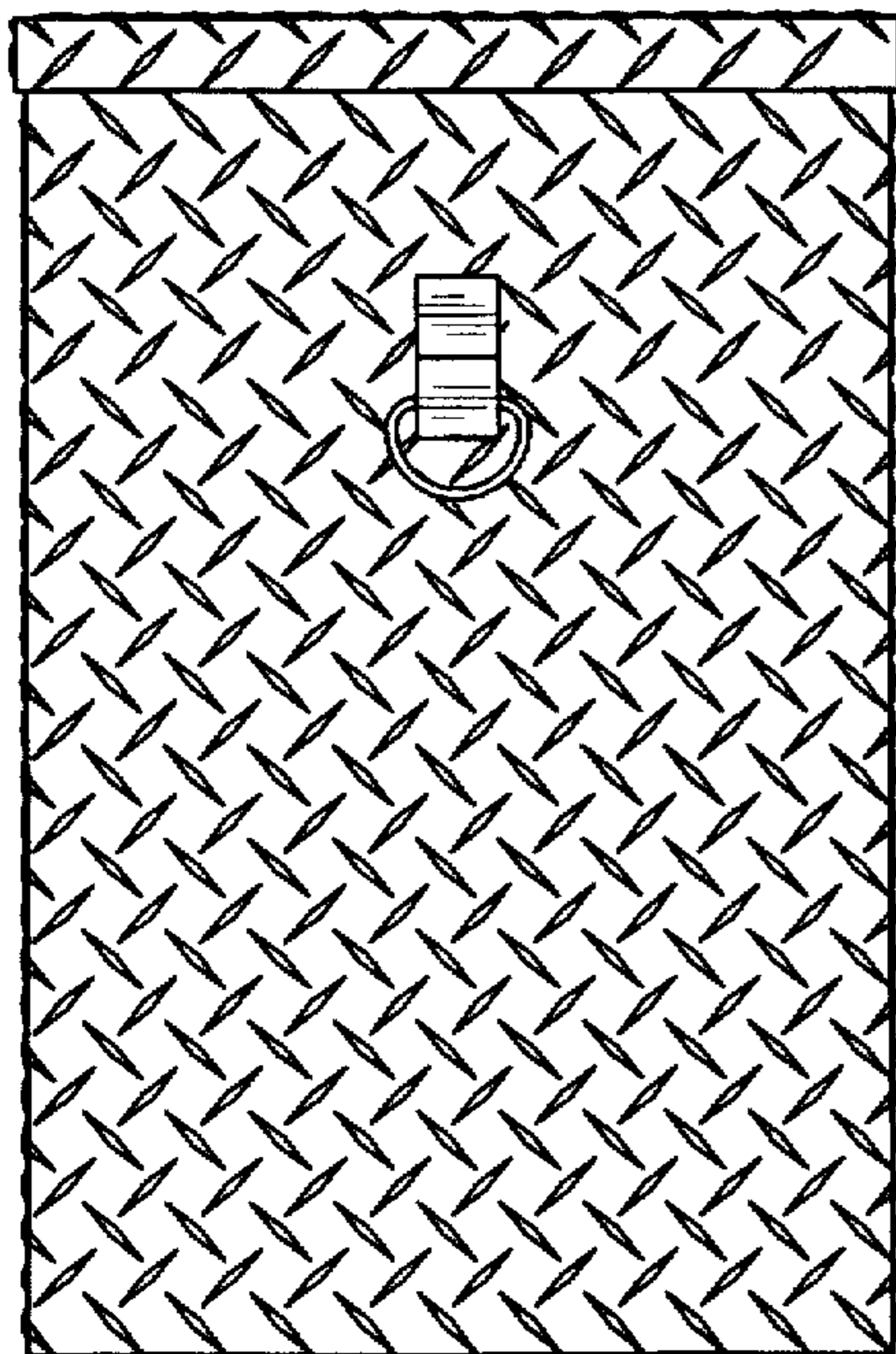

FIG. 20

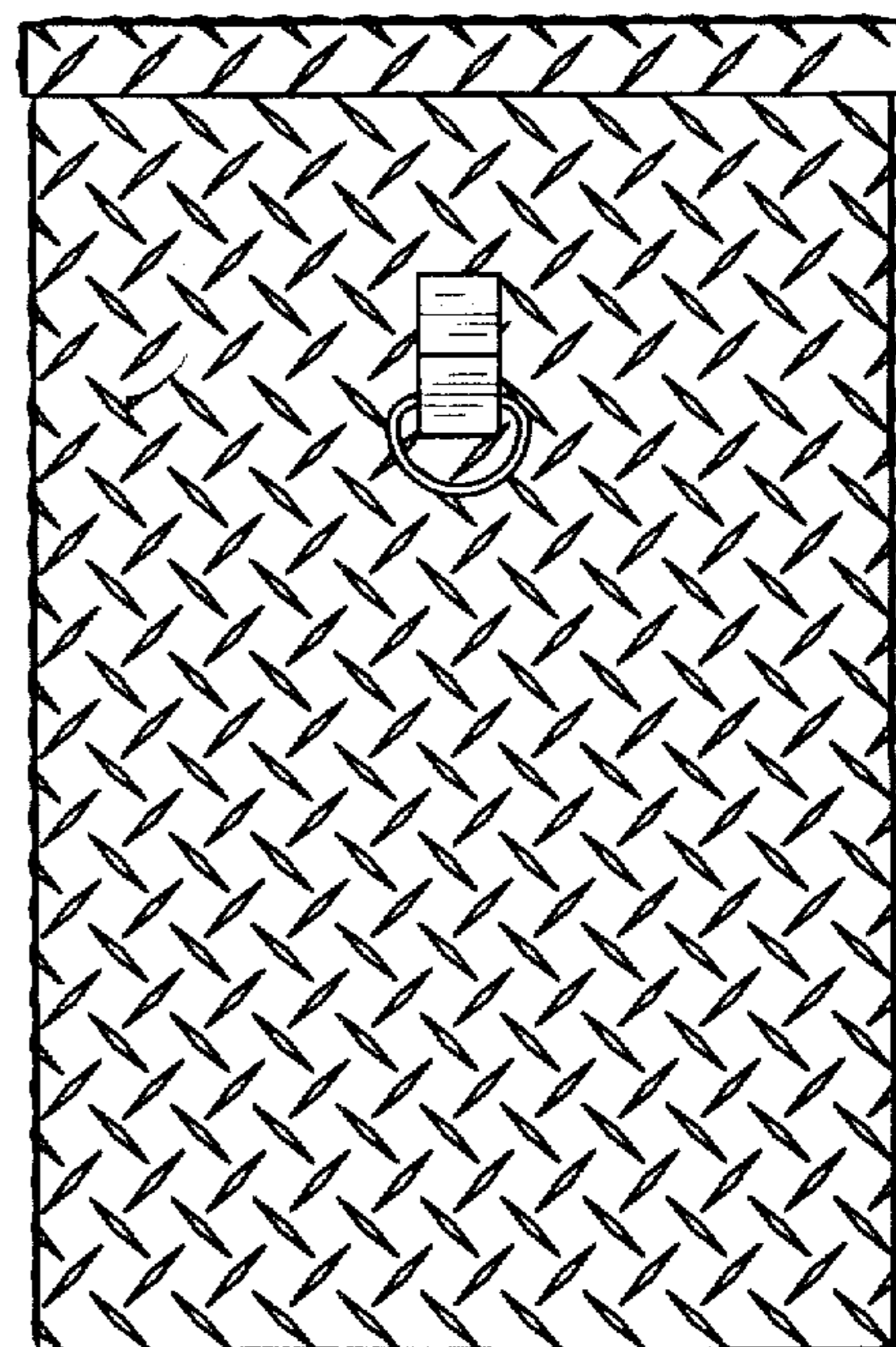

FIG. 21

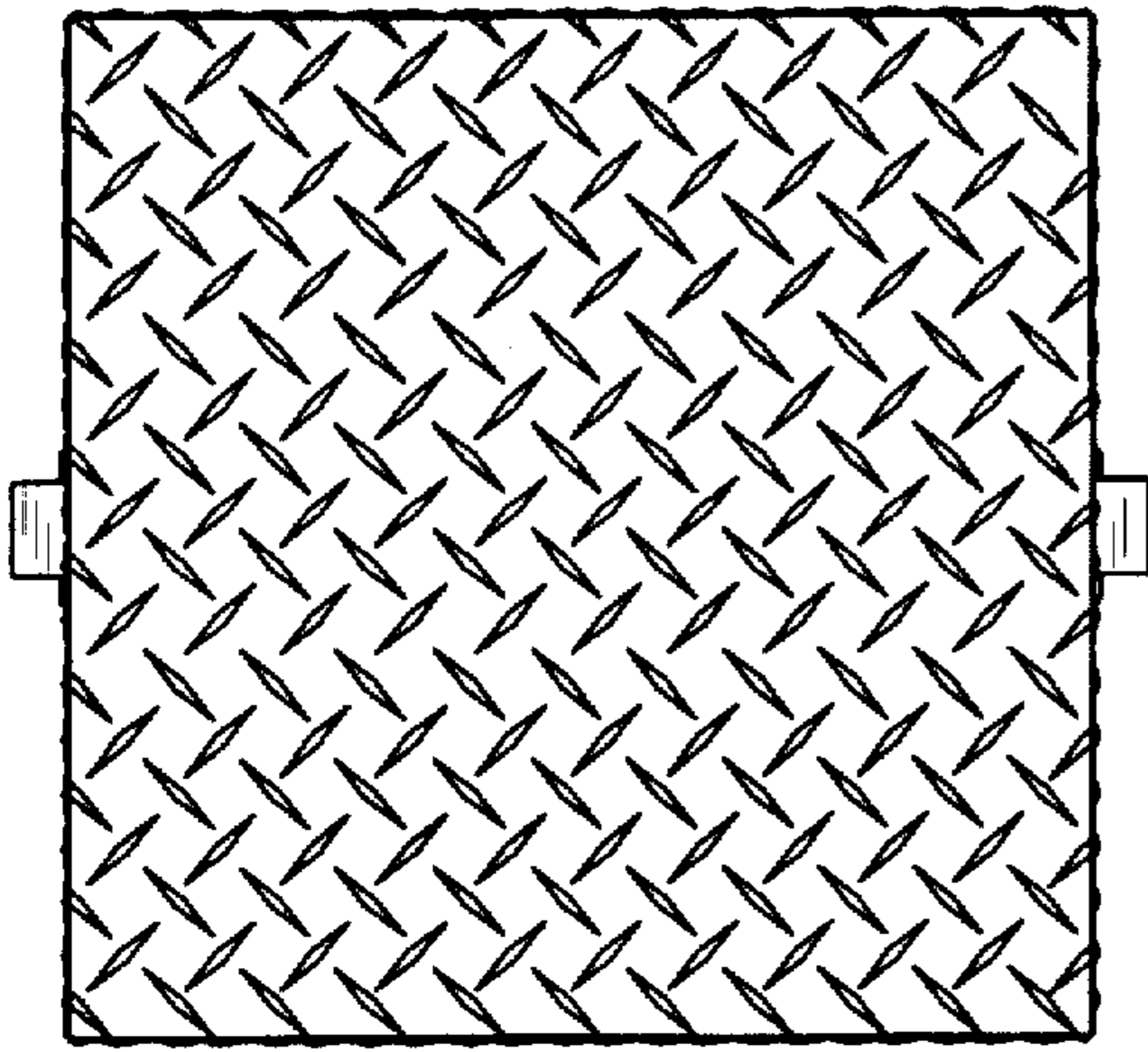

FIG. 22

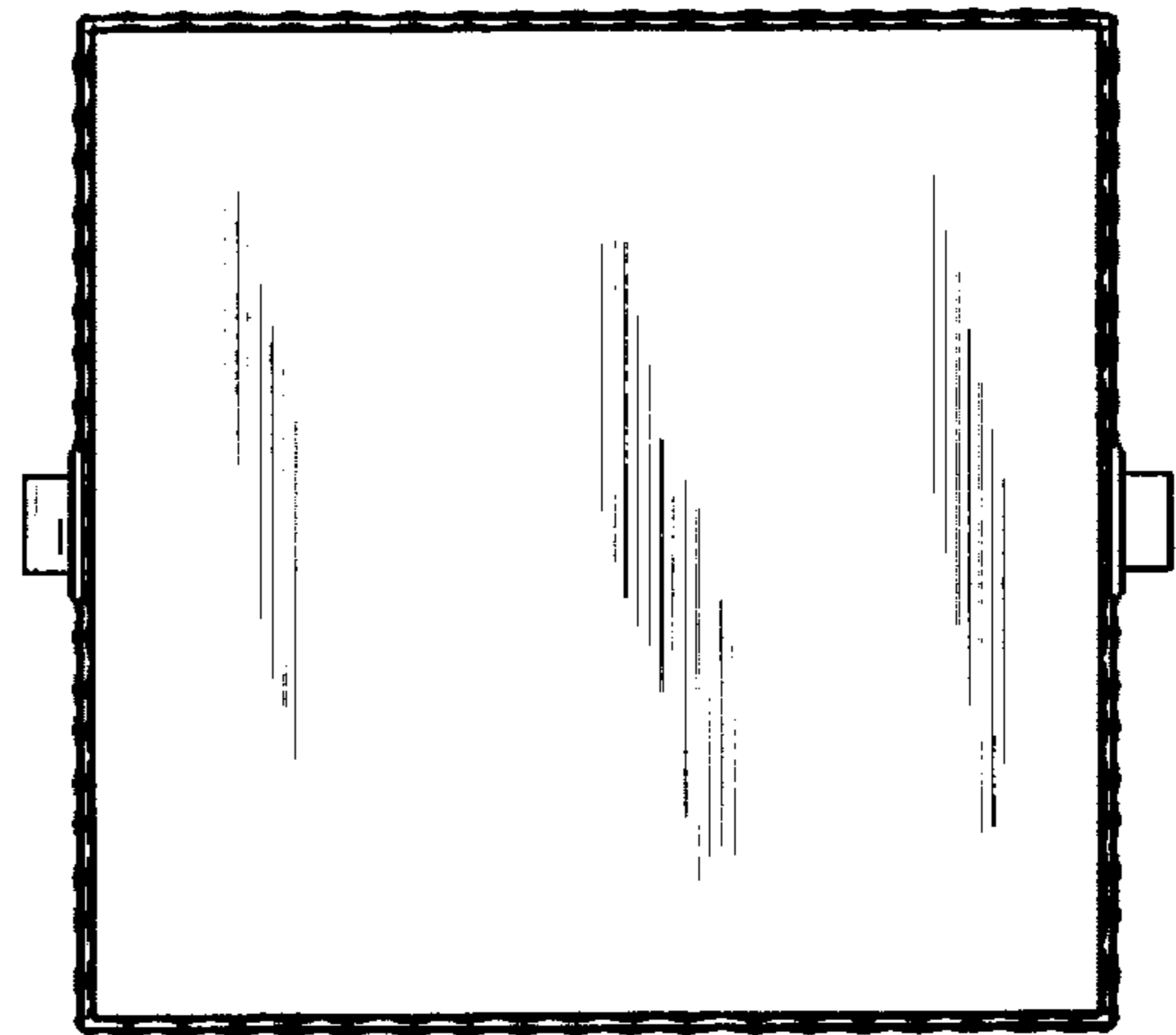

FIG. 23

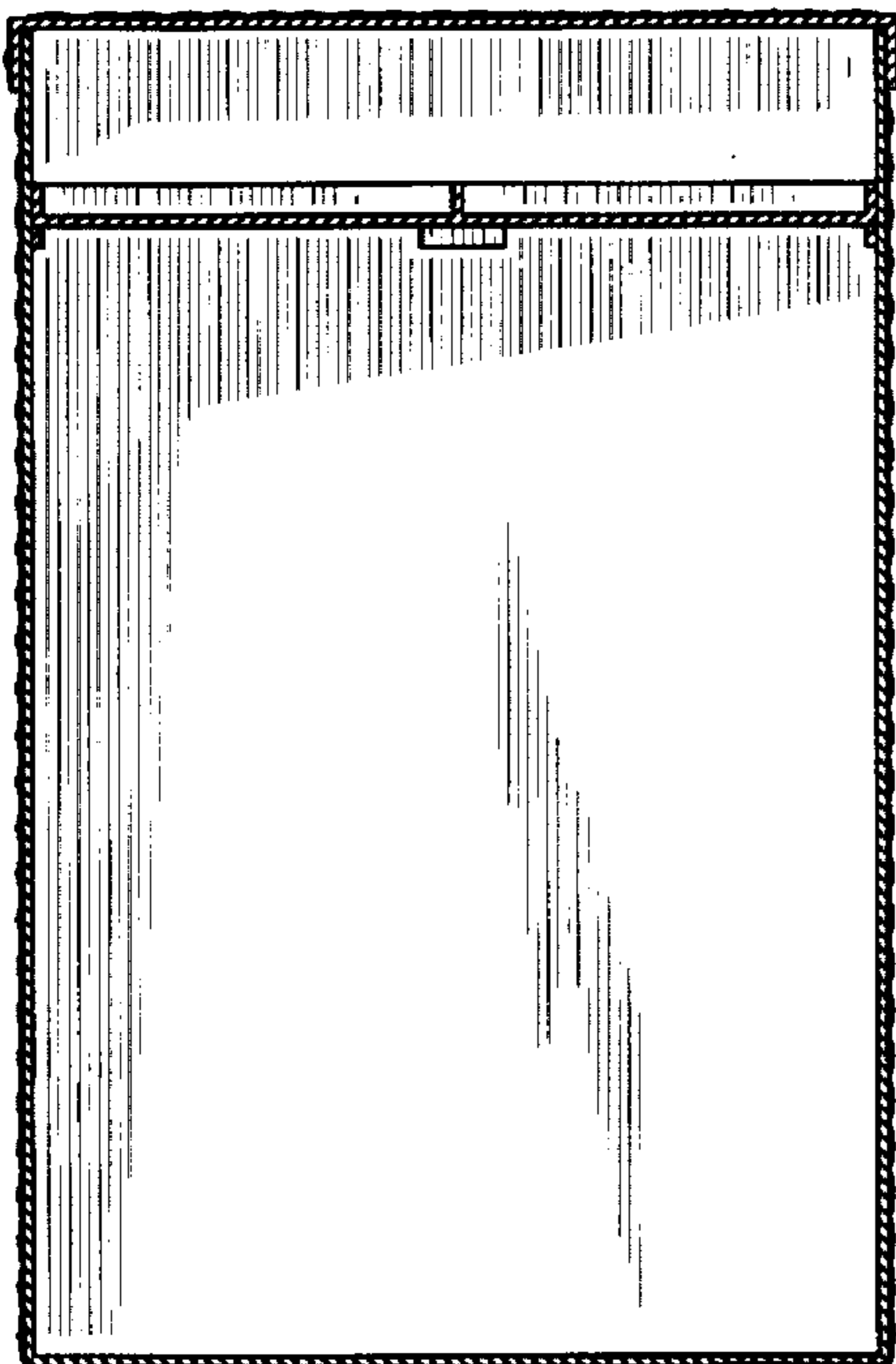

FIG. 24

