

US00D393924S

**United States Patent** [19]  
**Wright**

[11] **Patent Number: Des. 393,924**

[45] **Date of Patent: \*\*Apr. 28, 1998**

[54] **PACK FOR SMOKING ARTICLES**

339066 4/1936 Italy ..... 206/268

[75] **Inventor: Clive Graham Wright, Bristol, United Kingdom**

*Primary Examiner*—Holly Baynham  
*Attorney, Agent, or Firm*—Larson & Taylor

[73] **Assignee: Imperial Tobacco Limited, England**

[57] **CLAIM**

[\*\*] **Term: 14 Years**

The ornamental design of a package for smoking articles, as shown.

[21] **Appl. No.: 7,242**

**DESCRIPTION**

[22] **Filed: Apr. 19, 1993**

[30] **Foreign Application Priority Data**

Oct. 17, 1992 [GB] United Kingdom ..... 2026526  
Oct. 17, 1992 [GB] United Kingdom ..... 2026527

[51] **LOC (6) Cl. .... 27-06**

[52] **U.S. Cl. .... D27/189**

[58] **Field of Search** ..... D27/186, 189-190;  
D9/420, 432, 423; 206/259, 261, 265, 266,  
268, 271, 273

FIG. 1 is a front elevational view of a package for smoking articles showing my new design;  
FIG. 2 is a top plan view thereof;  
FIG. 3 is a bottom plan view thereof;  
FIG. 4 is a right side elevational view thereof;  
FIG. 5 is a left side elevational view thereof;  
FIG. 6 is a rear elevational view thereof;  
FIG. 7 is a front right hand perspective view thereof;  
FIG. 8 is a rear, left perspective view thereof;  
FIG. 9 is a perspective view similar to FIG. 7, but showing the package in an opened condition;  
FIG. 10 is a perspective view similar to FIG. 8, but showing the package in an opened condition;  
FIG. 11 is a front elevational view of a second embodiment of the new design shown in FIG. 1;  
FIG. 12 is a top plan view thereof;  
FIG. 13 is a bottom plan view thereof;  
FIG. 14 is a right side elevational view thereof;  
FIG. 15 is a left side elevational view thereof;  
FIG. 16 is a rear elevational view thereof;  
FIG. 17 is a front right hand perspective view thereof;  
FIG. 18 is a rear left side perspective view thereof;  
FIG. 19 is a perspective view similar to FIG. 17, but showing the package in an opened condition; and  
FIG. 20 is a perspective view similar to FIG. 18, but showing the package in an opened condition.  
The broken line showing of cigar and wrappings therefor are for illustrative purposes only and form no part of the claimed design.

[56] **References Cited**

**U.S. PATENT DOCUMENTS**

D. 136,319 9/1943 New ..... D27/191  
D. 303,722 9/1989 Marlow et al. .... D27/189  
1,735,323 11/1929 L'Enfant ..... 206/251  
1,735,325 11/1929 L'Enfant ..... 206/265 X  
1,877,955 9/1932 Ottinger ..... 206/273 X  
2,824,684 2/1958 Ahlers ..... 206/268 X  
2,897,958 8/1959 Tarleton et al. .... 206/266 X  
2,958,418 11/1960 O'Gorman ..... 206/268  
2,992,766 7/1961 Guyer ..... 206/268 X  
3,472,362 10/1969 Shinoda ..... 206/266 X  
3,823,865 7/1974 Mechnick ..... 206/268 X  
4,447,003 5/1984 Gray ..... 206/268 X  
5,097,948 3/1992 Campbell ..... 206/268  
5,158,664 10/1992 Colgan et al. .... 206/268 X

**FOREIGN PATENT DOCUMENTS**

723301 9/1931 France ..... 206/268  
1632615 10/1969 Germany ..... 431/131

**1 Claim, 10 Drawing Sheets**

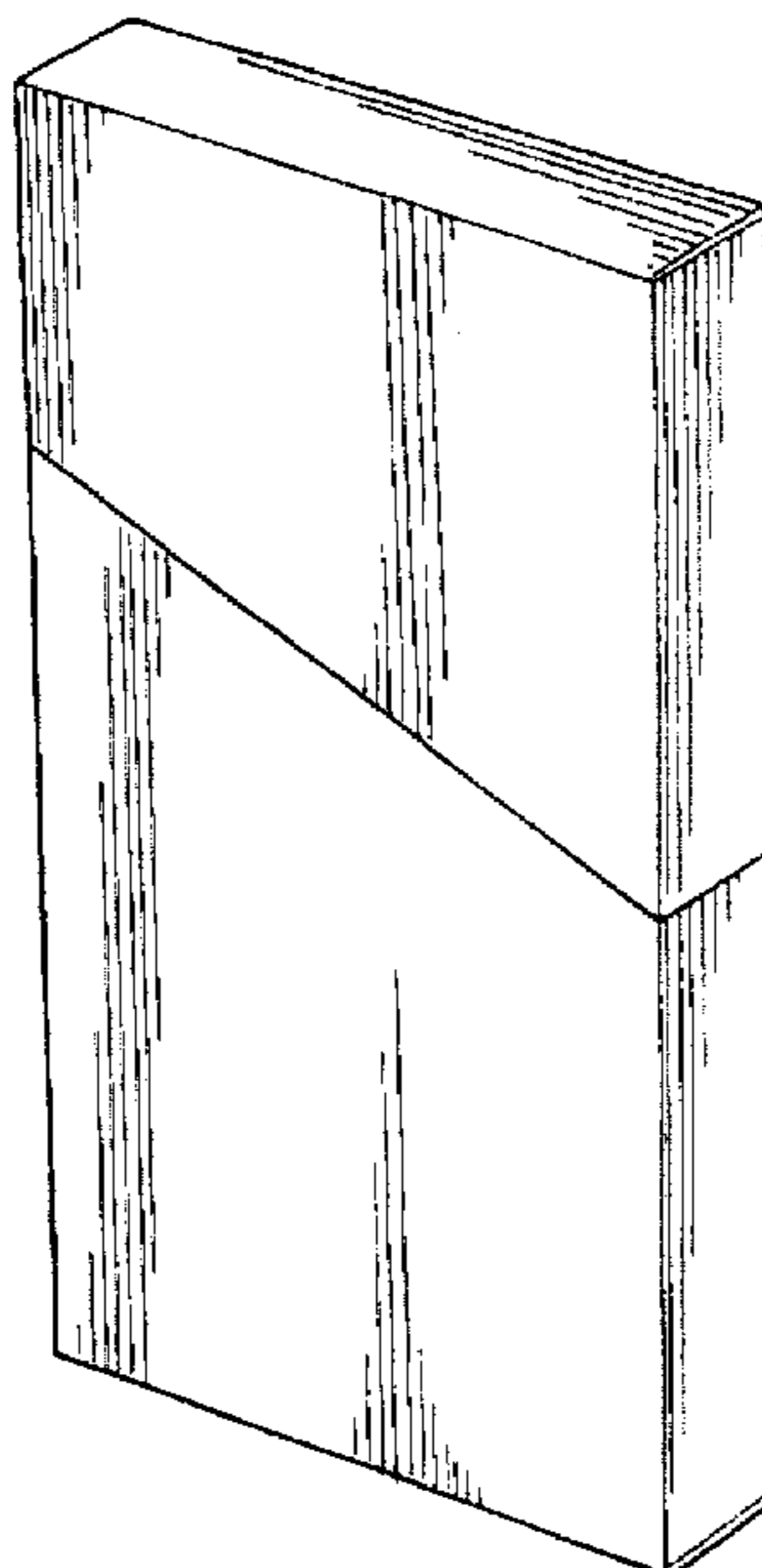

FIG. 3

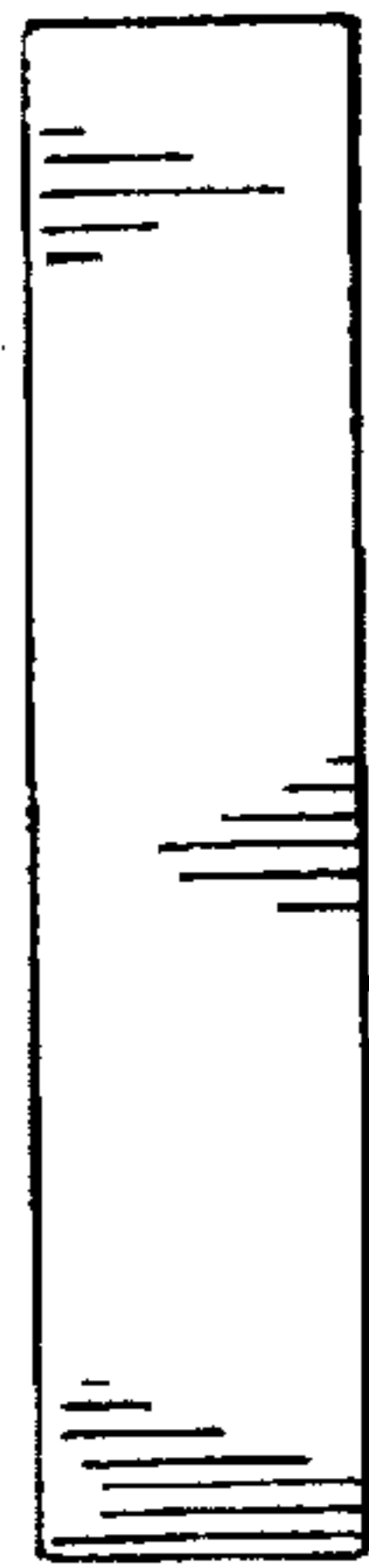
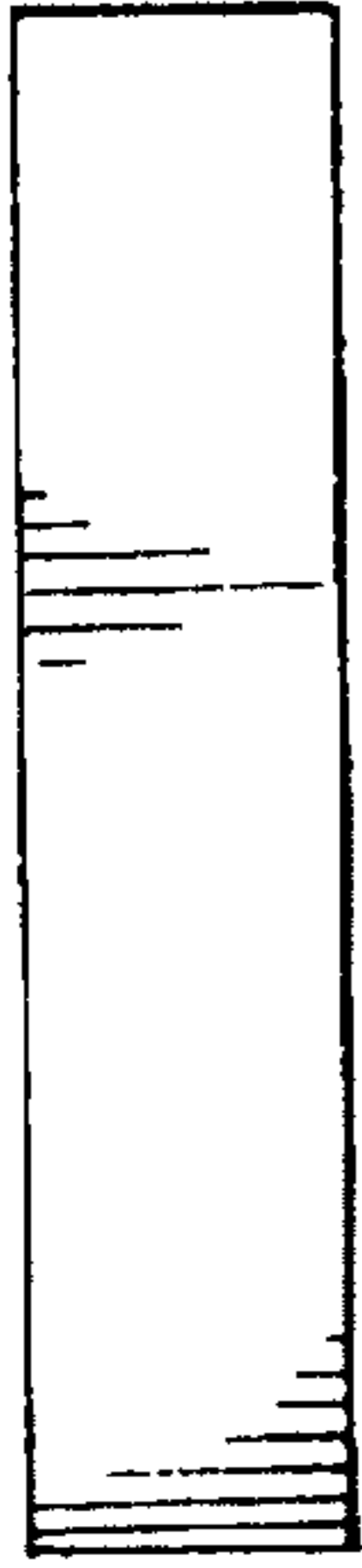

FIG. 2

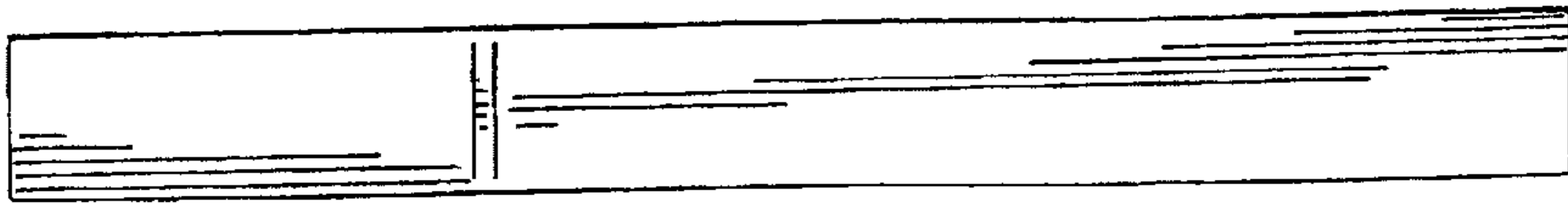
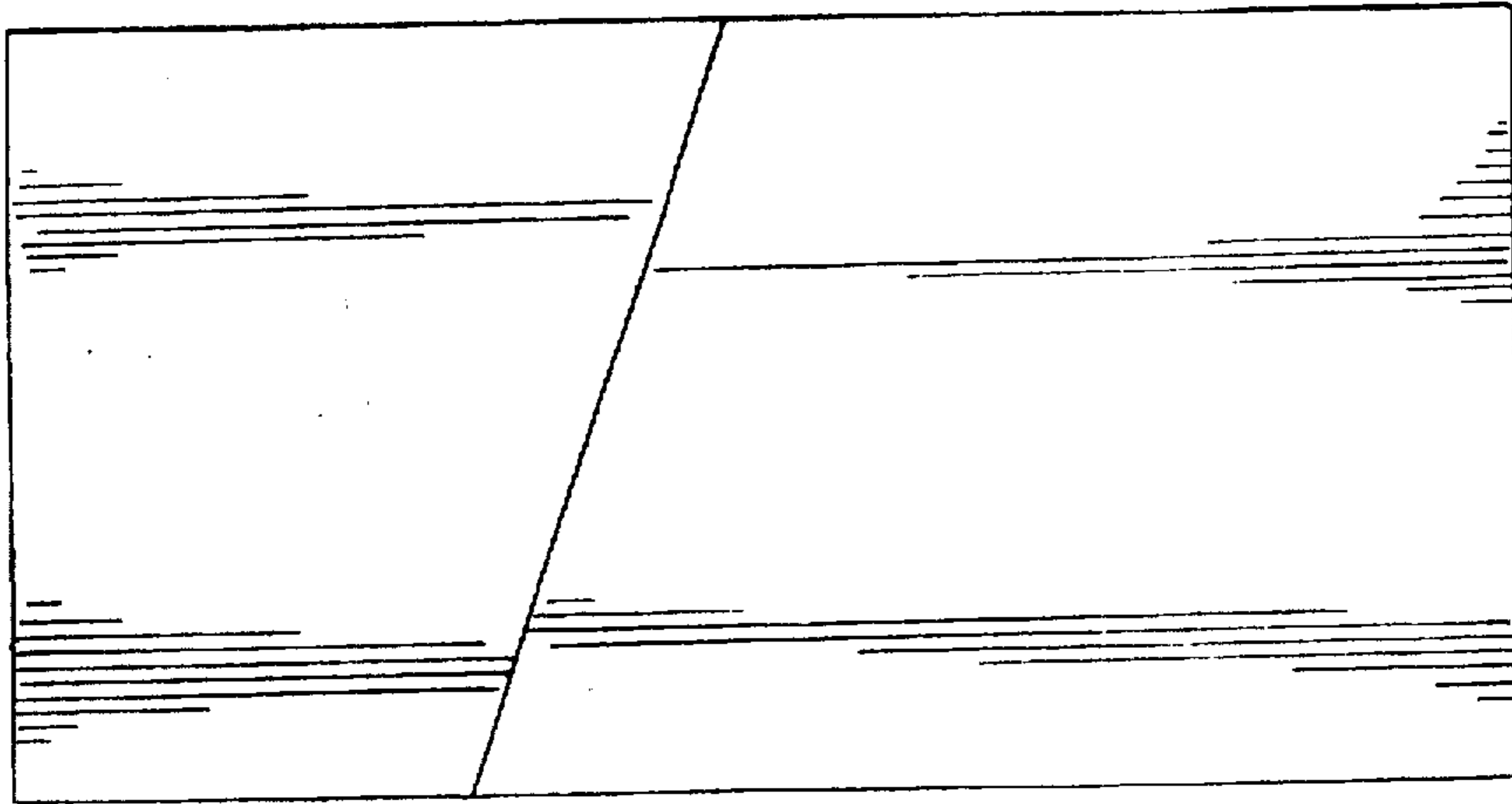
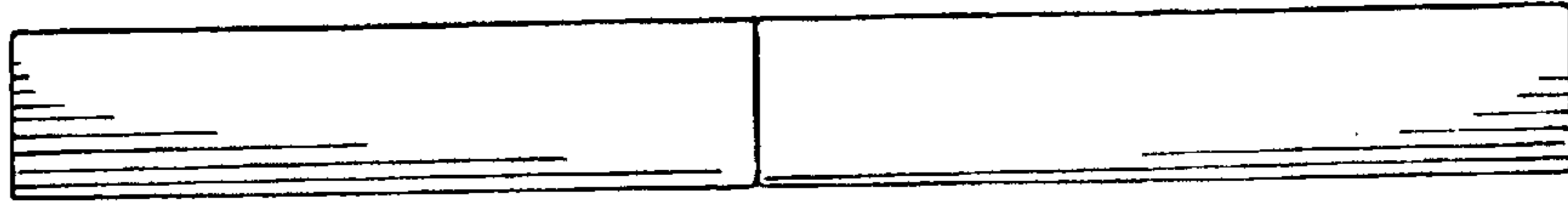
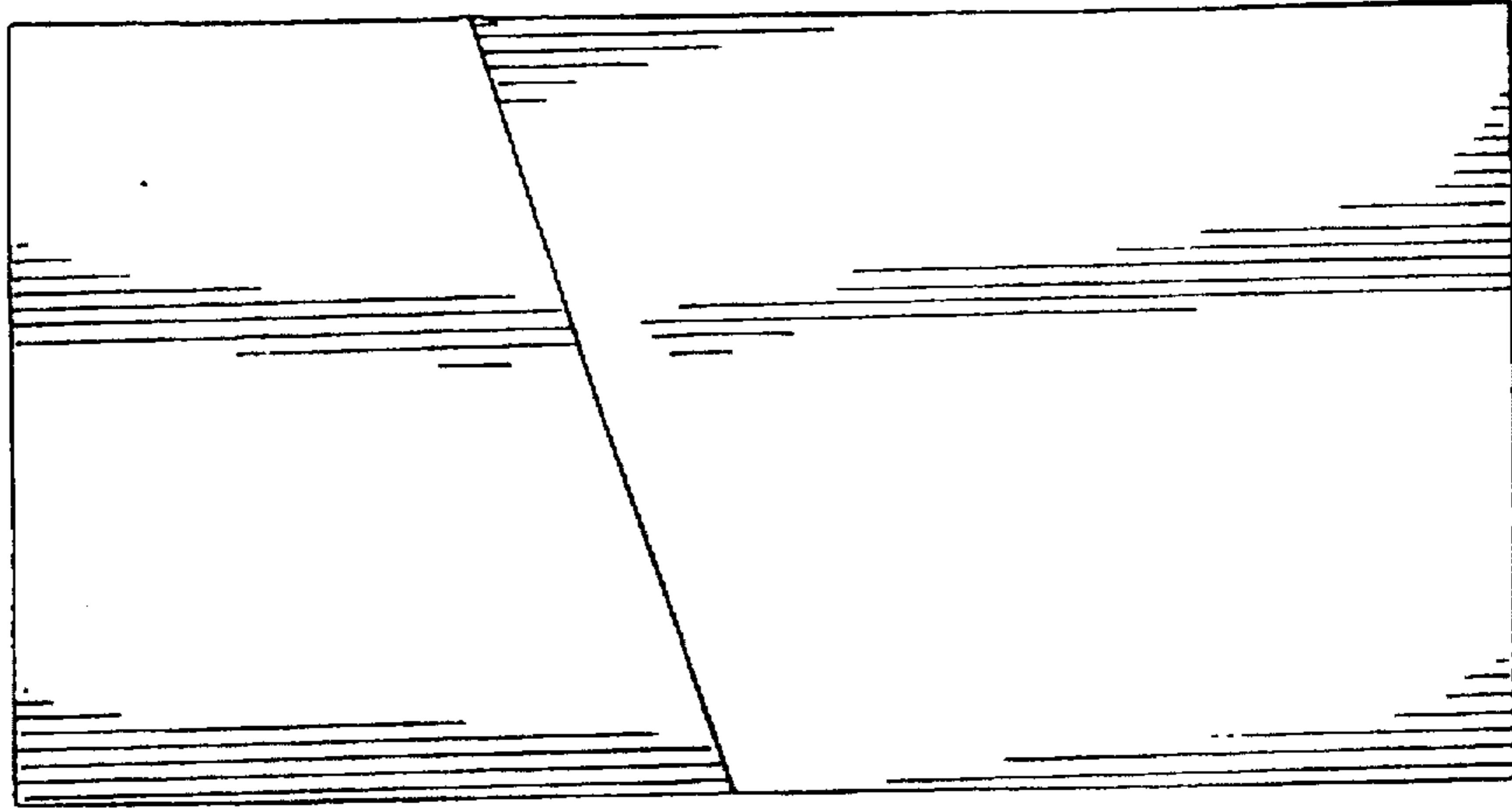

FIG. 6

FIG. 4

FIG. 1

FIG. 5

FIG. 7

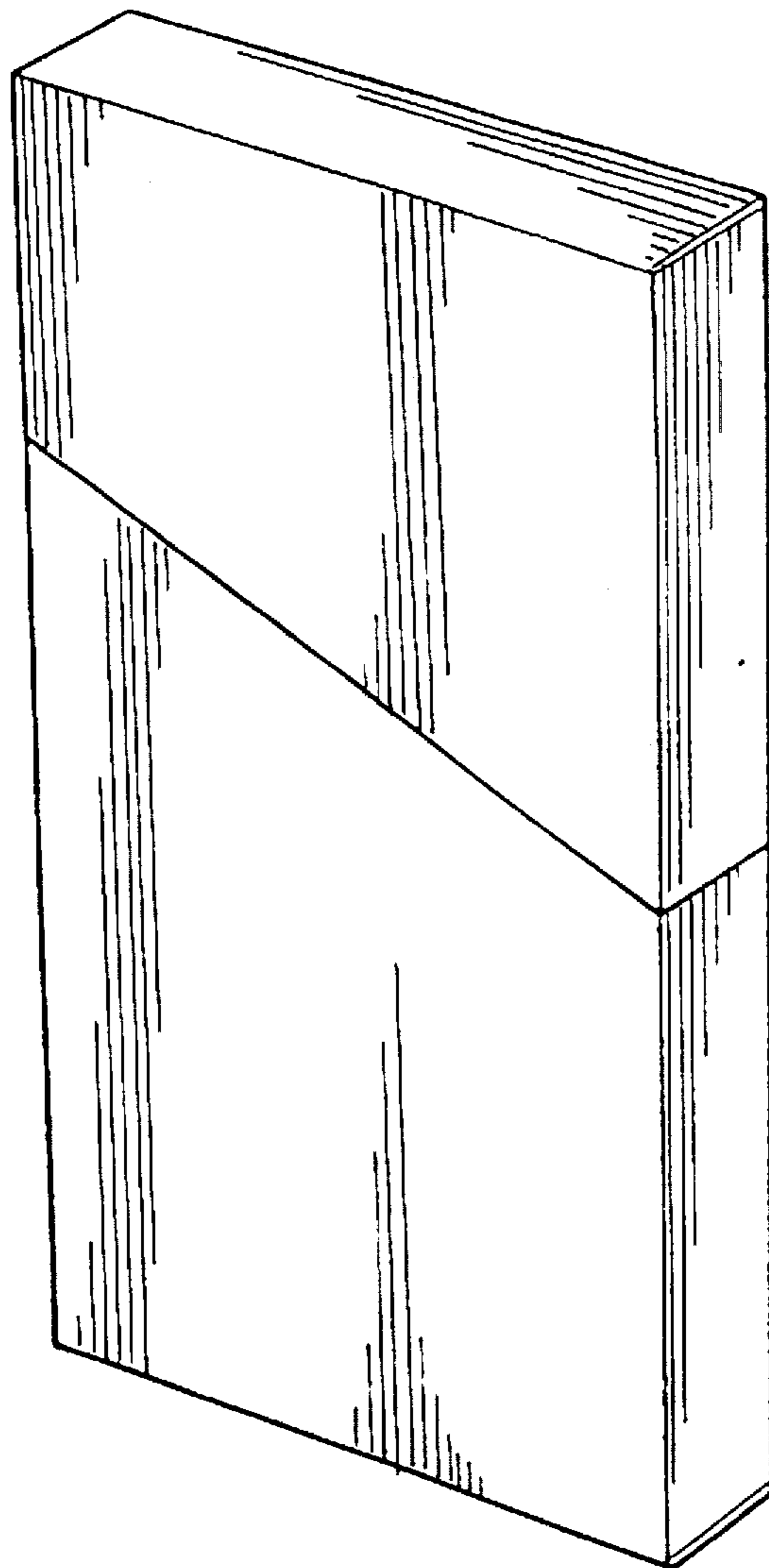

FIG. 8

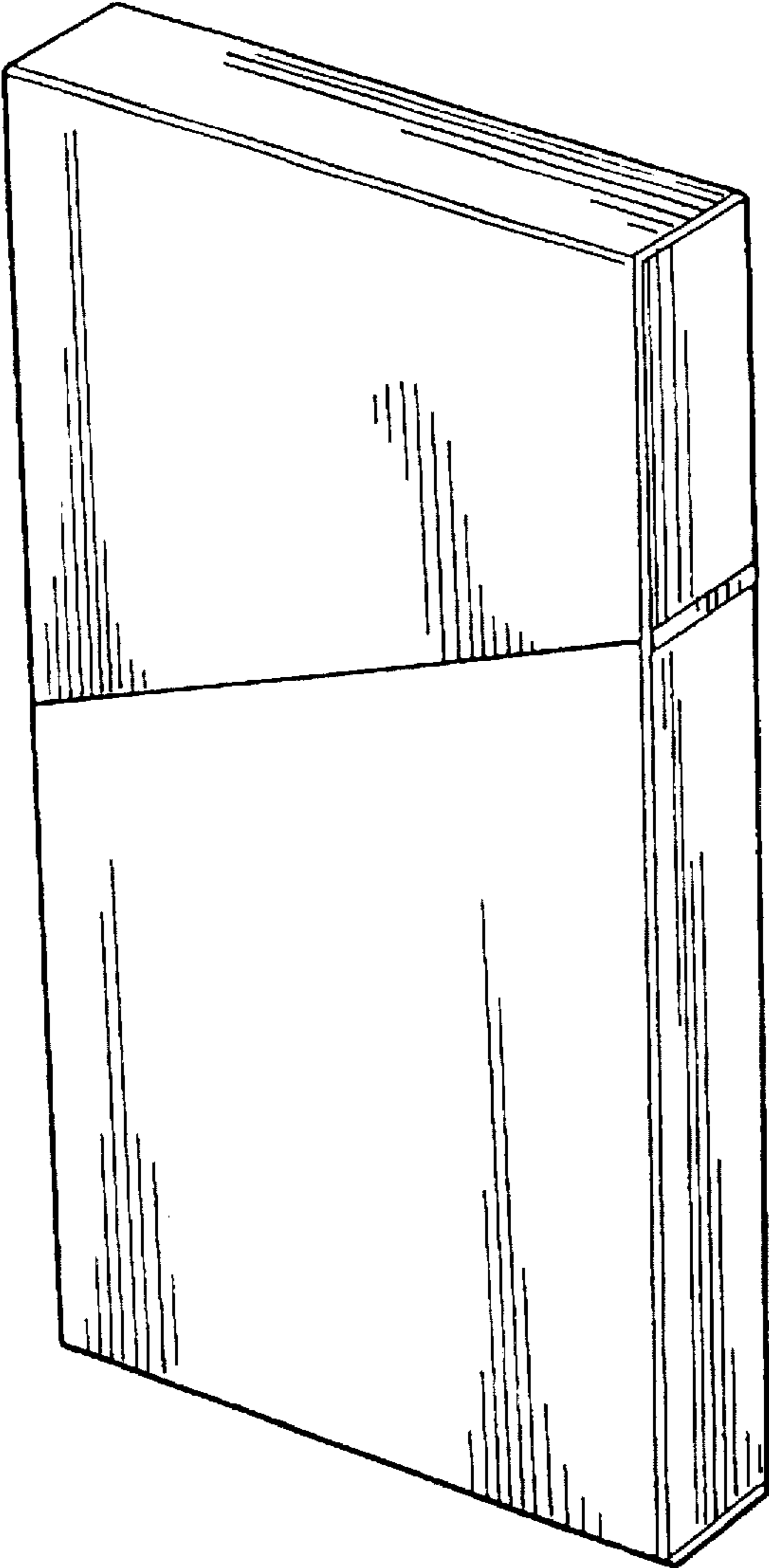

FIG. 9

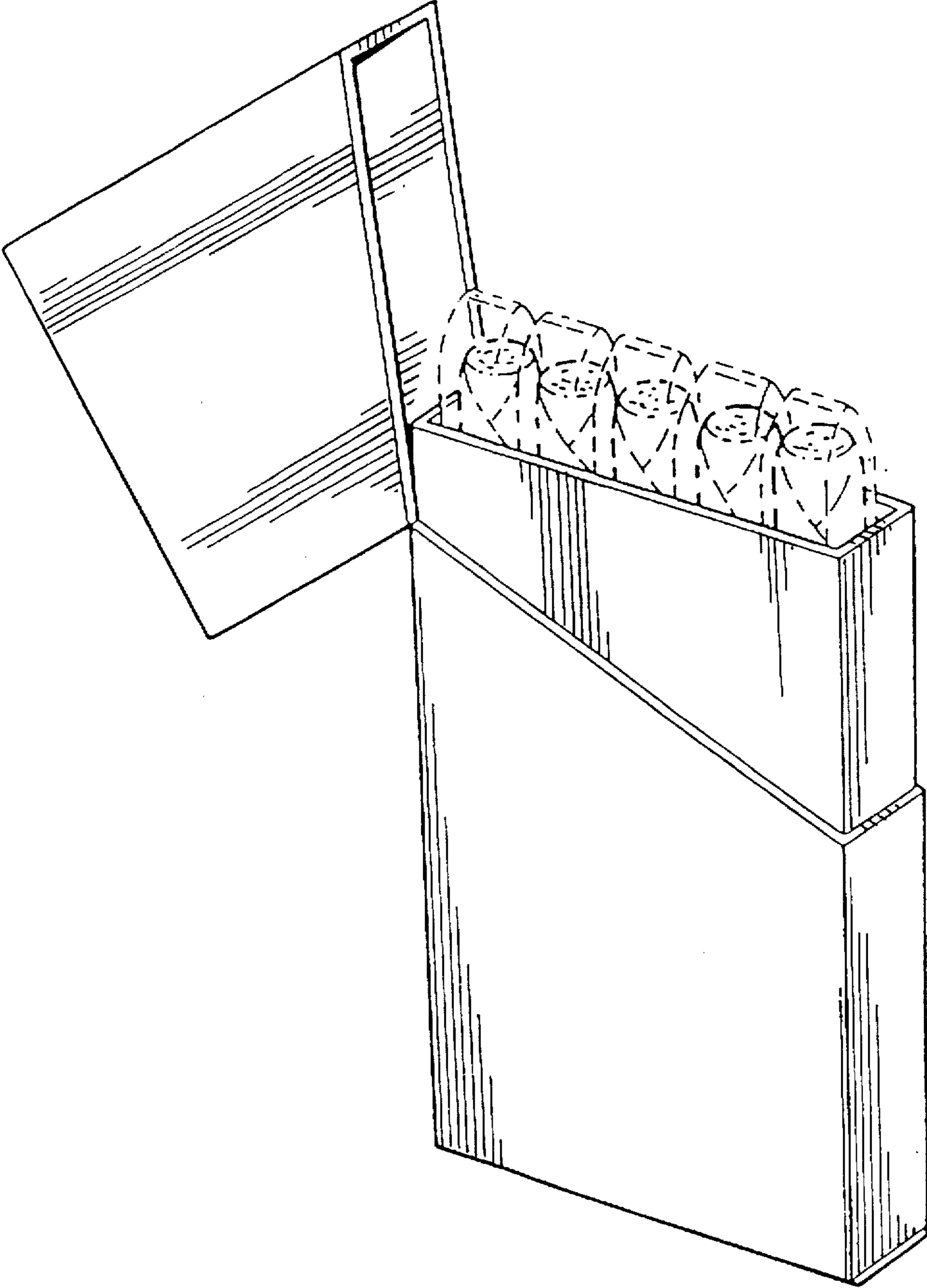
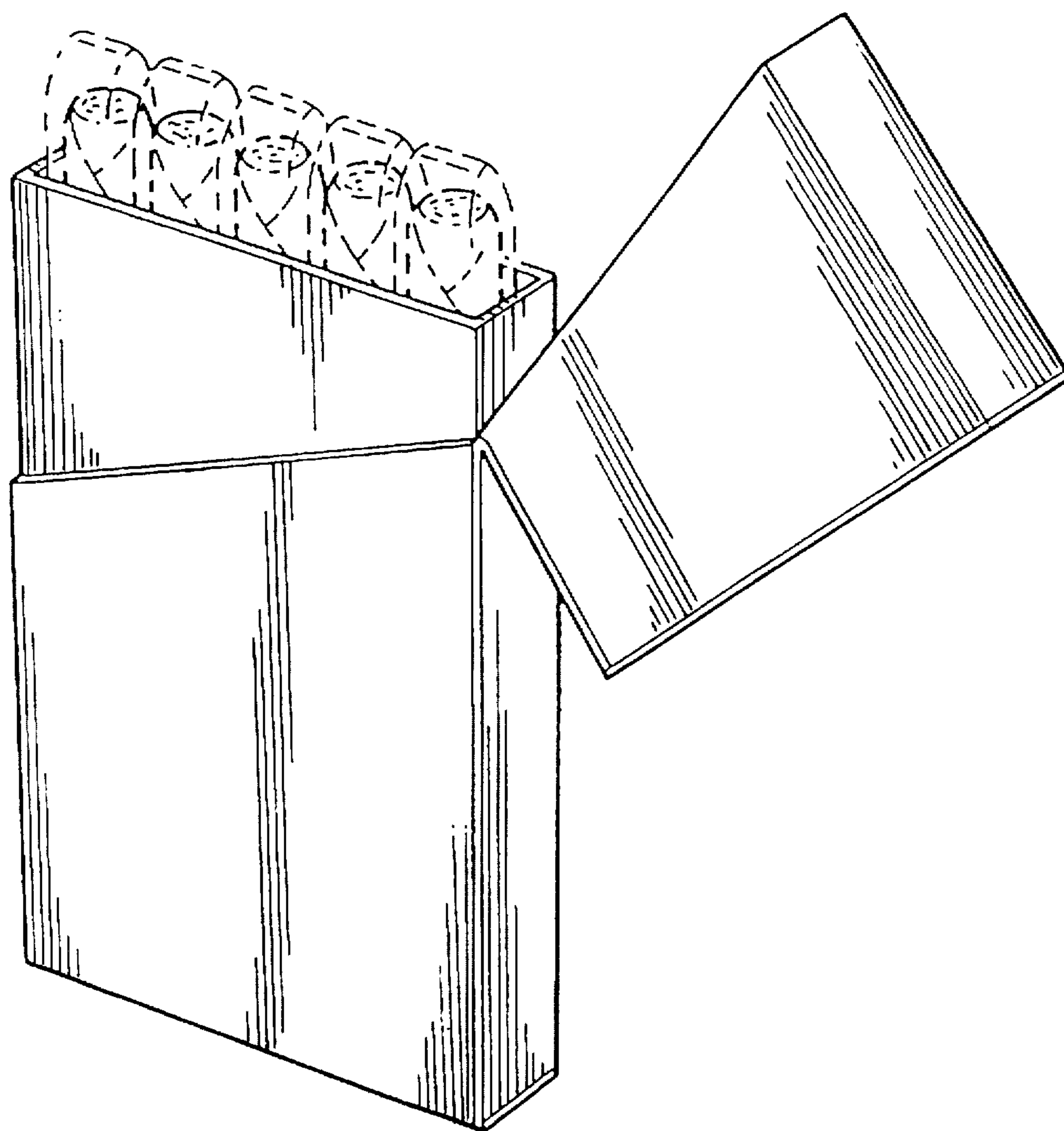

FIG. 10



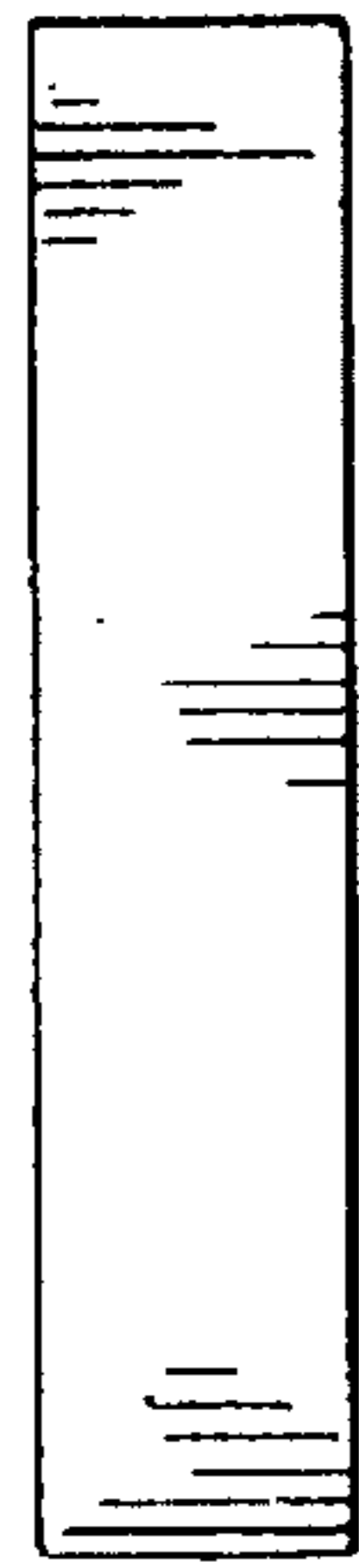

FIG. 12

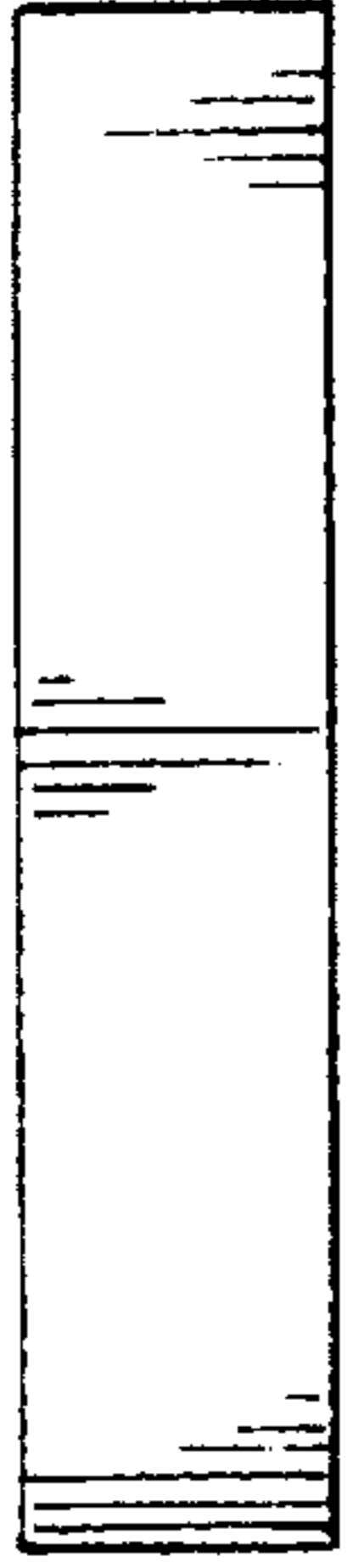

FIG. 13

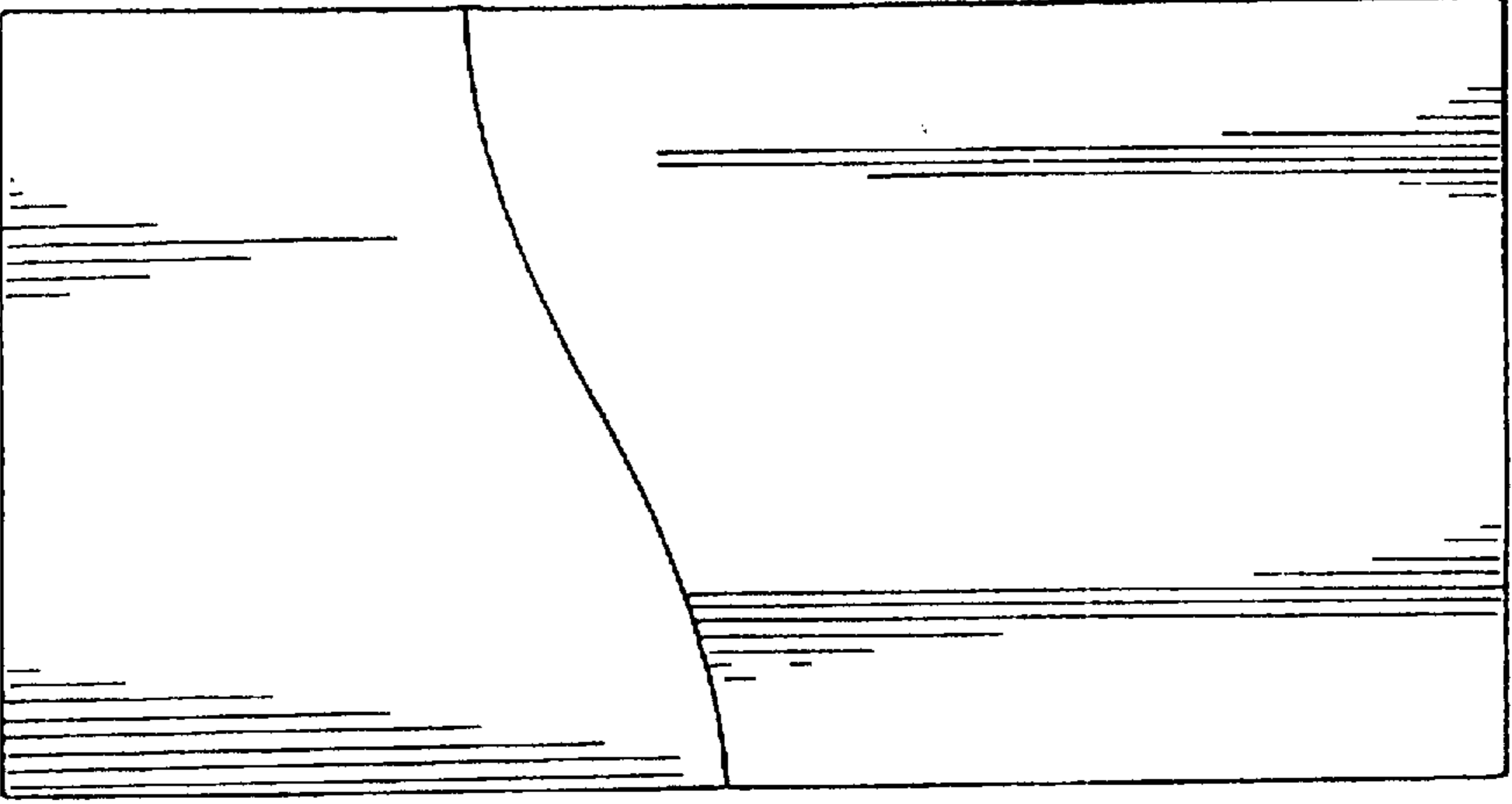
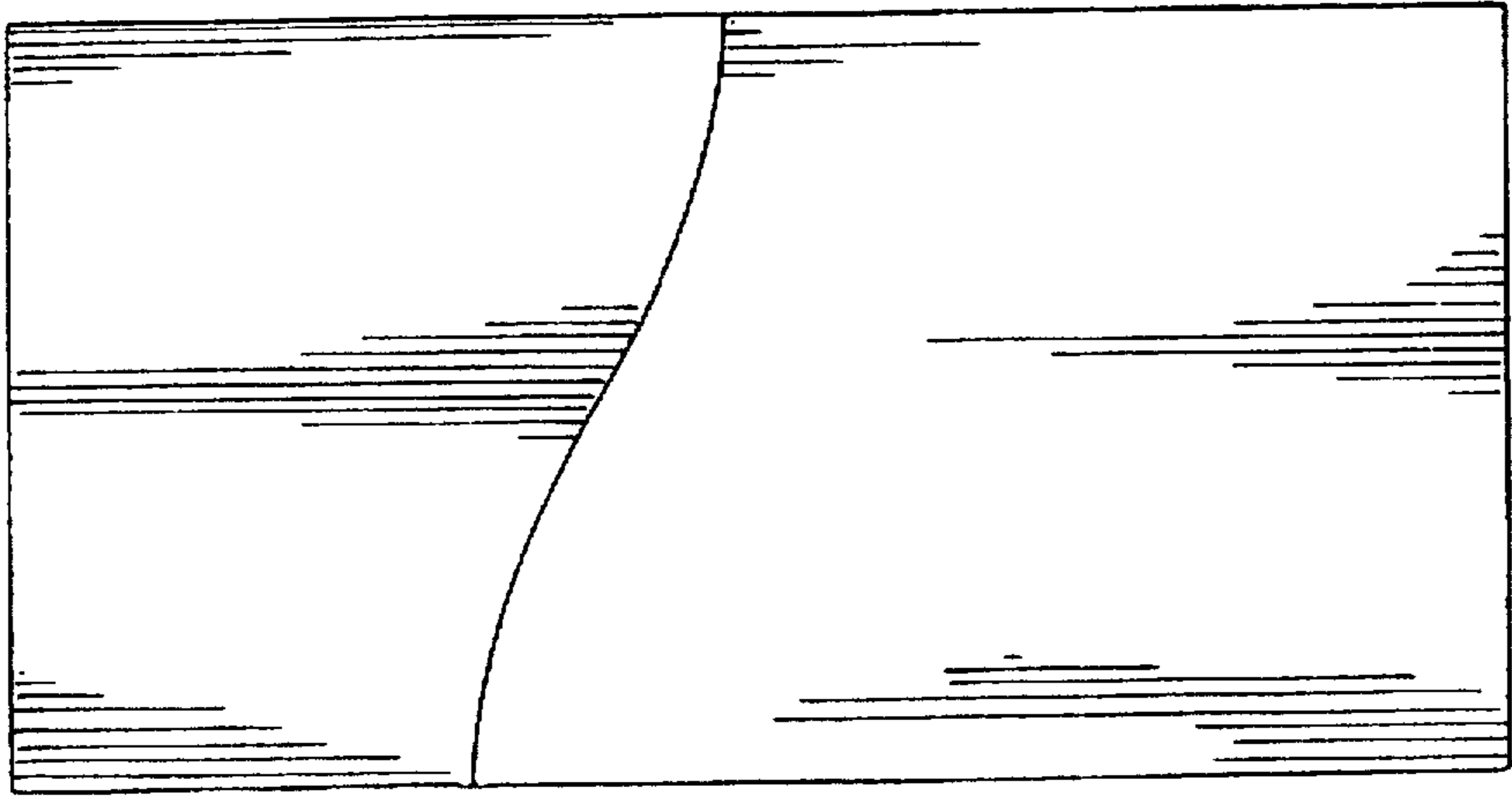
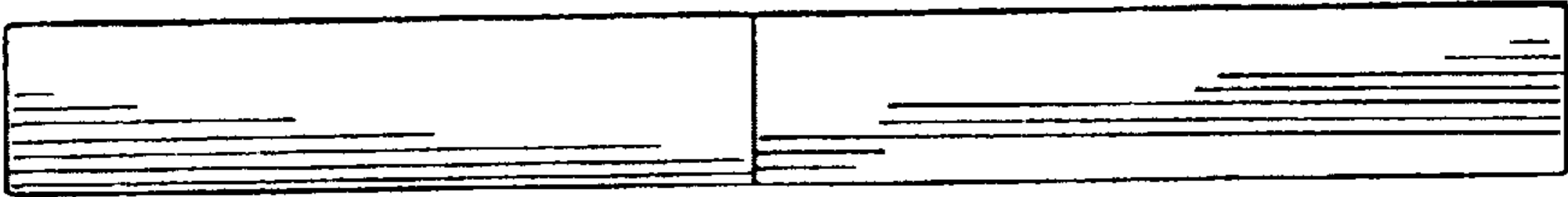
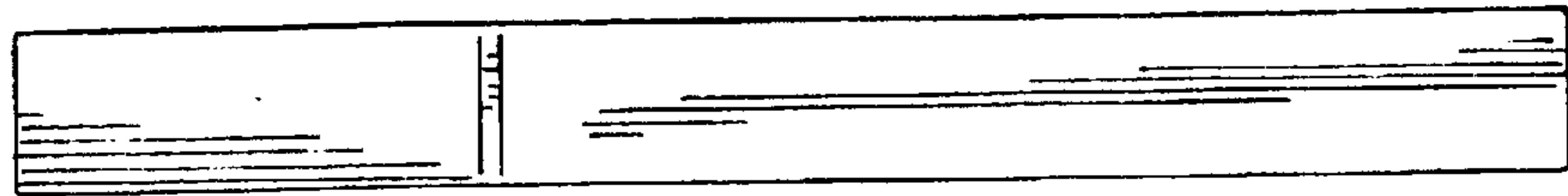

FIG. 14

FIG. 15

FIG. 16

FIG. 17

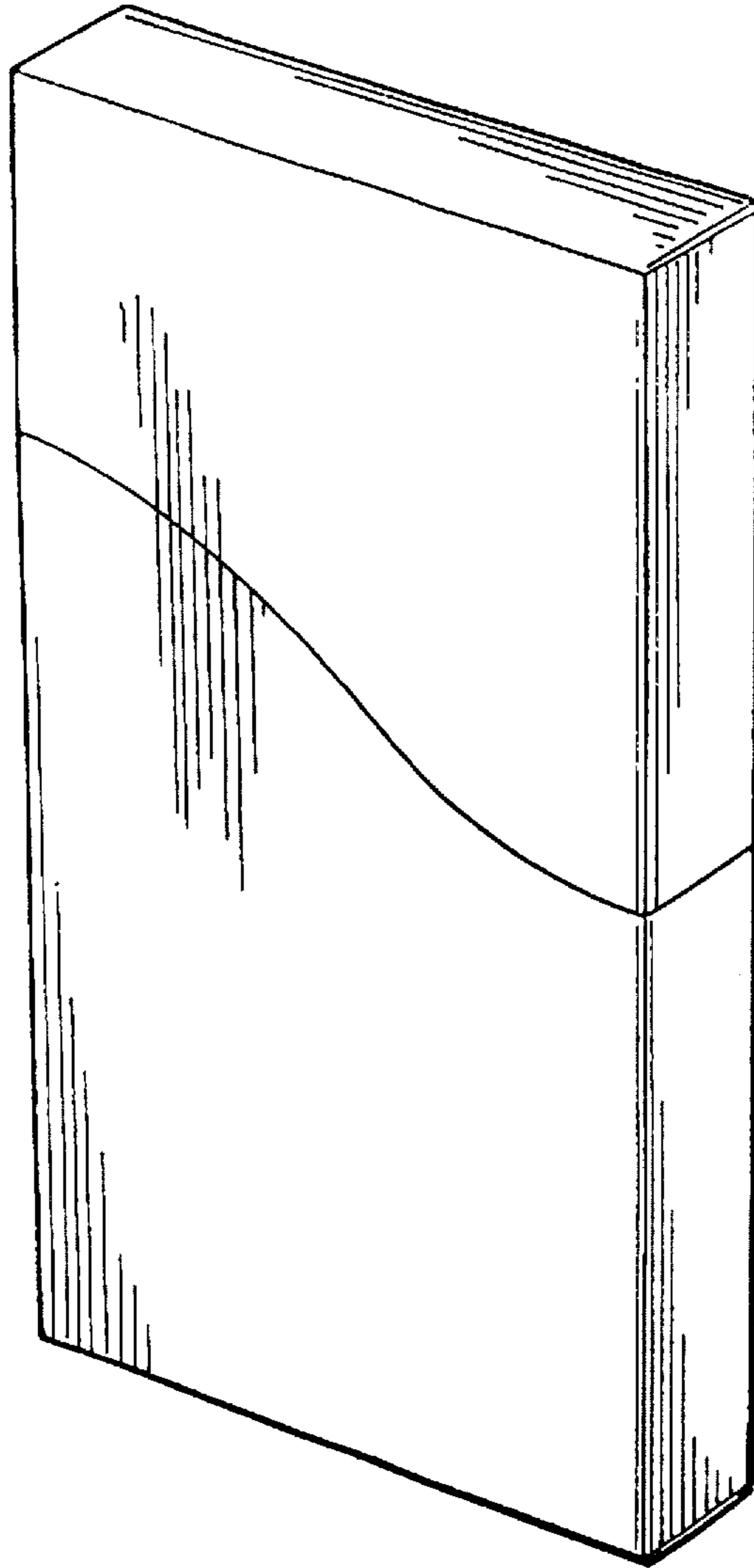

FIG. 17



FIG. 18

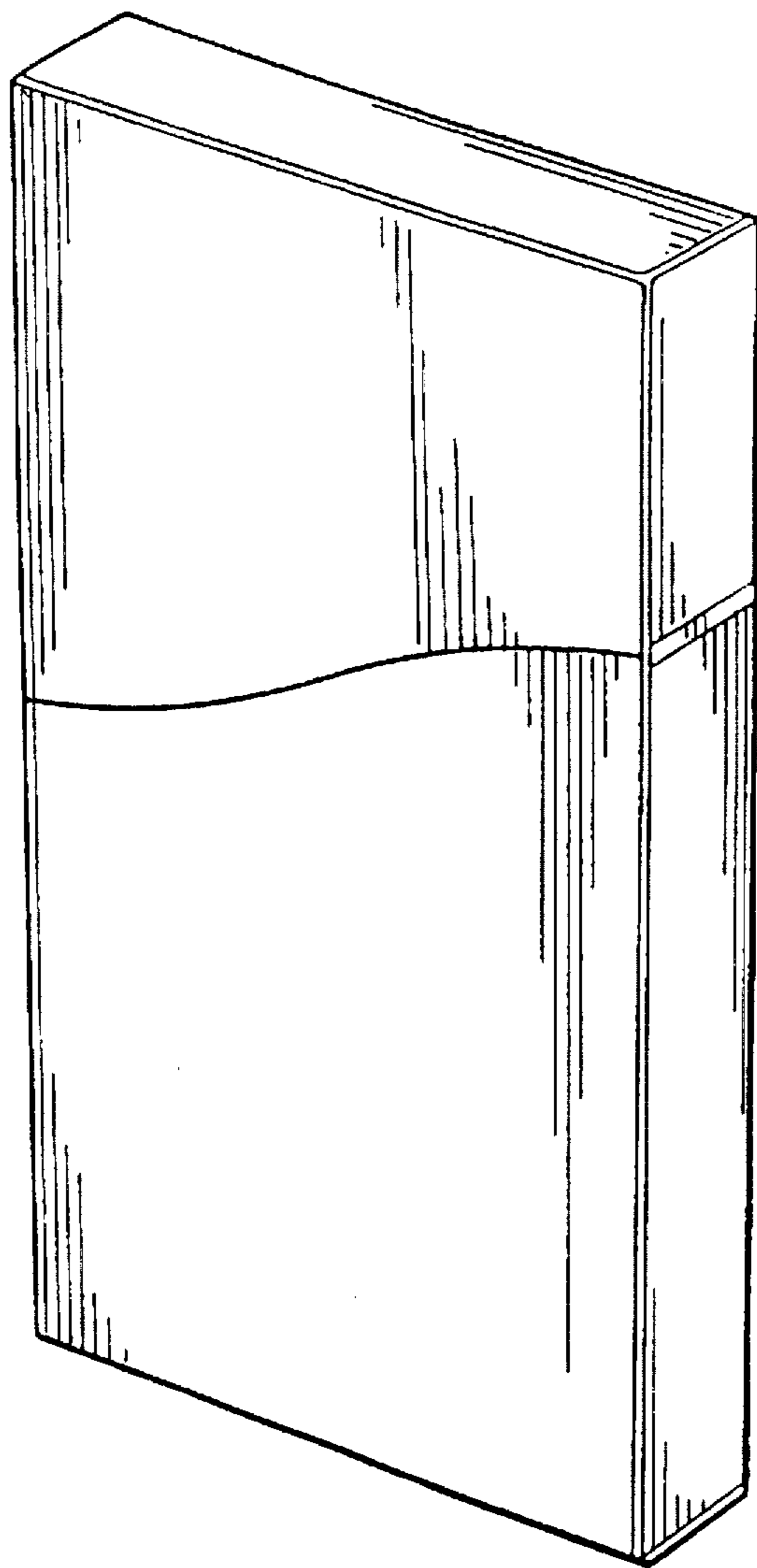

FIG. 19

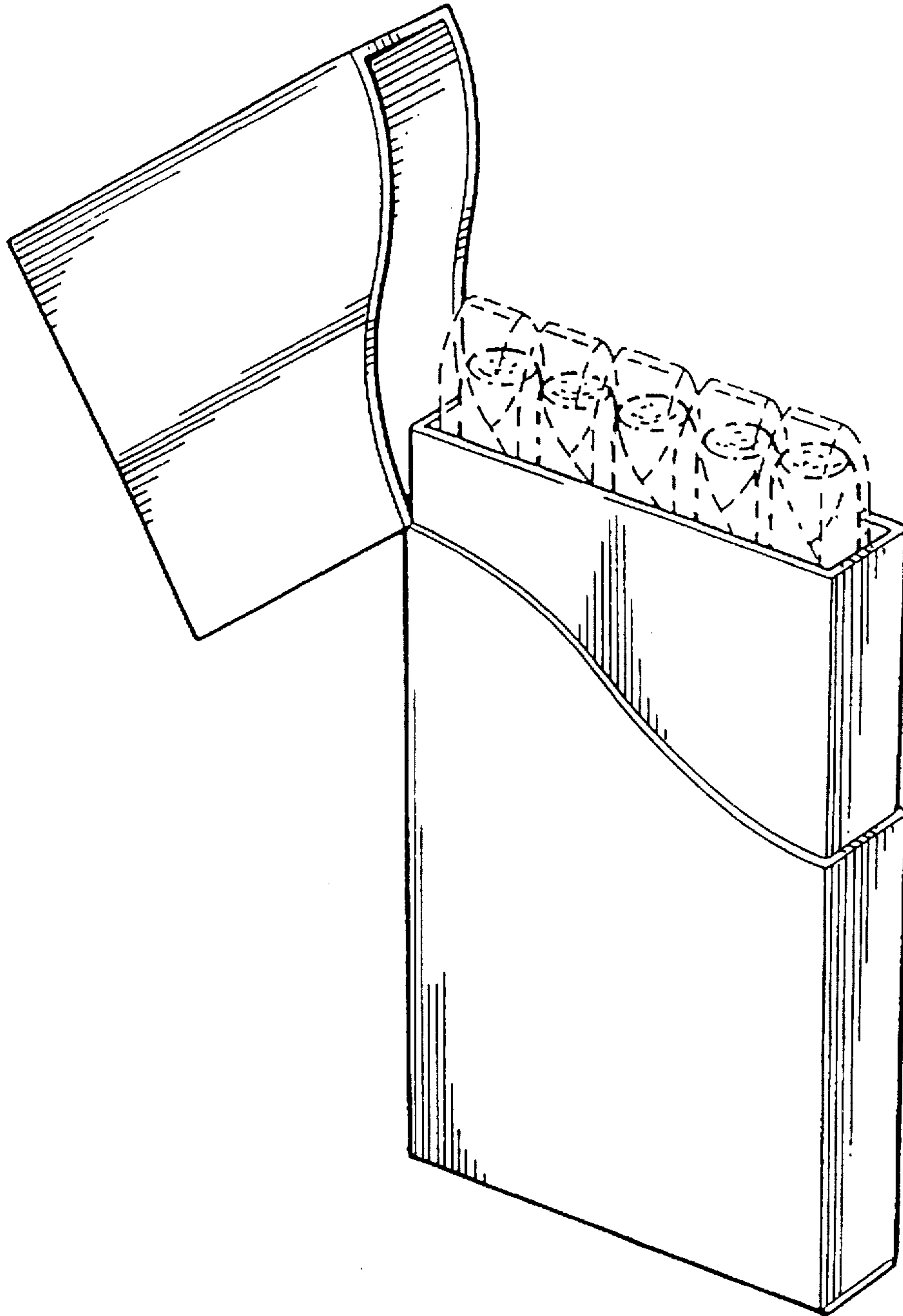

FIG. 20

