



US00D393833S

# United States Patent [19]

Aderman et al.

[11] Patent Number: **Des. 393,833**

[45] Date of Patent: **\*\*Apr. 28, 1998**

[54] **DESKSIDE DATA PROCESSING SYSTEM**

[75] Inventors: **Wayne Lowell Aderman**, Zumbro Falls; **Tim Kerry Murphy**, Rochester, both of Minn.

[73] Assignee: **International Business Machines Corporation**, Armonk, N.Y.

[\*\*] Term: **14 Years**

[21] Appl. No.: **60,734**

[22] Filed: **Oct. 4, 1996**

[51] LOC (6) Cl. .... **14-02**

[52] U.S. Cl. .... **D14/100**

[58] Field of Search ..... D14/100, 102, D14/107-109; D6/432, 436, 445, 448; D13/162, 184, 199, 110; 312/208.1, 254, 292; 360/98.01; 361/694, 696, 683

[56] **References Cited**

**U.S. PATENT DOCUMENTS**

- D. 340,031 10/1993 Hill ..... D13/162
- D. 349,488 8/1994 Aderman et al. .... D14/109
- D. 351,147 10/1994 Hill ..... D14/109

- D. 360,405 7/1995 Hill et al. .... D14/100
- D. 360,406 7/1995 Hill et al. .... D14/100
- D. 361,538 8/1995 Hill et al. .... D13/110
- D. 366,249 1/1996 Hill et al. .... D14/100
- D. 366,462 1/1996 Hill et al. .... D14/100
- D. 366,648 1/1996 Hill et al. .... D14/100
- D. 366,651 1/1996 Hill et al. .... D14/107
- D. 369,350 4/1996 Takahashi ..... D14/100

*Primary Examiner*—Freda Nunn  
*Attorney, Agent, or Firm*—Matthew J. Bussan

[57] **CLAIM**

The ornamental design for a deskside data processing system, as shown and described.

**DESCRIPTION**

FIG. 1 is a top, front, right side isometric view of a deskside data processing system, showing our new design; FIG. 2 is a front elevational view thereof; FIG. 3 is a right side elevational view thereof; FIG. 4 is a top plan view thereof; FIG. 5 is a left side elevational view thereof; and, FIG. 6 is a rear elevational view thereof. The bottom of the deskside data processing system is unornamented.

**1 Claim, 6 Drawing Sheets**

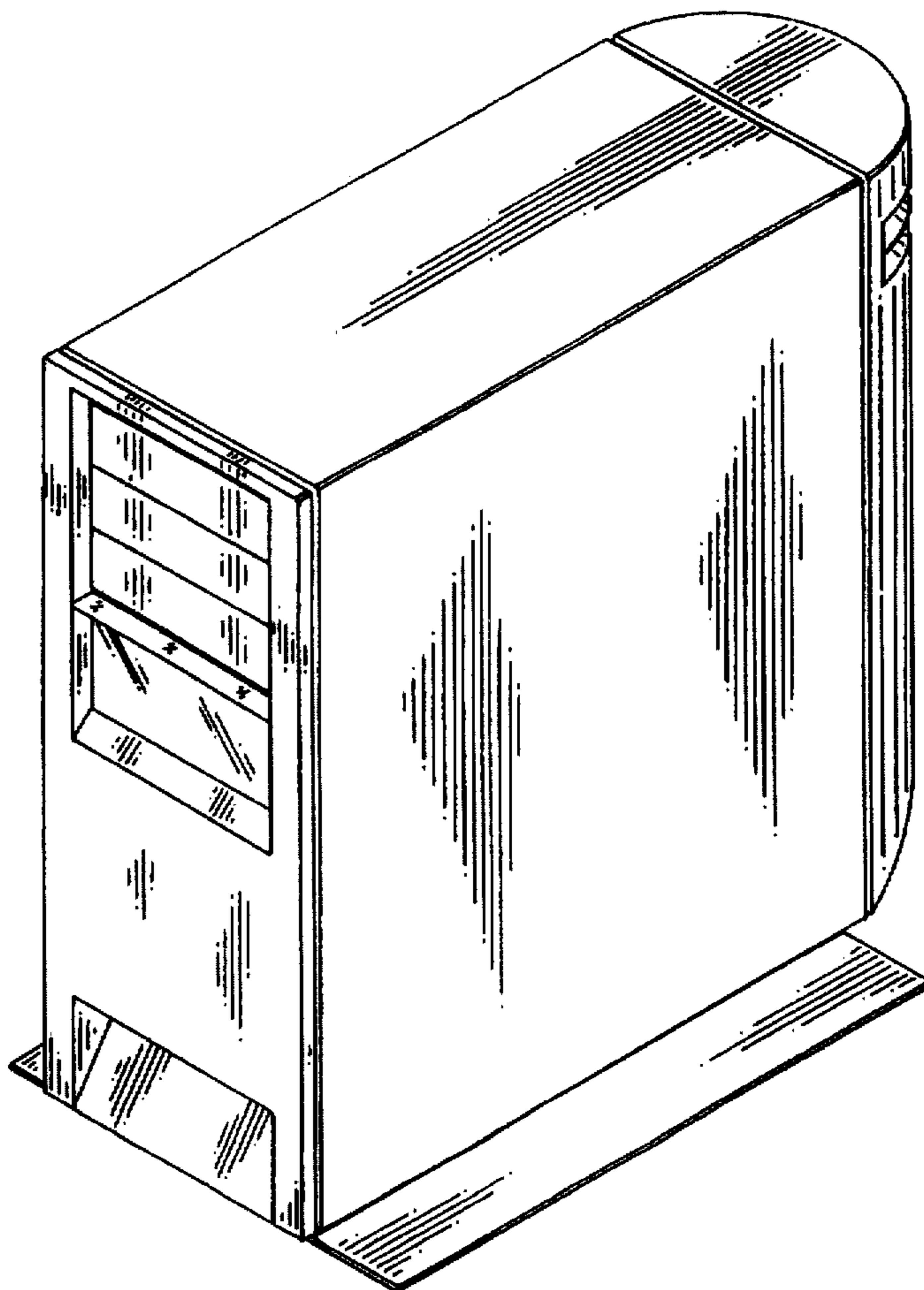

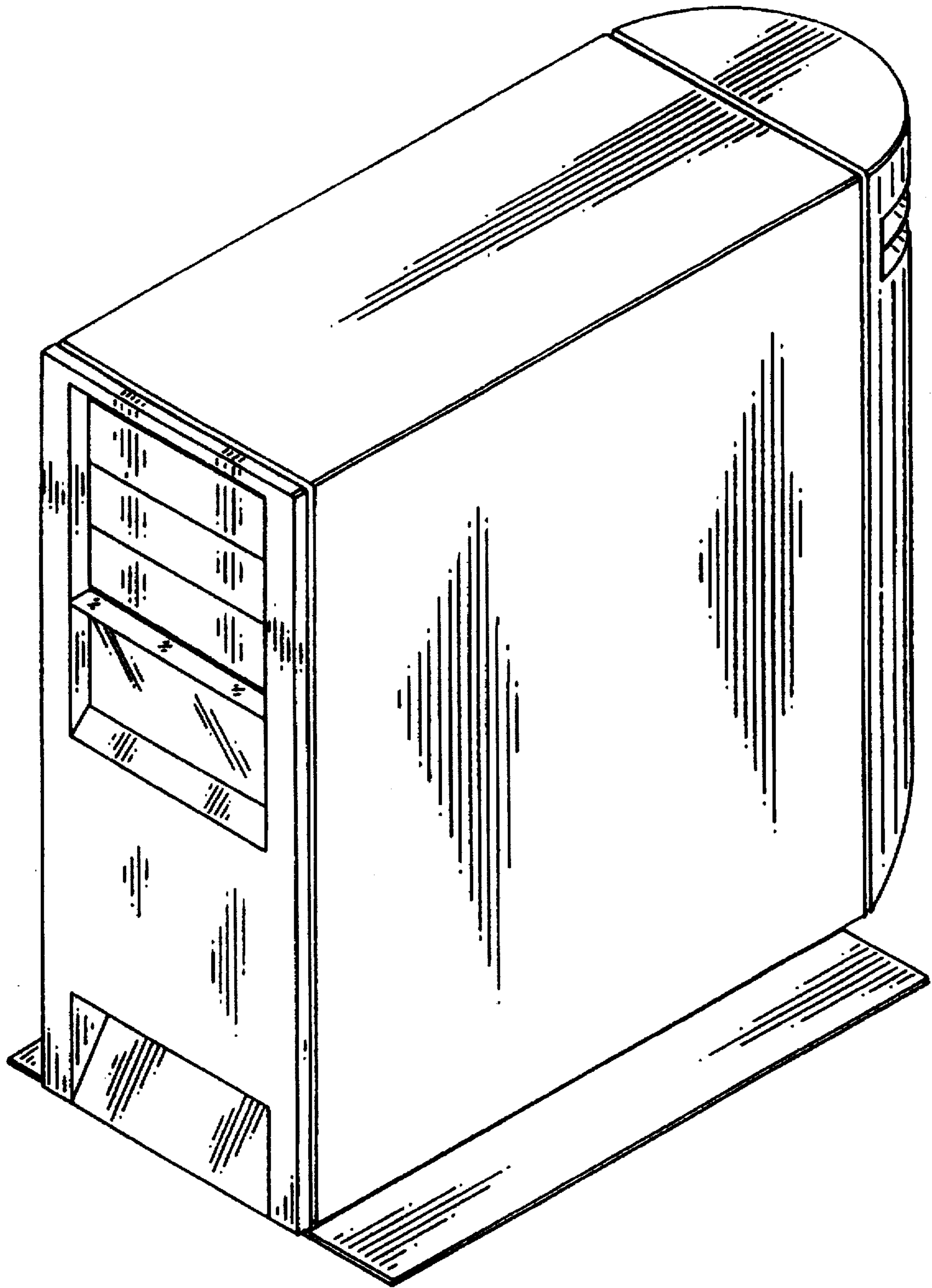

FIG. 1

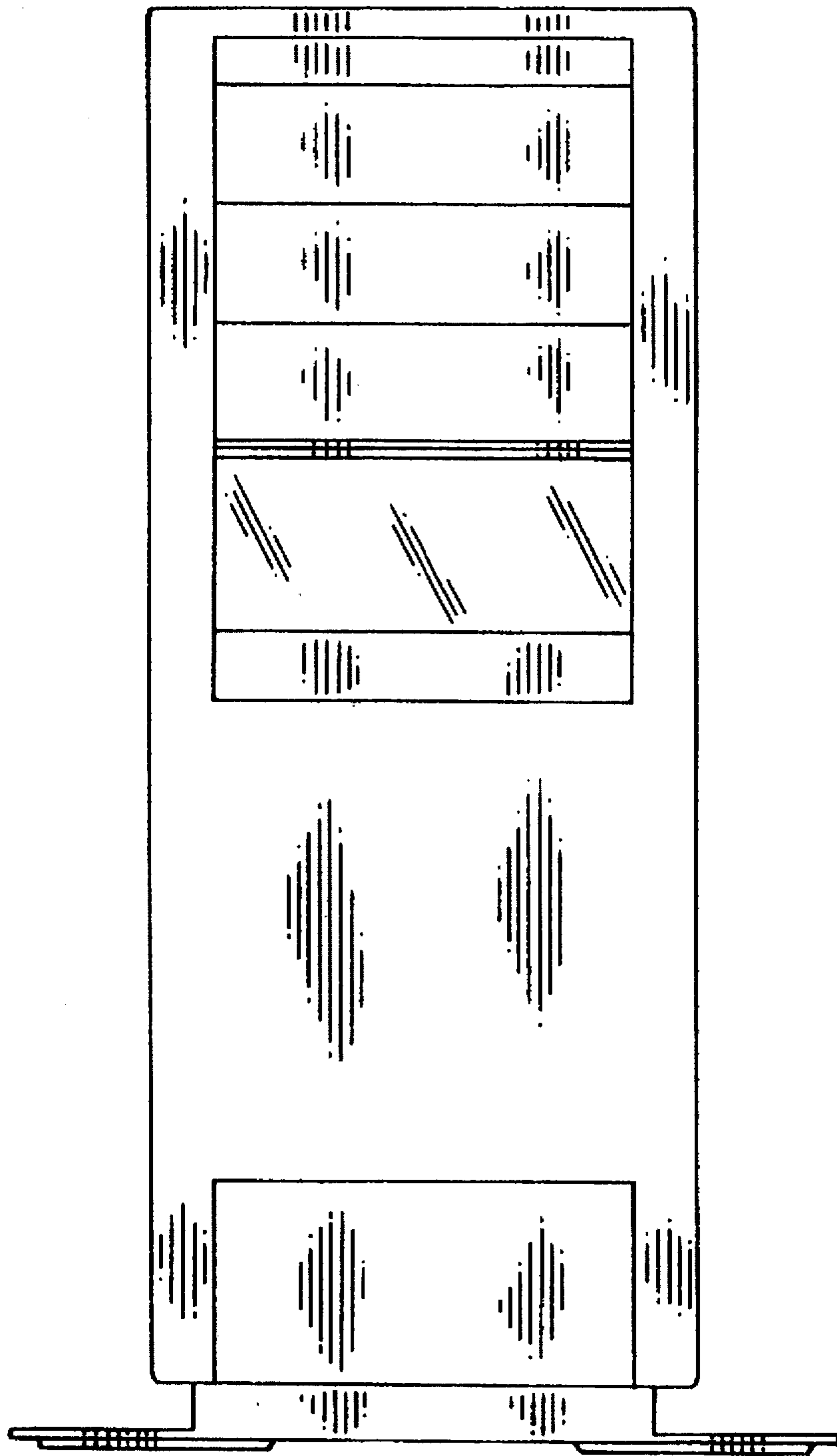

FIG. 2

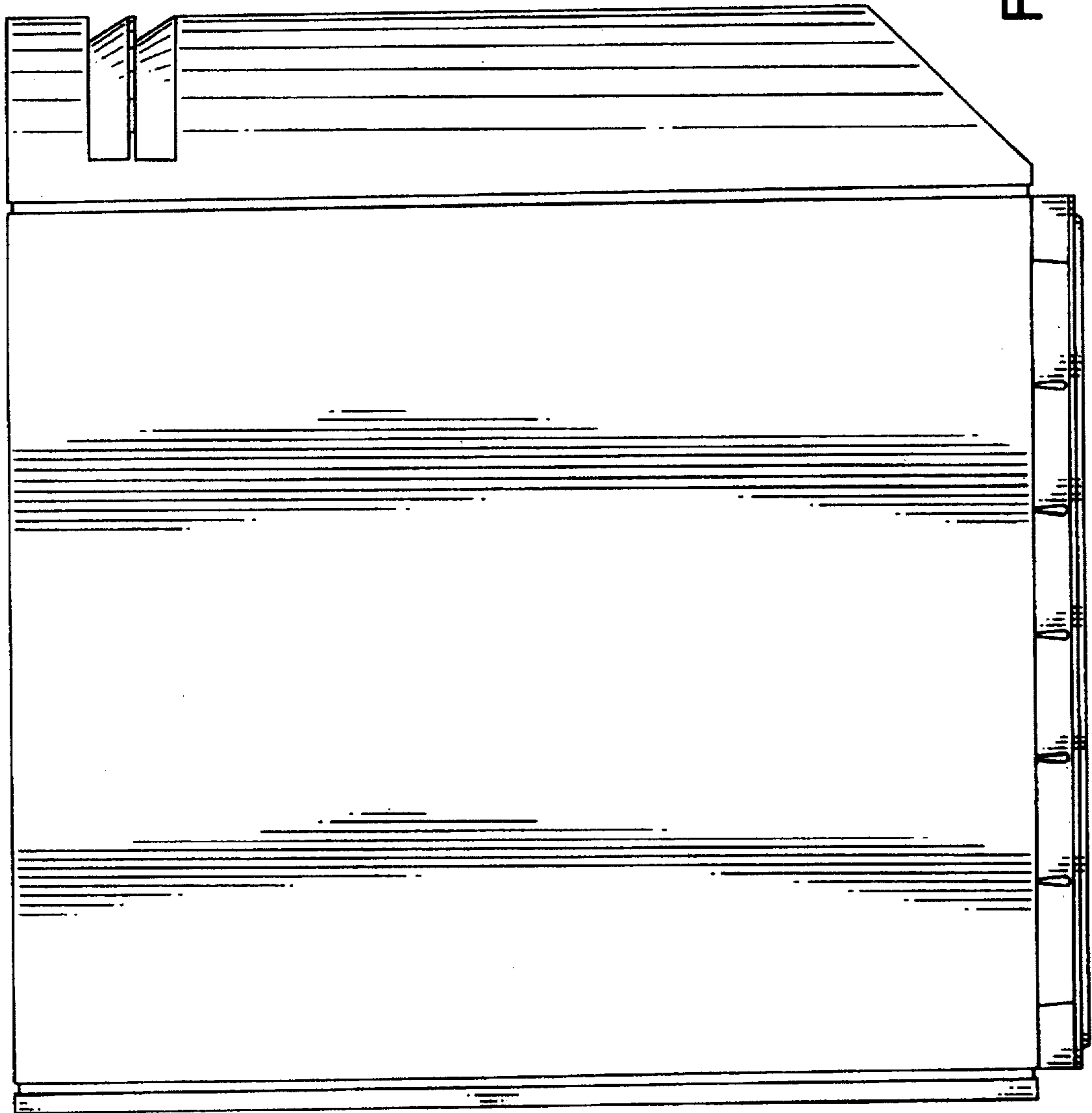

FIG. 3

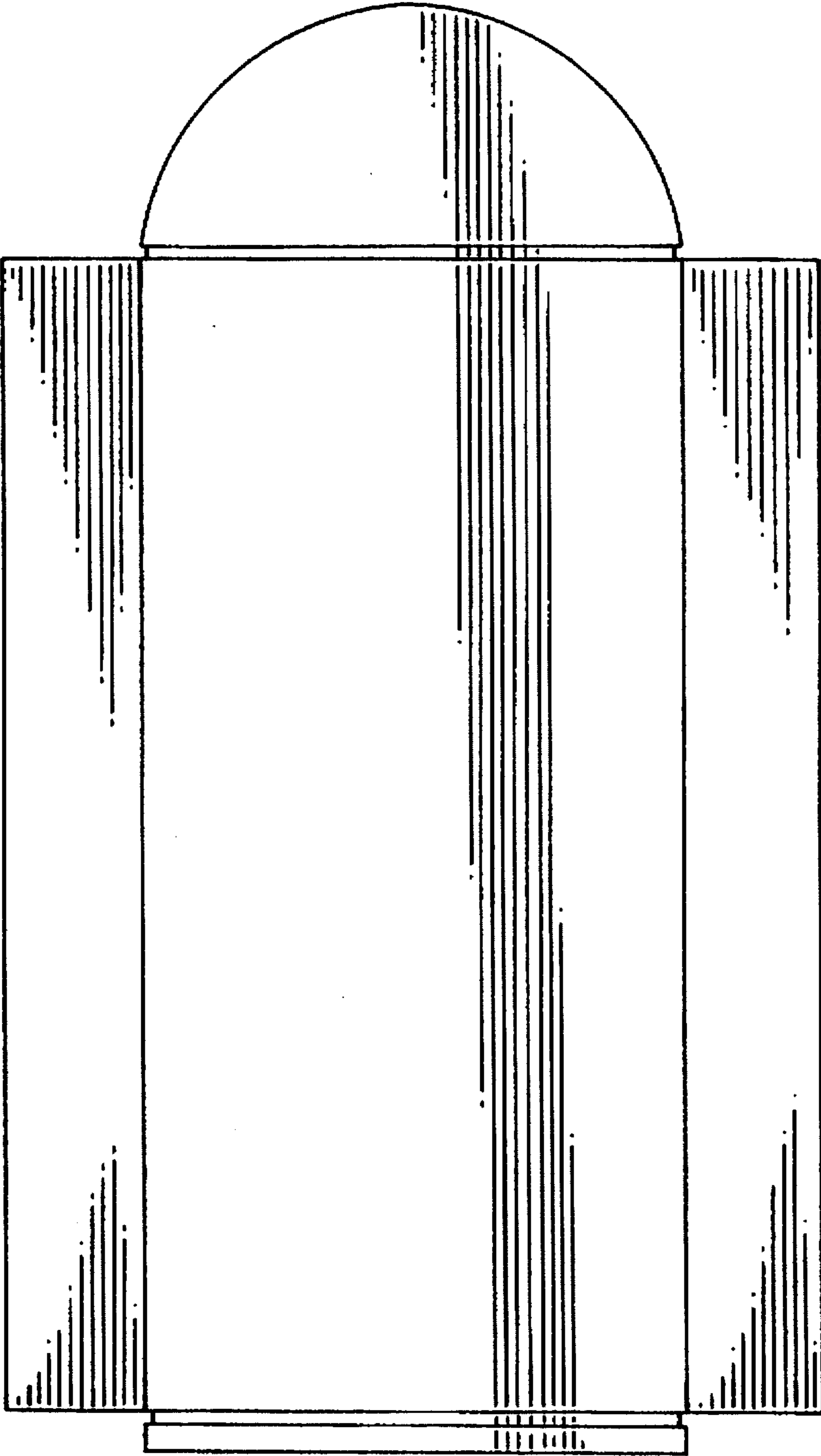
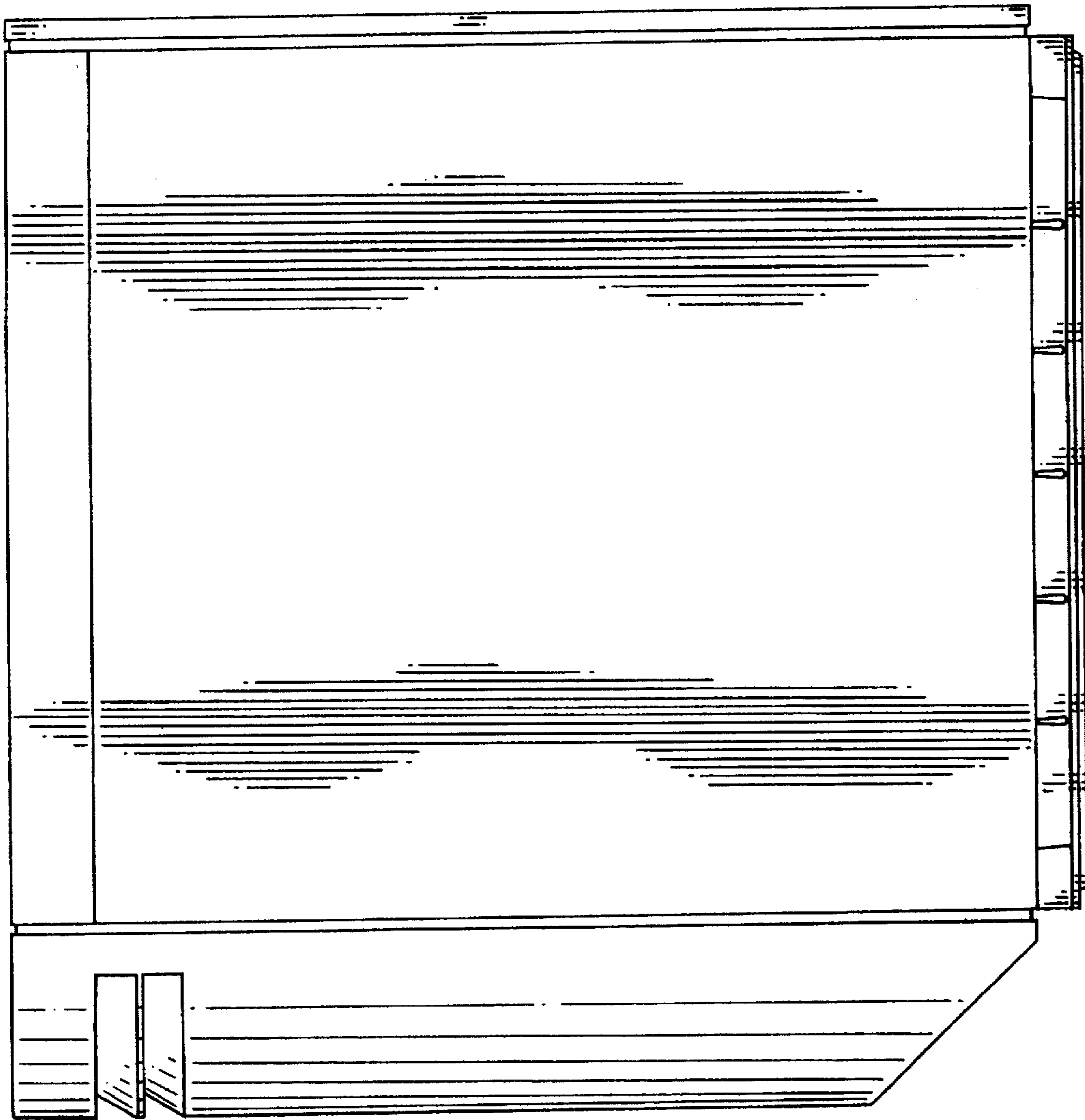

FIG. 4

FIG. 5



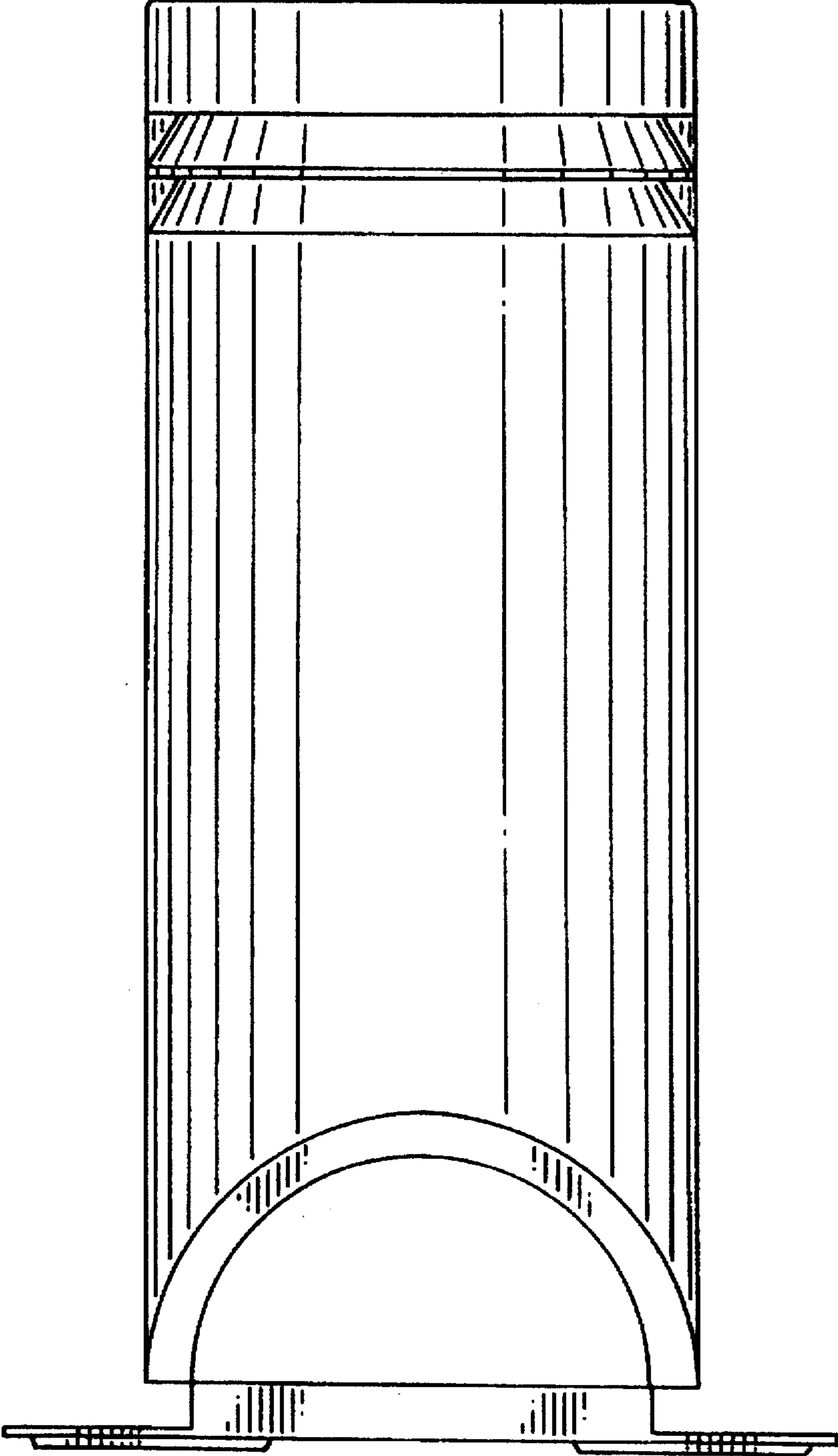

FIG. 6