

US00D393774S

# United States Patent [19]

Ashcraft et al.

[11] Patent Number: Des. 393,774

[45] Date of Patent: \*\*Apr. 28, 1998

[54] COMBINED THREE BURNER COOK TOP WITH OPEN BURNERS

5,046,477 9/1991 Bennett et al. .... 126/39 R  
5,119,802 6/1992 Cherry et al. .... 126/21 A

[75] Inventors: Walter M. Ashcraft, Schaumburg, Ill.;  
David Steele, Beloit, Wis.

Primary Examiner—Ruth McInroy  
Attorney, Agent, or Firm—Leydig, Voit & Mayer, Ltd.

[73] Assignee: Atwood Mobile Products, Rockford, Ill.

[57] CLAIM

[\*\*] Term: 14 Years

The ornamental design for the combined three burner cook top with open burners, as shown and described.

[21] Appl. No.: 64,724

DESCRIPTION

[22] Filed: Jan. 9, 1997

[51] LOC (6) Cl. .... 07-02

[52] U.S. Cl. .... D7/346

[58] Field of Search ..... D7/340, 346, 407-408,  
D7/363-367; 126/39 H, 39 J, 214 C, 214 R;  
219/443, 462, 446; 99/446

FIG. 1 is a top perspective view of a combined three burner cook top with open burners showing our new design. the counter top into which the cook top is normally recessed is shown in broken lines for illustrative purposes only and forms no part of the claimed design;

FIG. 2 is a top view thereof;

FIG. 3 is a front view thereof;

FIG. 4 is a back view thereof;

FIG. 5 is a side view thereof; and,

FIG. 6 is a side view thereof showing the side opposite that shown in FIG. 5.

The bottom frame of the cook top shown in broken lines in FIGS. 1 and 3-6 is for illustrative purposes only and forms no part of the claimed design.

[56] References Cited

U.S. PATENT DOCUMENTS

D. 343,336	1/1994	Falk	.....	D7/407
D. 343,989	2/1994	Falk	.....	D7/407
D. 372,630	8/1996	Lewis et al.	.....	D7/346
3,044,459	7/1962	Brown	.....	126/39 H

1 Claim, 2 Drawing Sheets

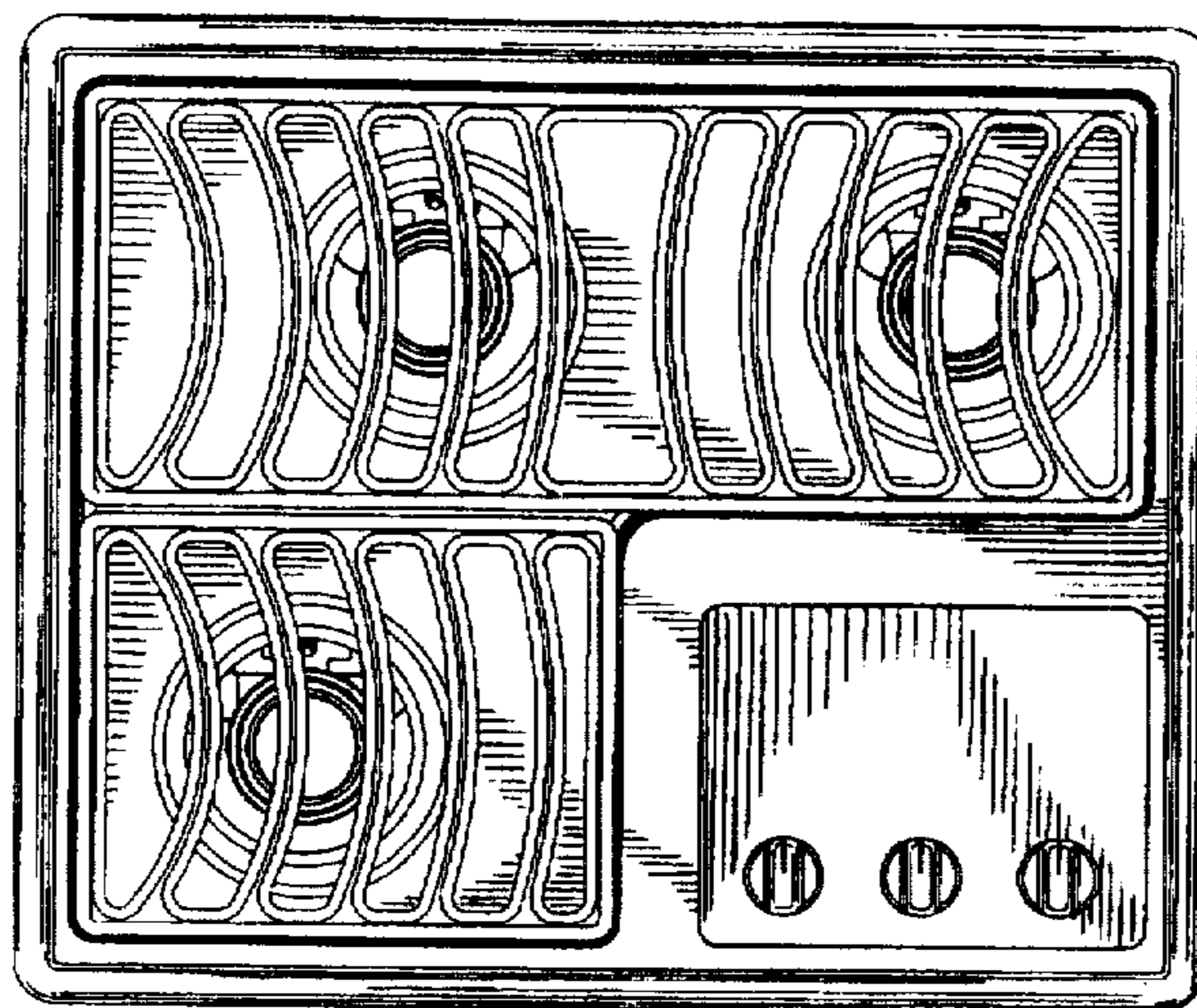
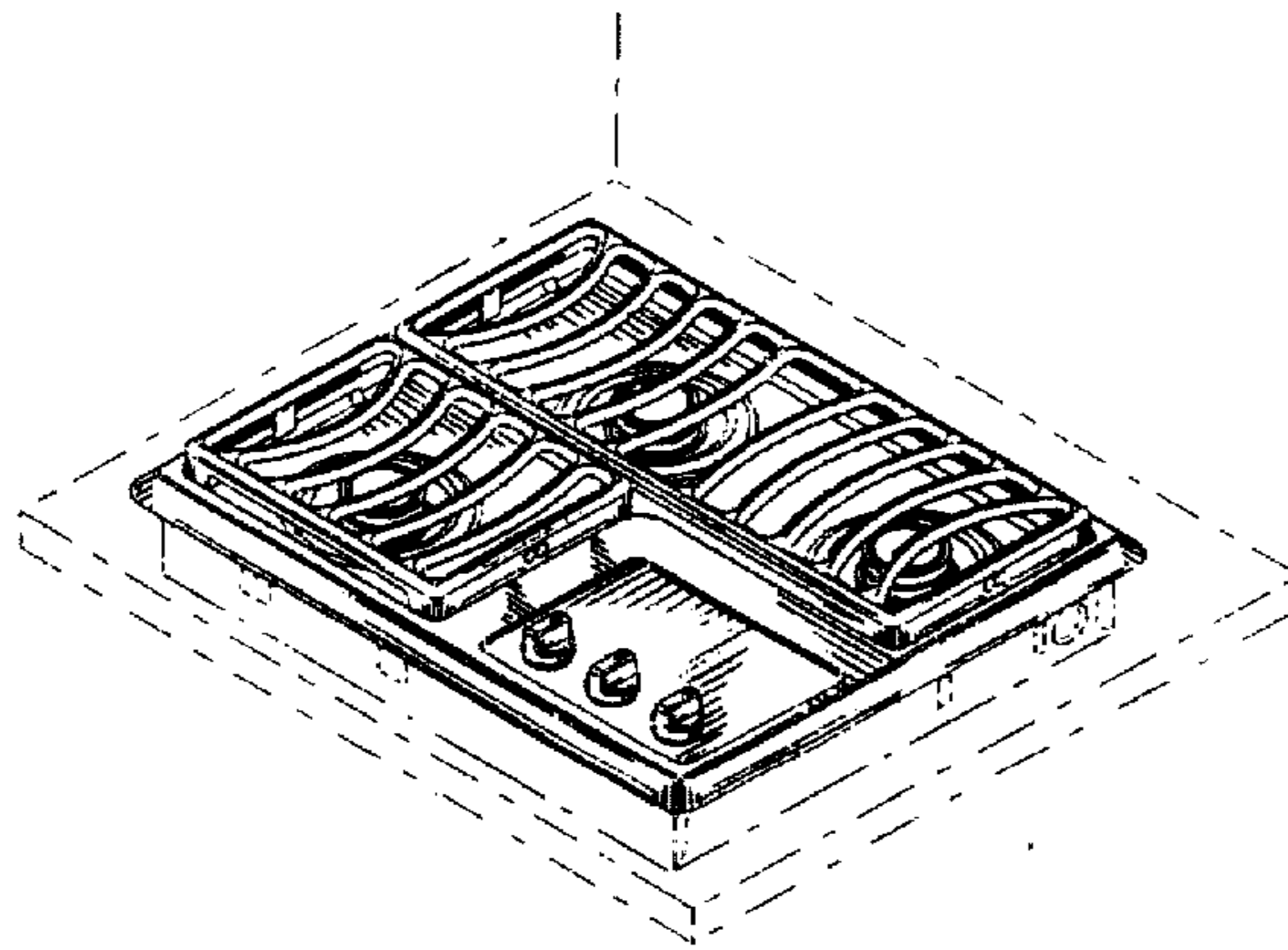

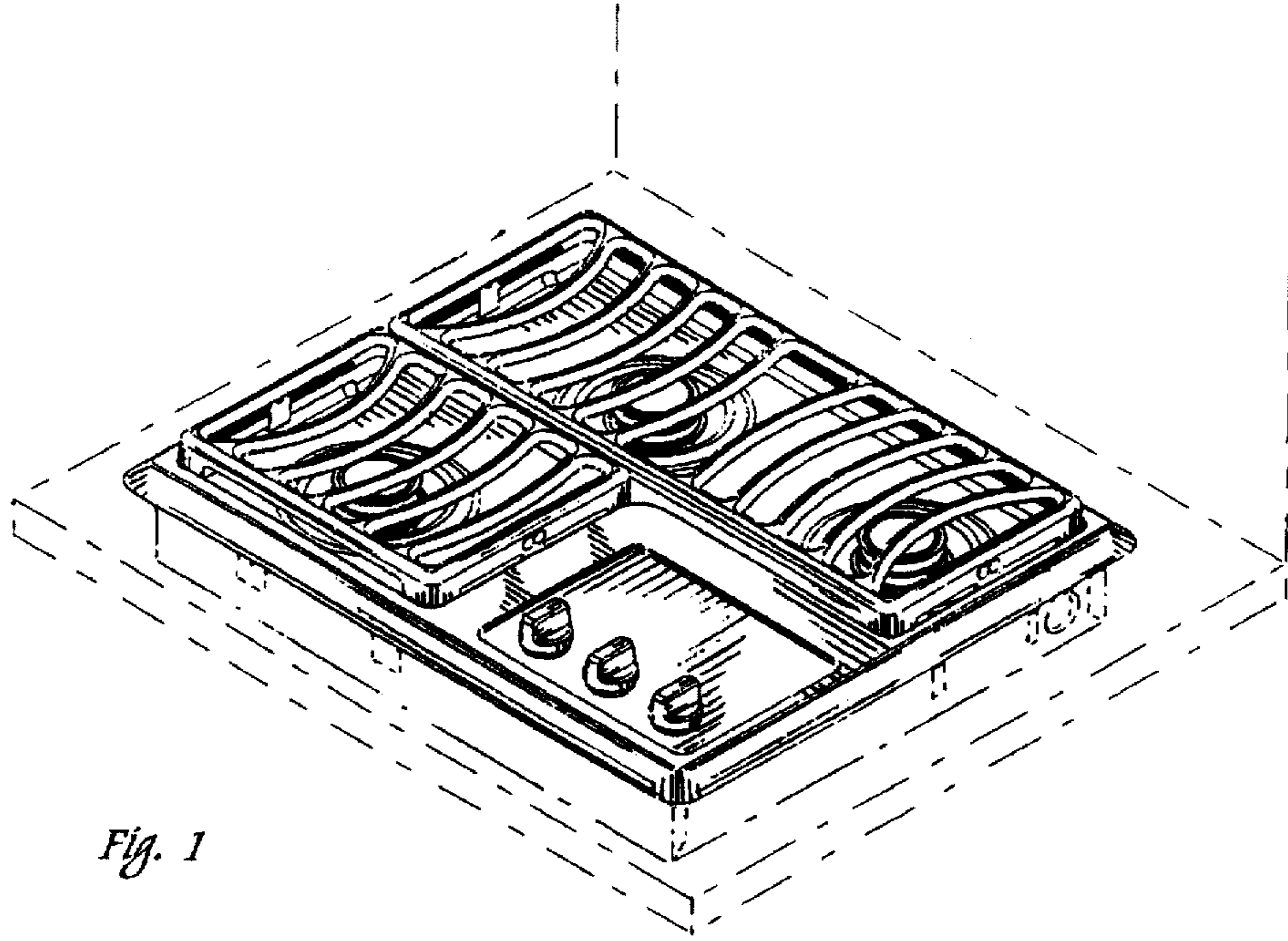

Fig. 1

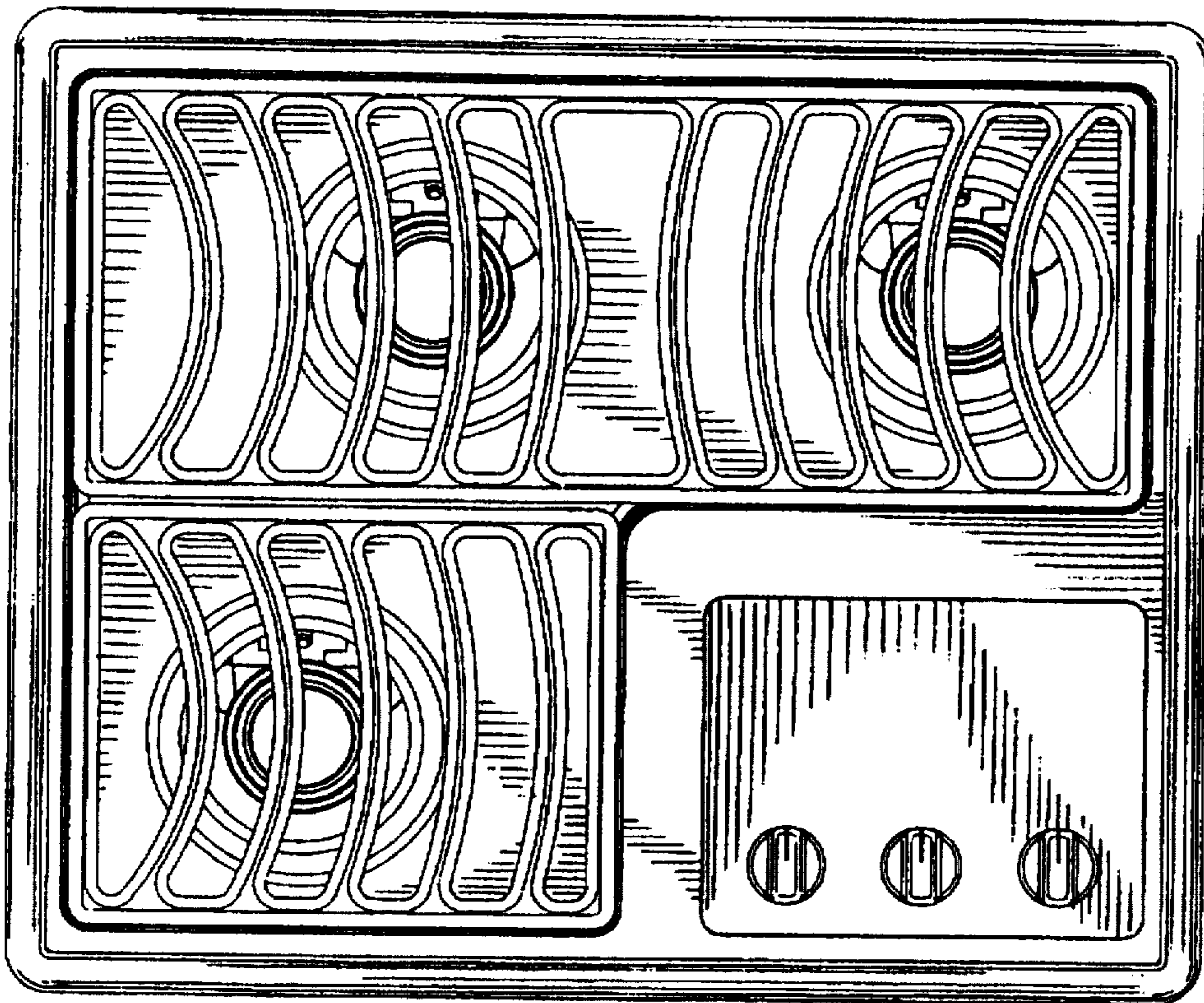

Fig. 2

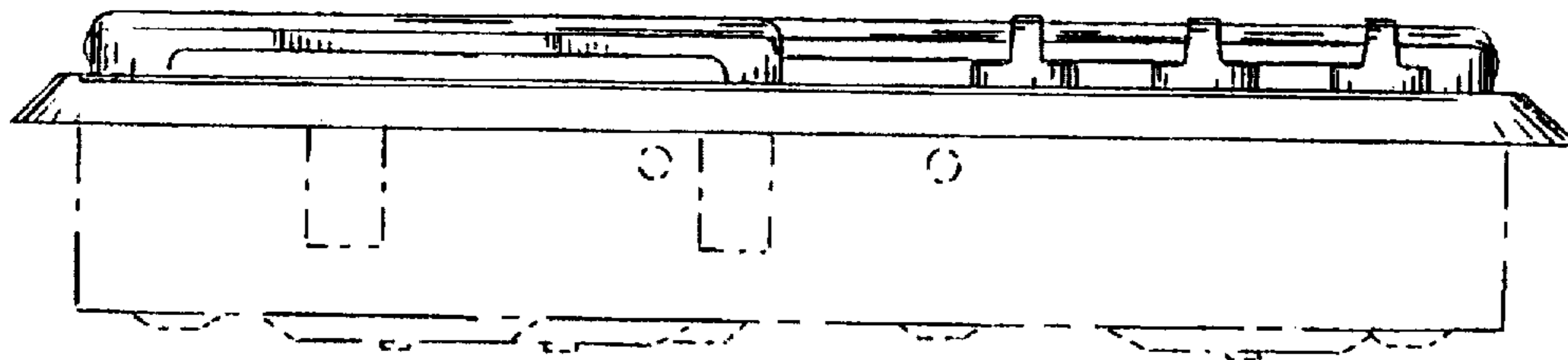

Fig. 3

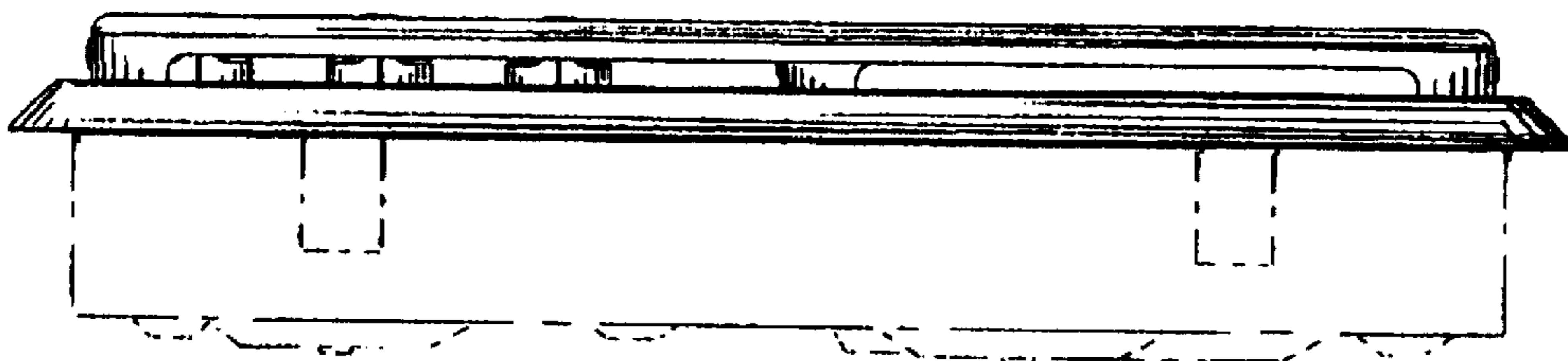

Fig. 4

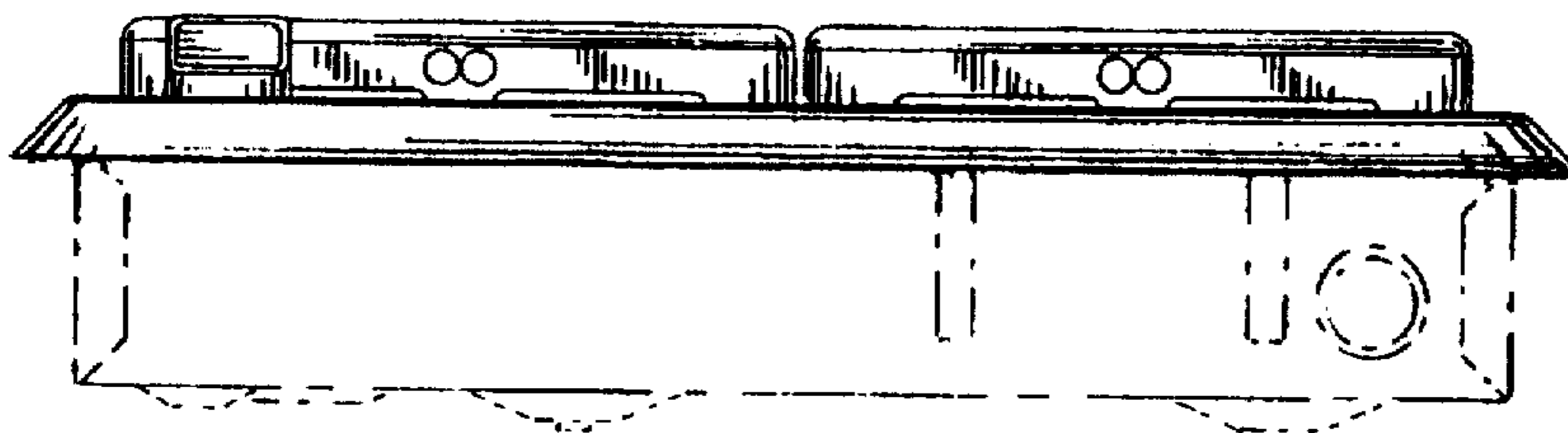

Fig. 5

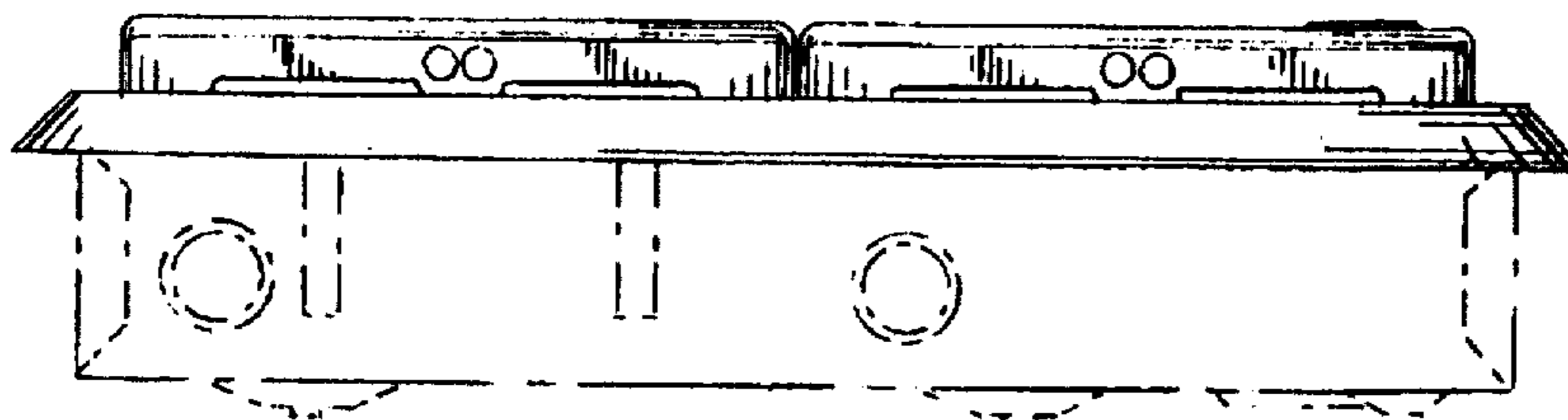

Fig. 6