



US00D393737S

United States Patent [19]

Tymous

[11] Patent Number: Des. 393,737

[45] Date of Patent: **Apr. 28, 1998

[54] NURSING BLANKET

[76] Inventor: **Karen Jean Tymous**, 2016 6th Ave.,
Beaver Falls, Pa. 15010

[**] Term: **14 Years**

[21] Appl. No.: **69,242**

[22] Filed: **Mar. 17, 1997**

[51] LOC (6) CL **02-02**

[52] U.S. Cl. **D2/864; D2/861; D2/860**

[58] Field of Search **D2/860, 861, 862,
D2/863, 864; 2/46, 48, 49.1, 49.2, 50, 51,
67, 74, 75, 88, 104, 406**

[56] References Cited

U.S. PATENT DOCUMENTS

D. 155,642	10/1949	Strandhagen	D2/864
D. 362,332	9/1995	Short	D2/861 X
1,093,616	4/1914	Guenzburg	2/46
2,661,471	12/1953	Neumayer	2/46
2,696,616	12/1954	Worcester	2/74
5,181,274	1/1993	DeFiore	2/46
5,491,843	2/1996	Naughton	2/48

Primary Examiner—Louis S. Zarfes
Assistant Examiner—Monica A. Weingart

Attorney, Agent, or Firm—Aileen Champion Addressi

[57] CLAIM

The ornamental design for a nursing blanket, as shown and described.

DESCRIPTION

FIG. 1 is a perspective view of a nursing blanket showing my new design;
 FIG. 2 is a front elevational view thereof;
 FIG. 3 is a rear elevational view thereof;
 FIG. 4 is a right side elevational view thereof;
 FIG. 5 is a left side elevational view thereof;
 FIG. 6 is a bottom plan view thereof;
 FIG. 7 is a top plan view thereof;
 FIG. 8 is a perspective view of an alternate embodiment of my new design including a pocket;
 FIG. 9 is a front elevational view thereof;
 FIG. 10 is a rear elevational view thereof;
 FIG. 11 is a right side elevational view thereof;
 FIG. 12 is a left side elevational view thereof;
 FIG. 13 is a bottom plan view thereof; and,
 FIG. 14 is a top plan view thereof.

The broken line showing of a woman in FIGS. 1 and 8 is for illustrative purposes only and forms no part of the claimed design.

1 Claim, 4 Drawing Sheets

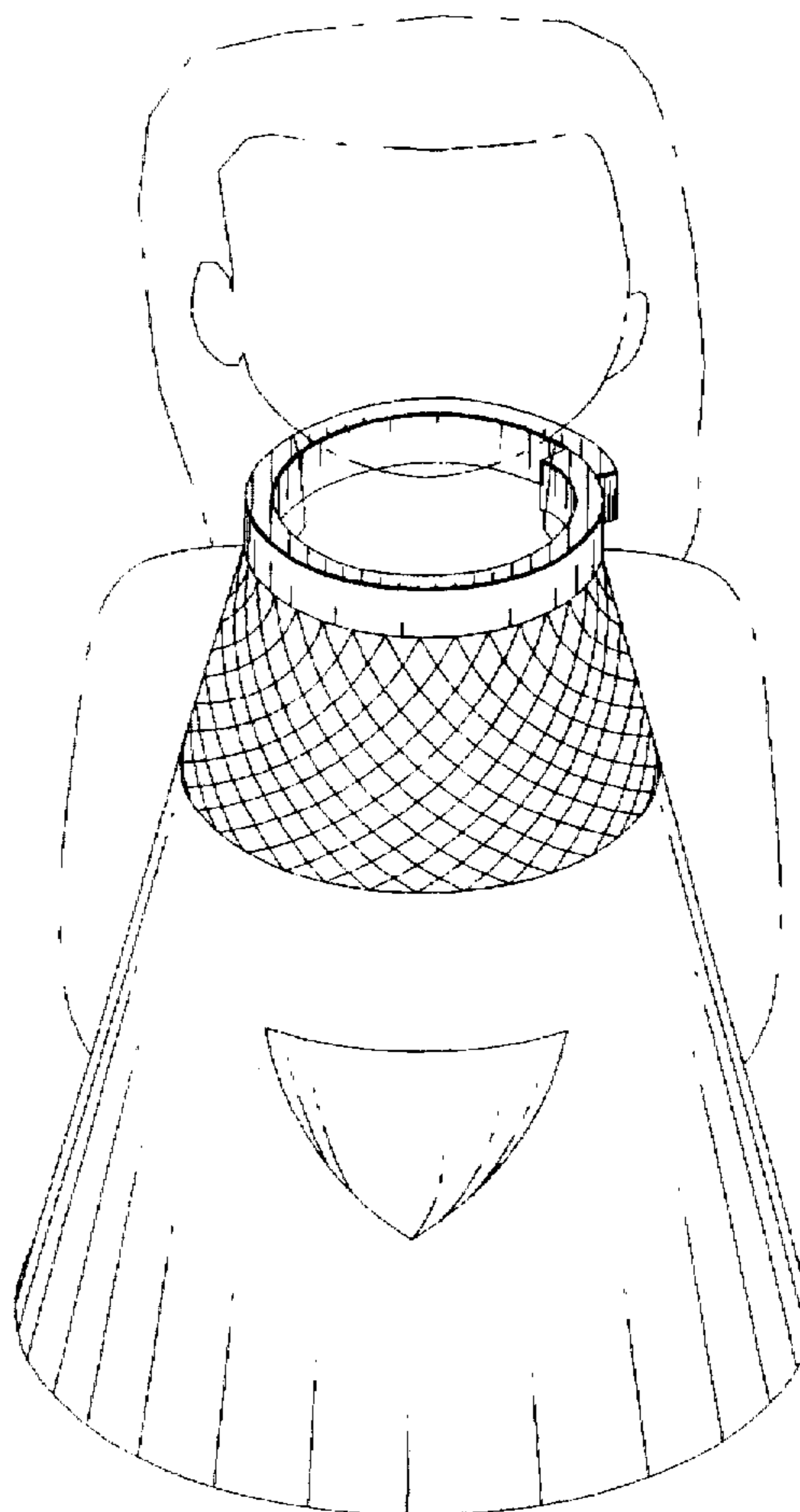
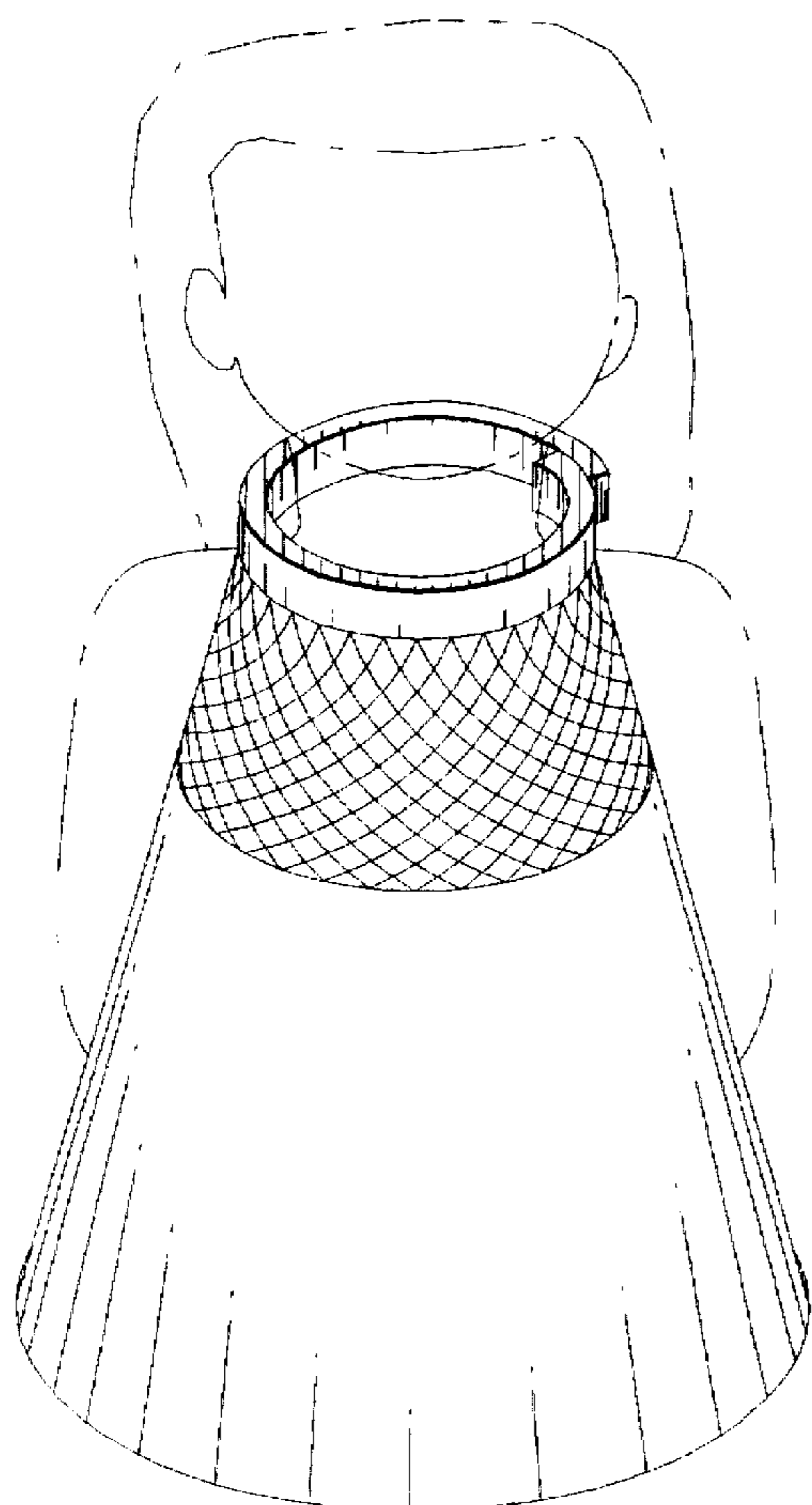

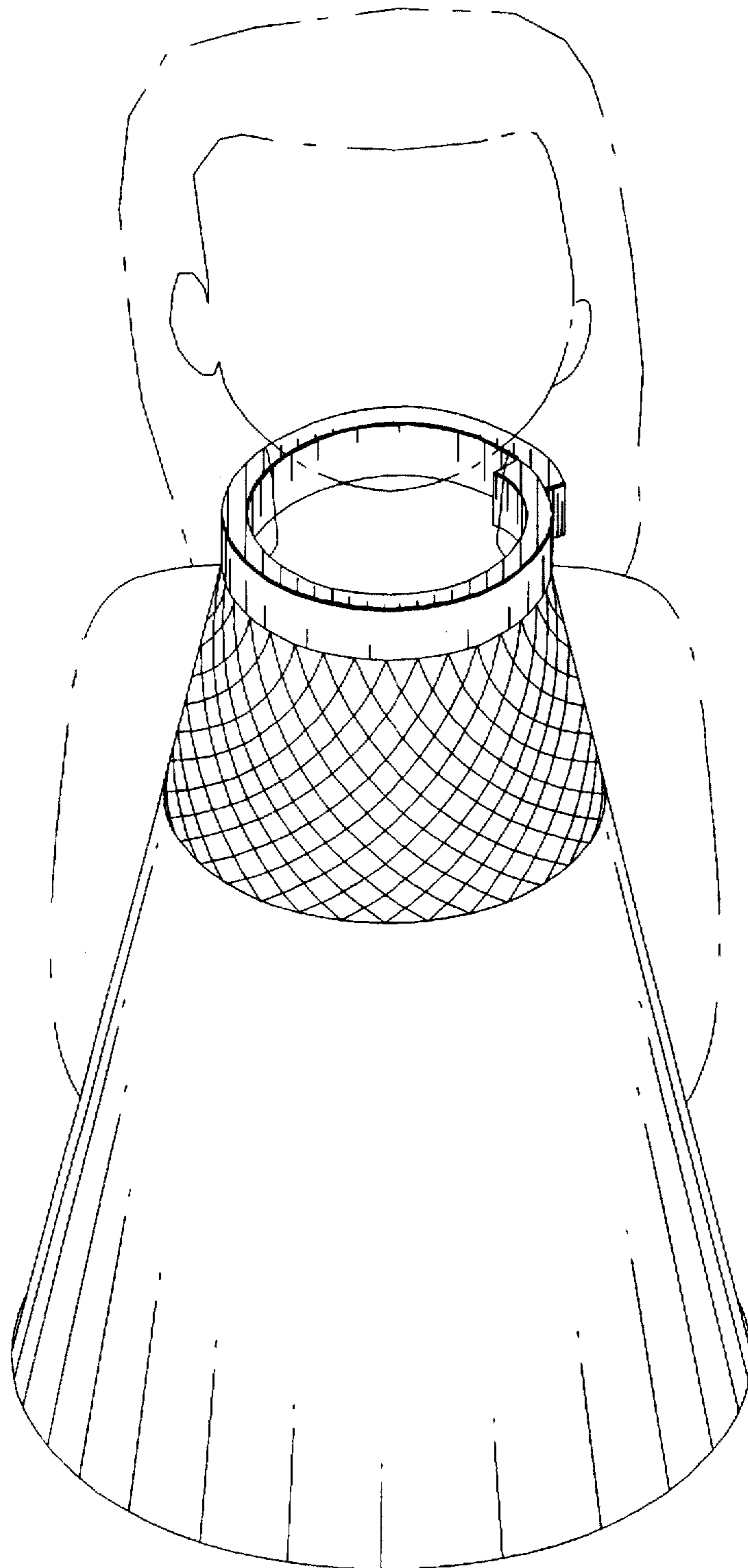

FIG. 1

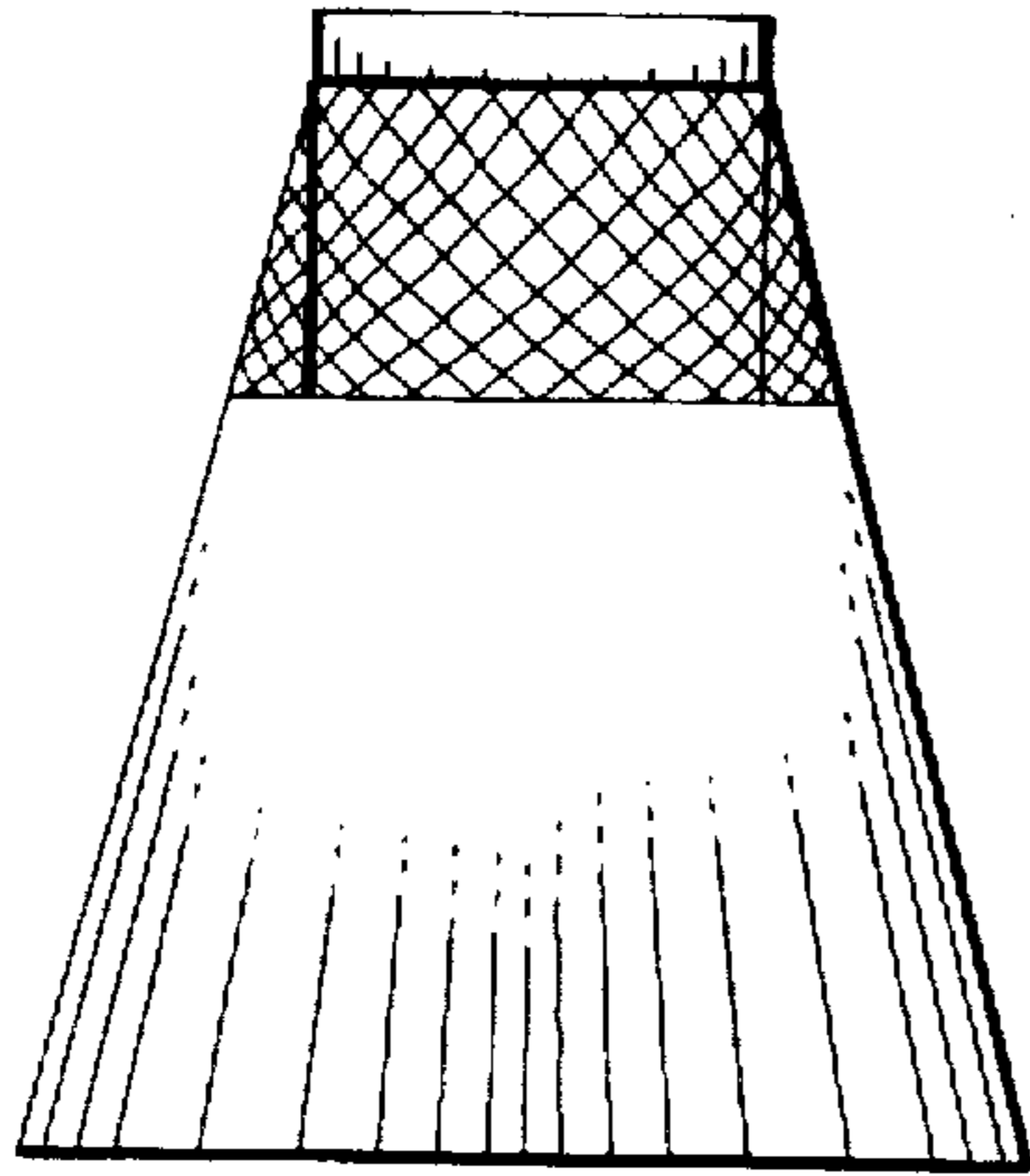

FIG. 2

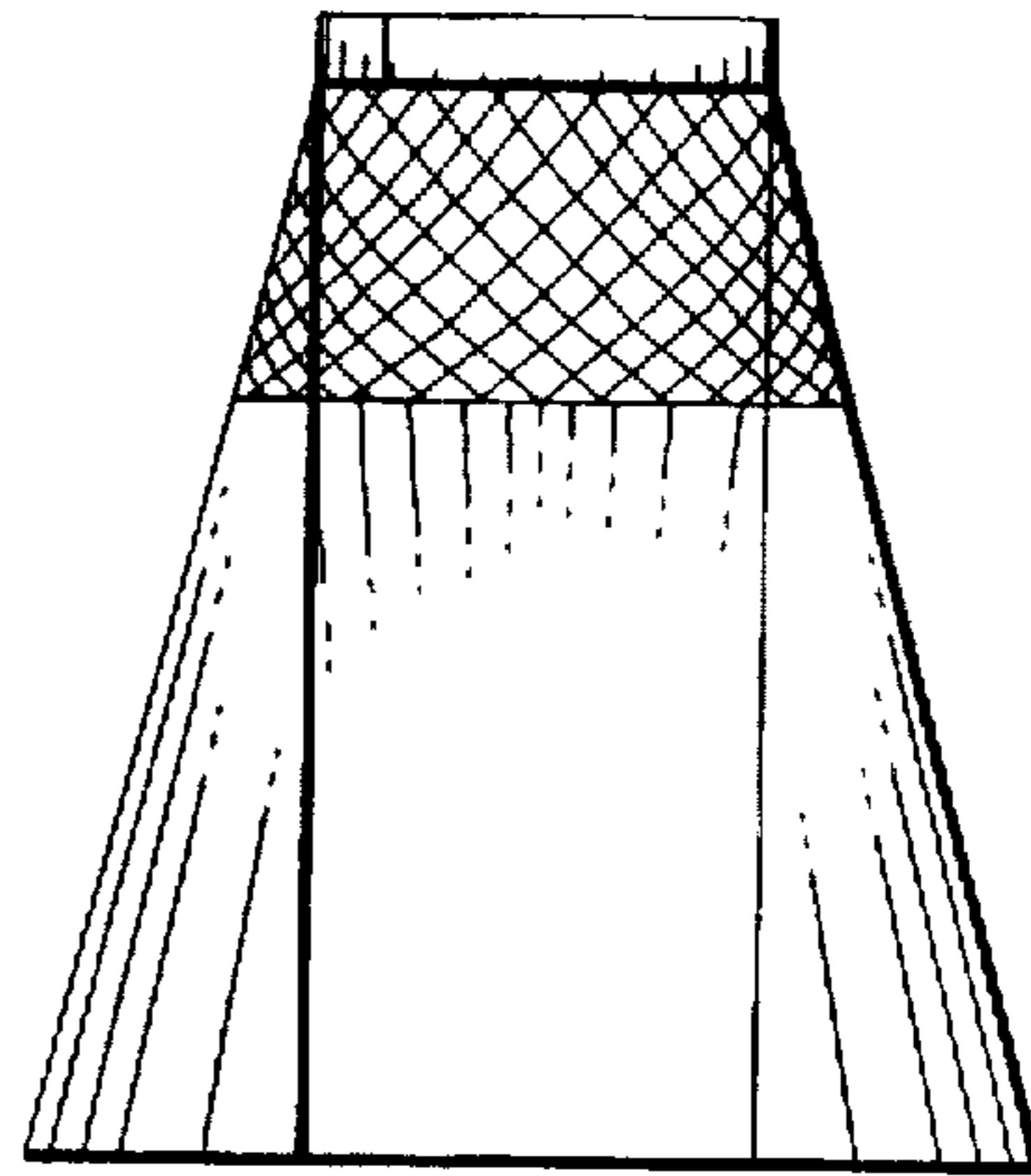

FIG. 3

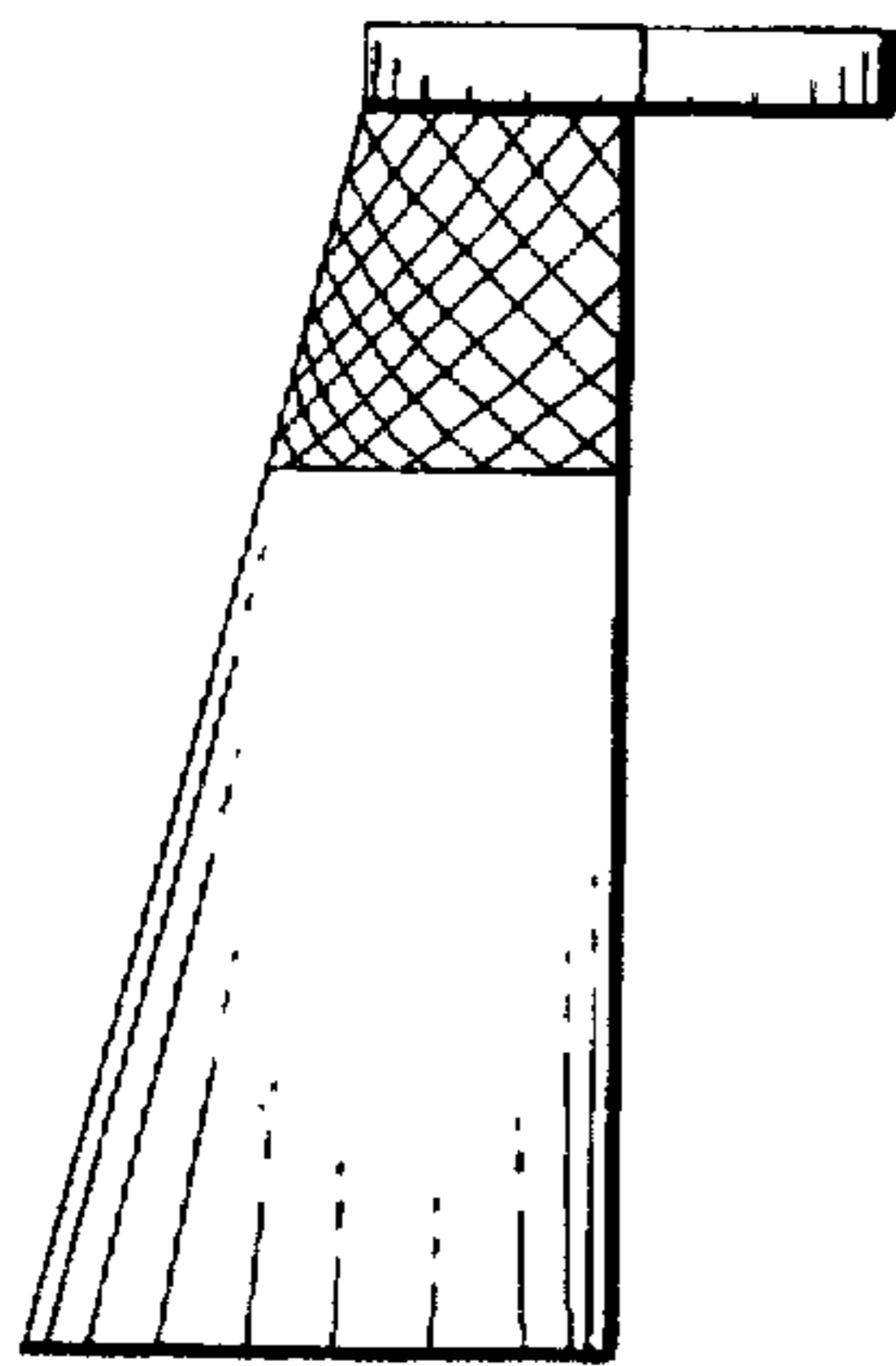

FIG. 4

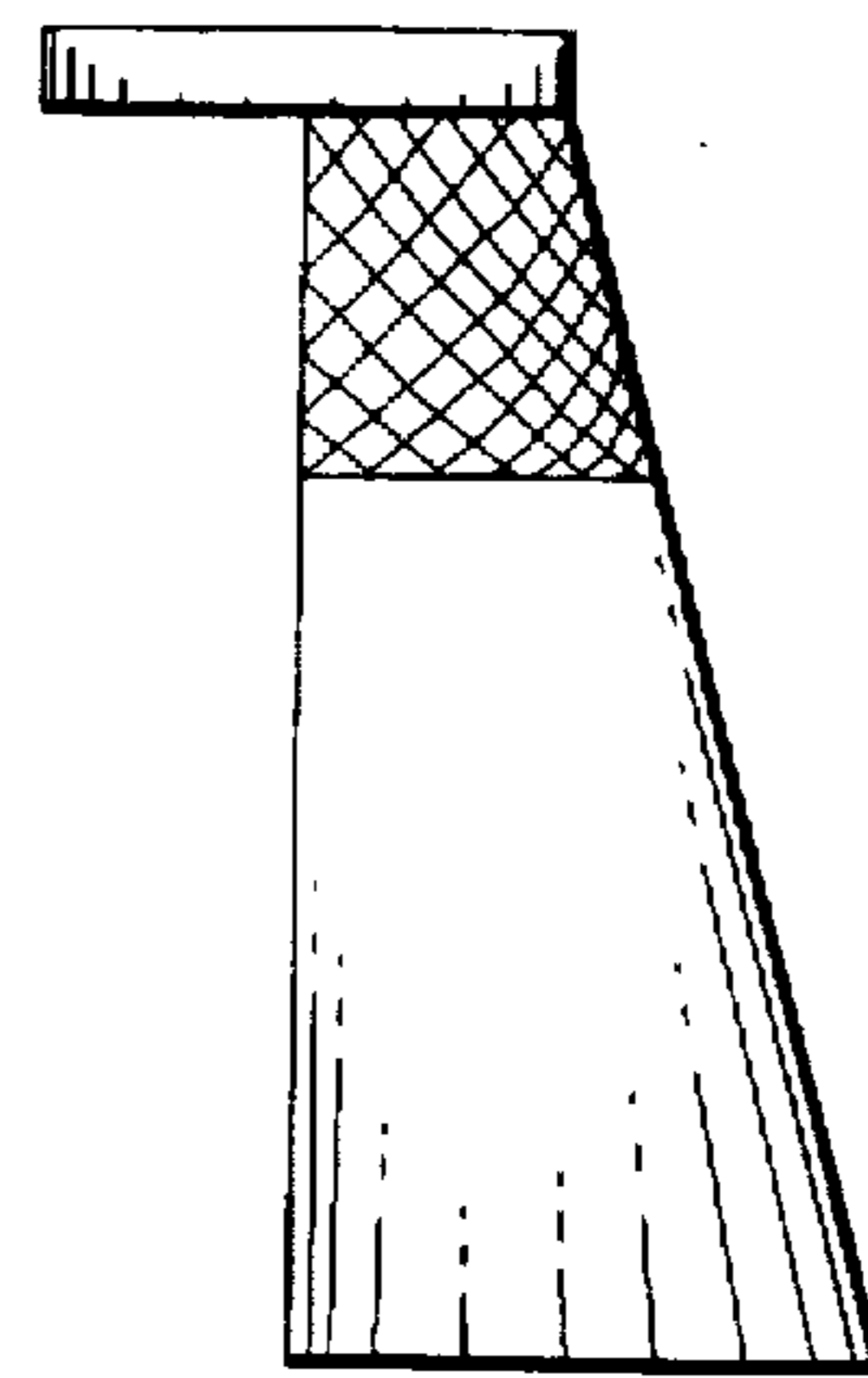

FIG. 5

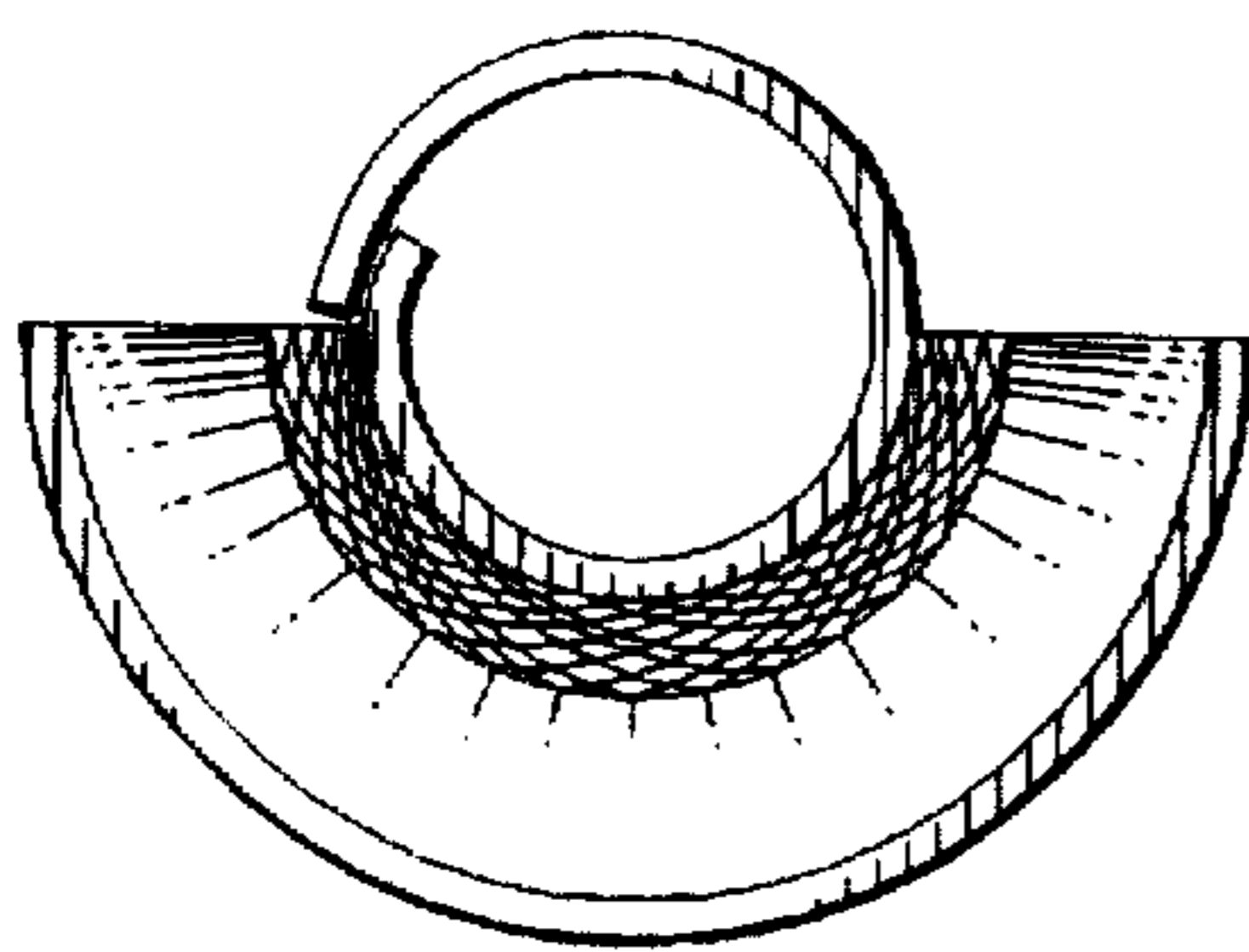

FIG. 6

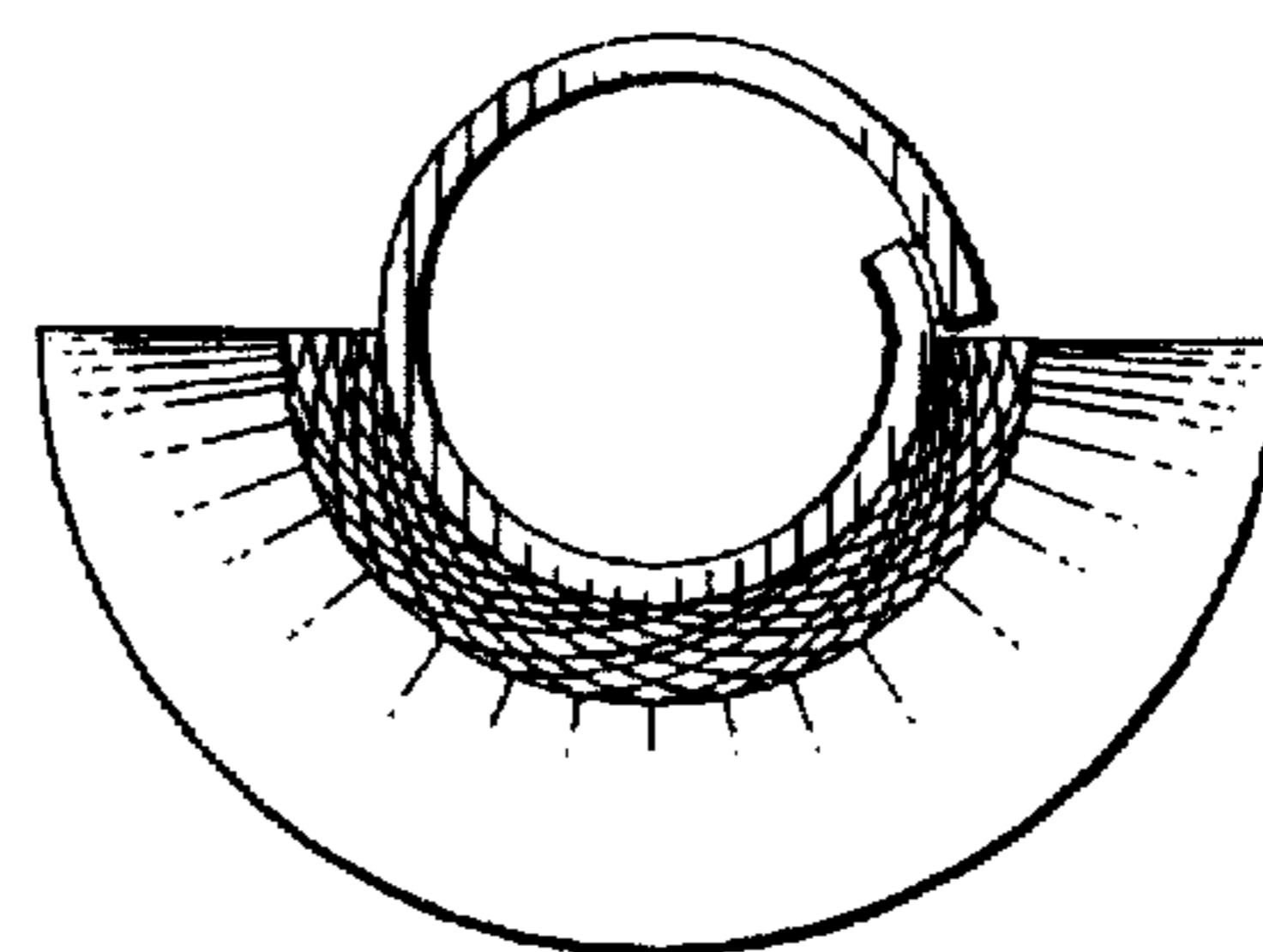

FIG. 7

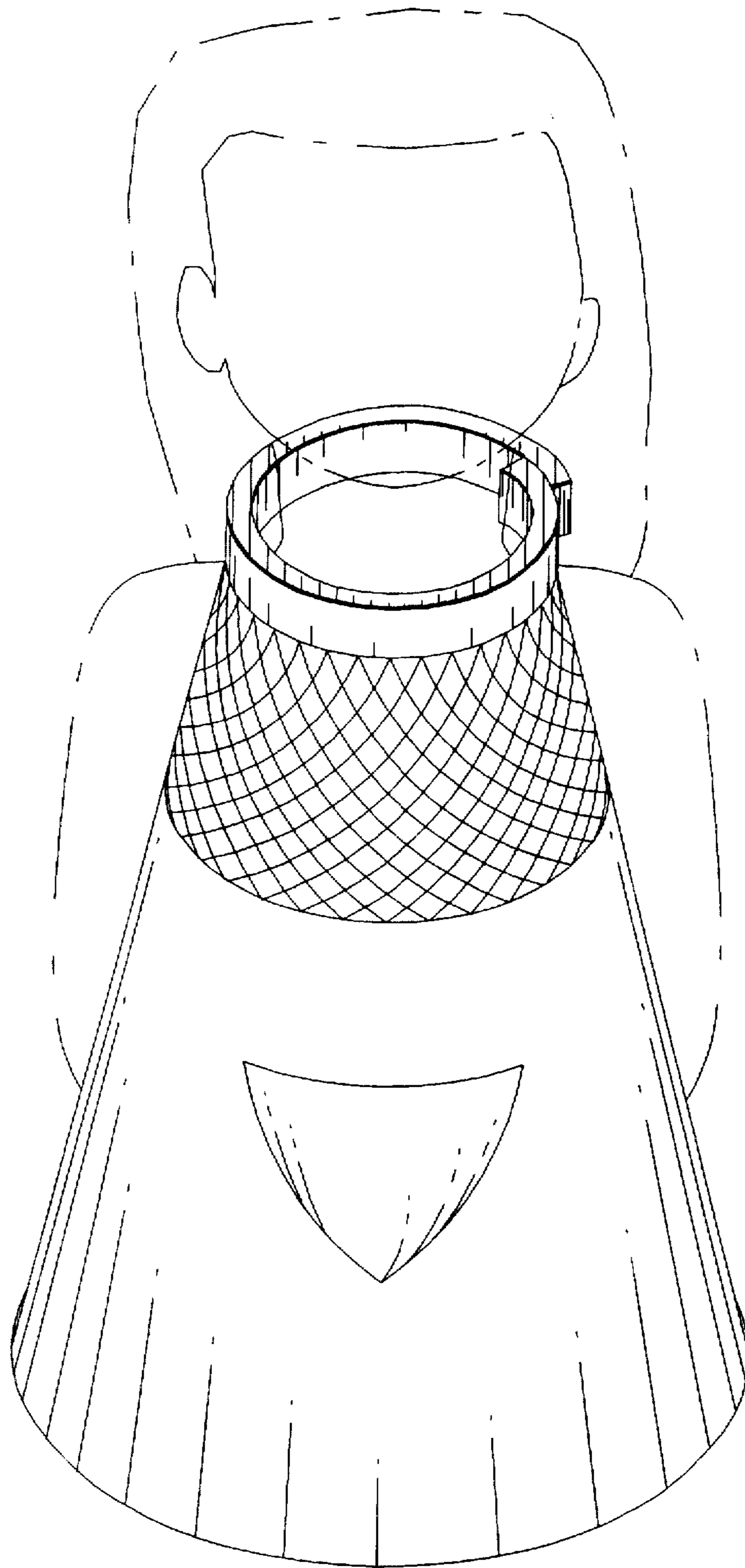

FIG. 8

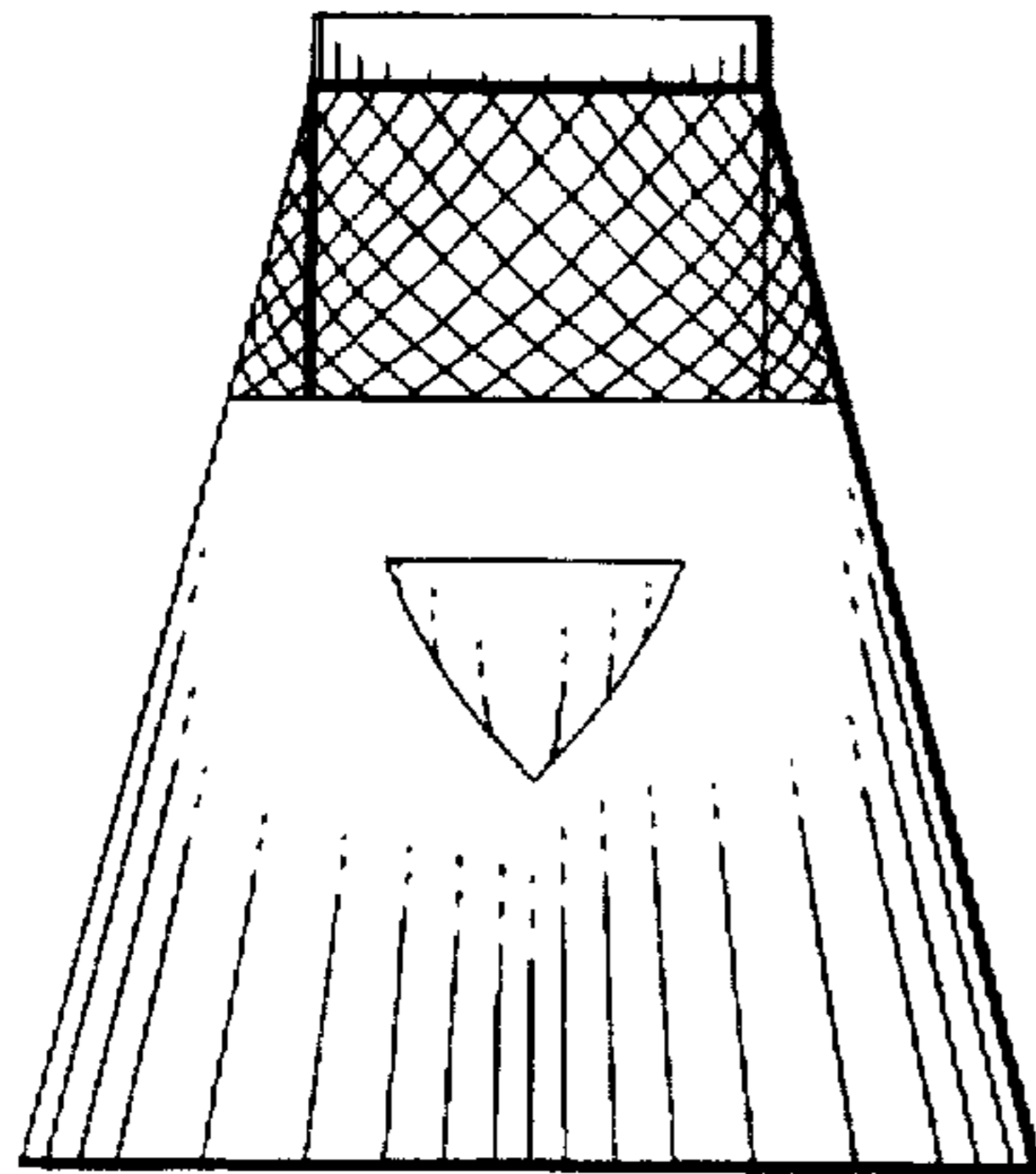

FIG. 9

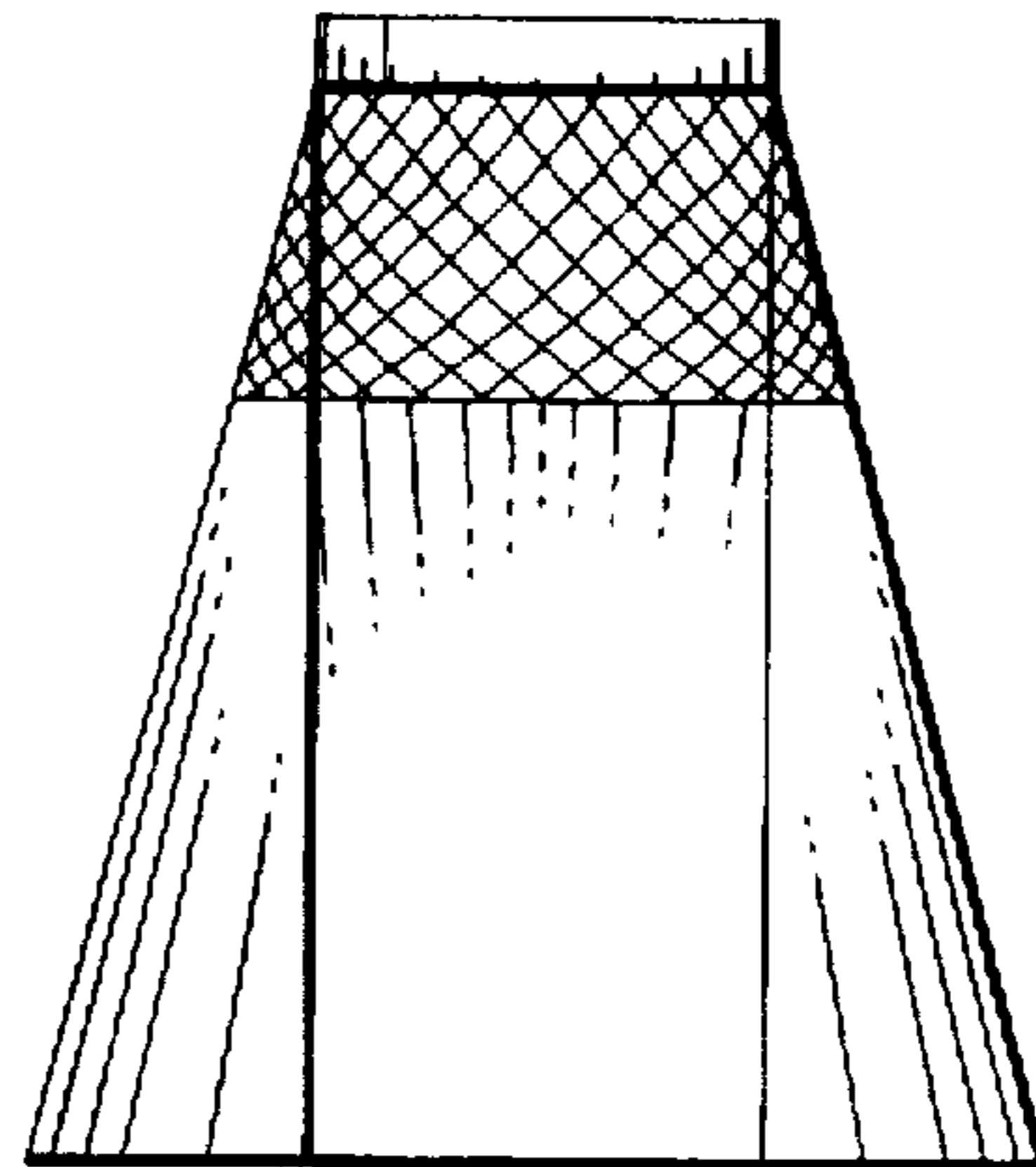

FIG. 10

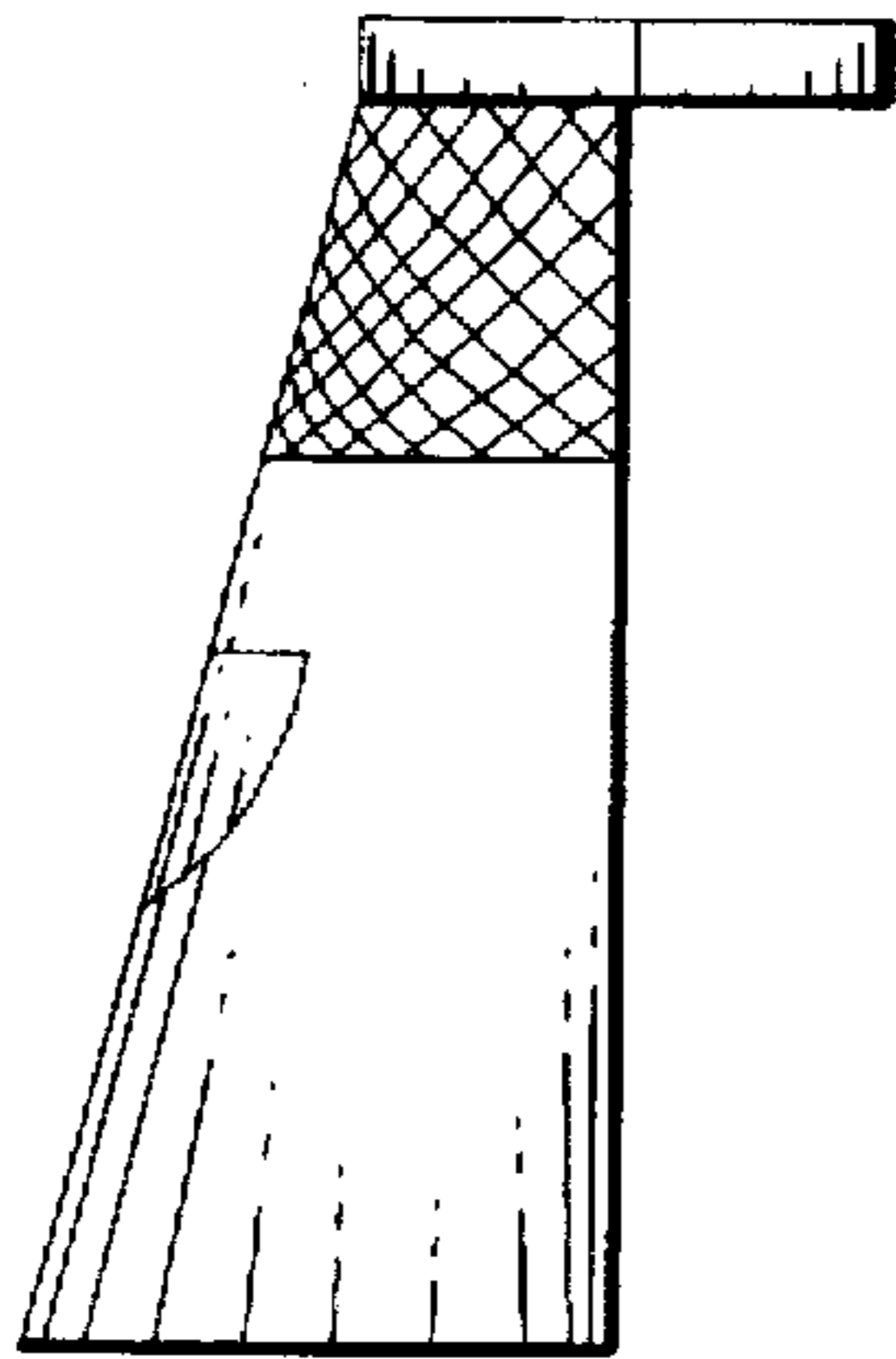

FIG. 11

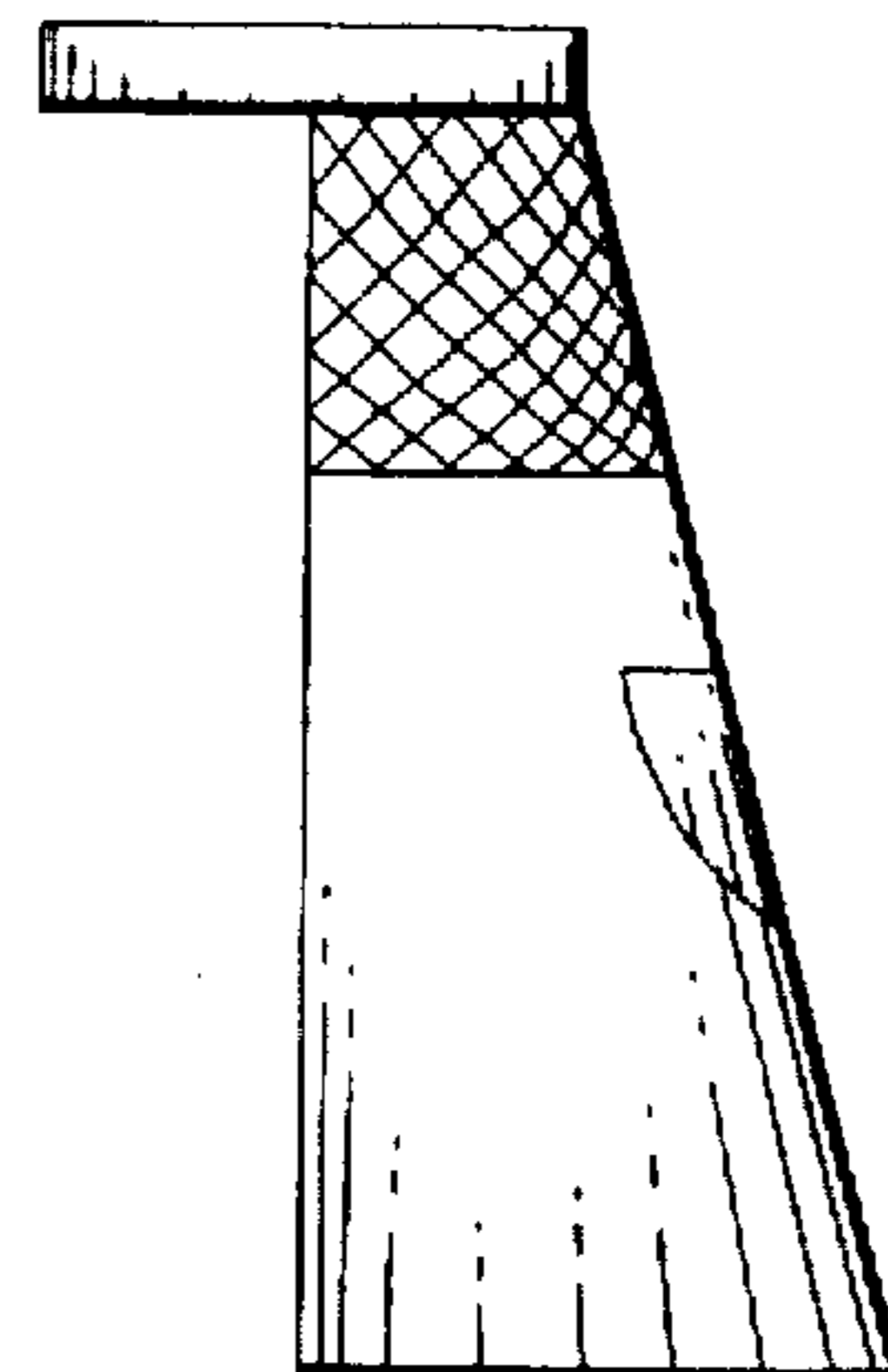

FIG. 12

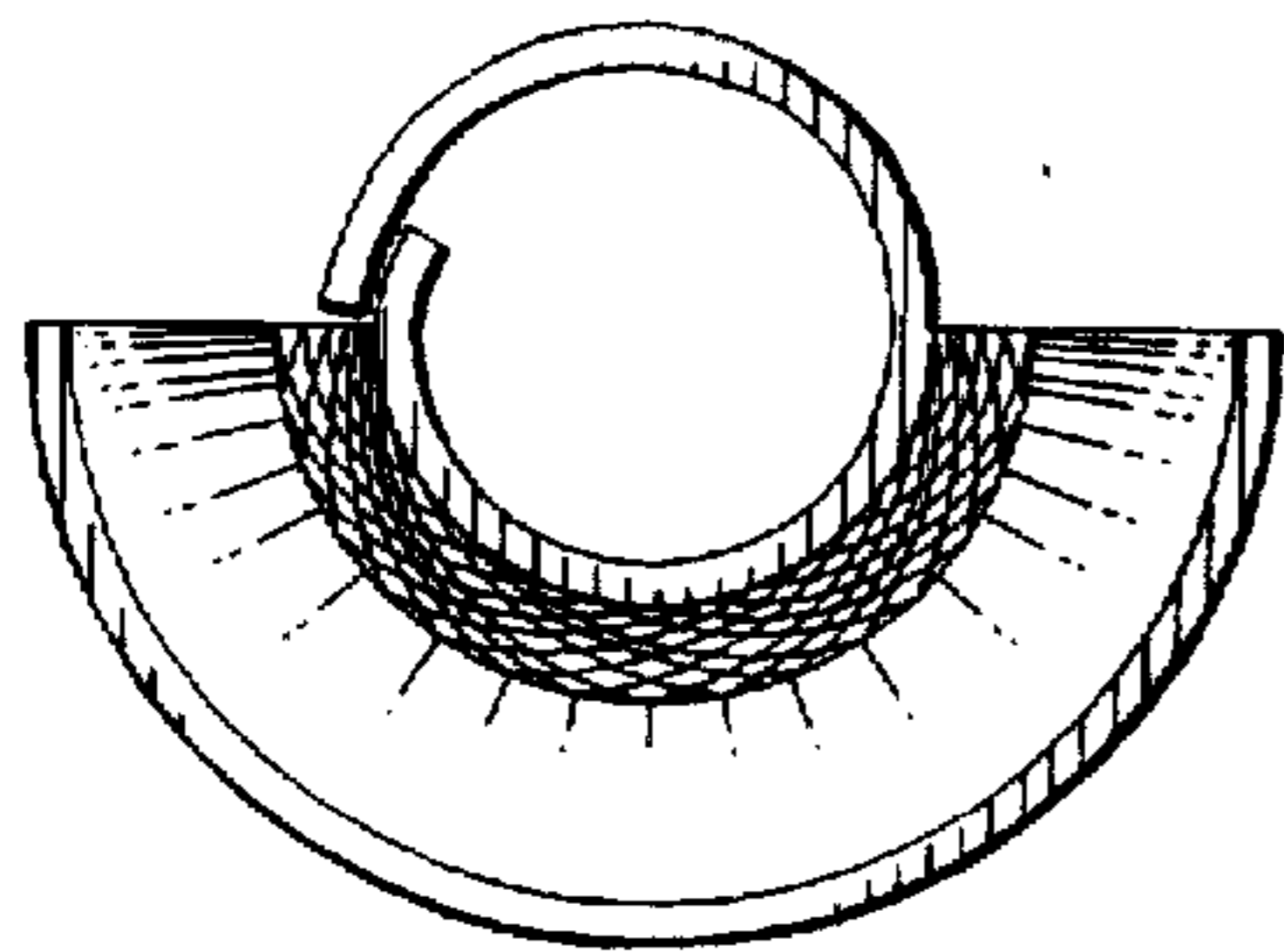

FIG. 13

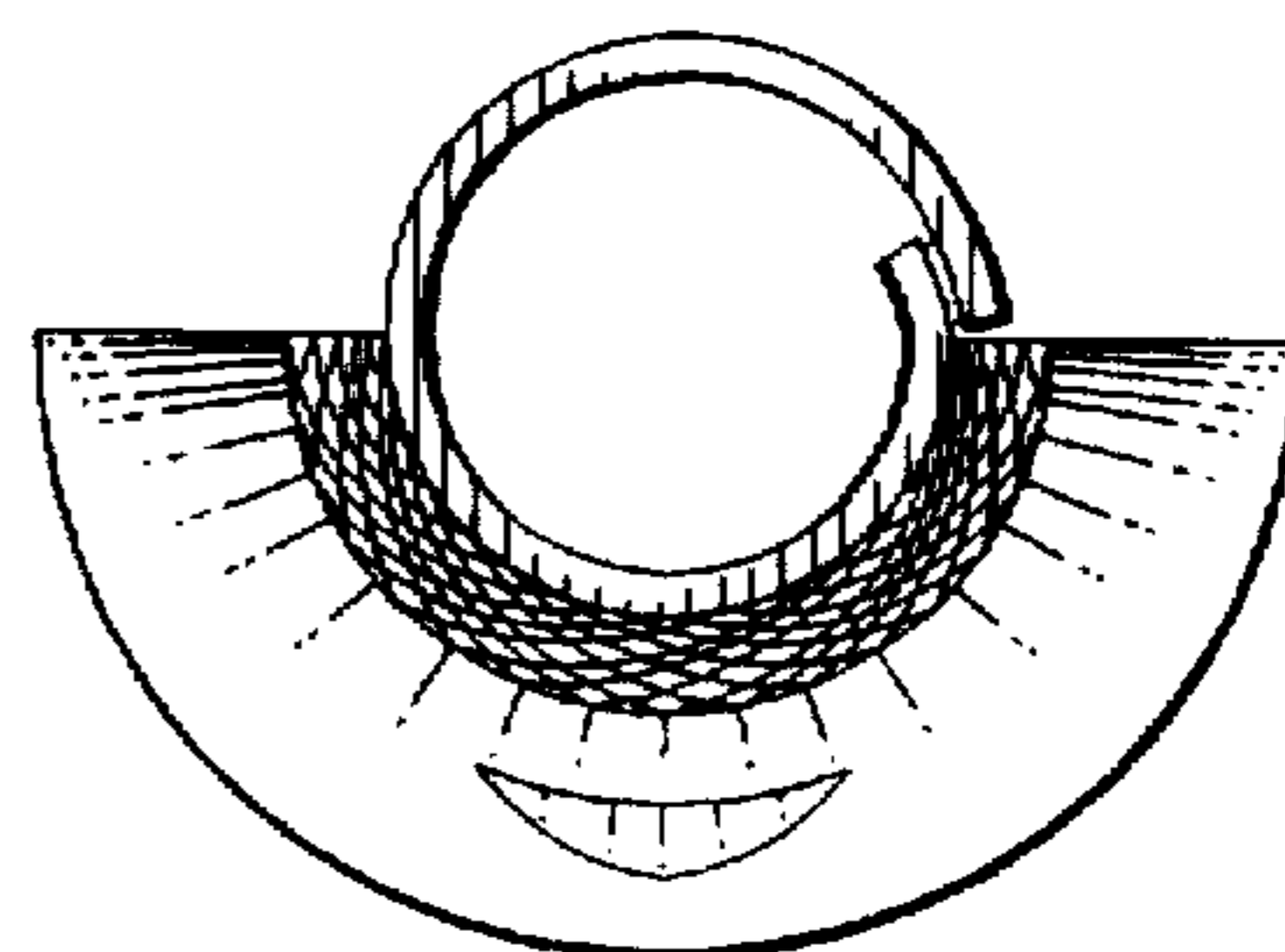

FIG. 14