



US00D393700S

United States Patent [19]

[11] Patent Number: **Des. 393,700**

Trueb et al.

[45] Date of Patent: *****Apr. 21, 1998**

[54] **PROTECTIVE UNDERSINK ENCLOSURE**

4,646,370 3/1987 Risberg et al. D23/308 X
5,253,376 10/1993 Fait 4/661

[75] Inventors: **Thomas W. Trueb; Steven R. Trueb,**
both of Ellington, Conn.

OTHER PUBLICATIONS

[73] Assignee: **Truebro, Inc.,** Ellington, Conn.

Federal Government issued Specification Sheet for Under-Fixture Enclosure, Figures B.418.4 and B4.20.3.1, published in the Federal Register of Jul. 26, 1991.

[*] Notice: The portion of the term of this patent subsequent to Feb. 10, 2012, has been disclaimed.

Primary Examiner—Louis S. Zarfes
Assistant Examiner—Eric Waterson
Attorney, Agent, or Firm—Ira S. Dorman

[**] Term: **14 Years**

[57] CLAIM

[21] Appl. No.: **54,347**

The ornamental design for a protective undersink enclosure, as shown.

[22] Filed: **May 13, 1996**

Related U.S. Application Data

DESCRIPTION

[63] Continuation-in-part of Ser. No. 43,128, Aug. 25, 1995, Pat. No. Des. 384,732, Ser. No. 40,563, Jun. 21, 1995, Pat. No. Des. 373,412, and Ser. No. 40,564, Jun. 21, 1995, Pat. No. Des. 372,077.

FIG. 1 is a perspective view of the protective undersink enclosure of the invention;

[51] **LOC (6) Cl.** **23-02**

[52] **U.S. Cl.** **D23/308**

FIG. 2 is a side elevational view of the protective undersink enclosure of the invention, the other side being a mirror image thereof;

[58] **Field of Search** D23/295-299,
D23/302-311; 4/661, 654, 311

FIG. 3 is a top view of the protective undersink enclosure of the invention;

FIG. 4 is a front view of the protective undersink enclosure of the invention;

FIG. 5 is a bottom view of the protective undersink enclosure of the invention; and,

FIG. 6 is a rear view of the protective undersink enclosure of the invention.

[56] References Cited

U.S. PATENT DOCUMENTS

D. 258,683 3/1981 Wilson D23/308
D. 358,634 5/1995 Dannenberg et al. D23/308
D. 375,154 10/1996 Trueb et al. D23/308

1 Claim, 3 Drawing Sheets

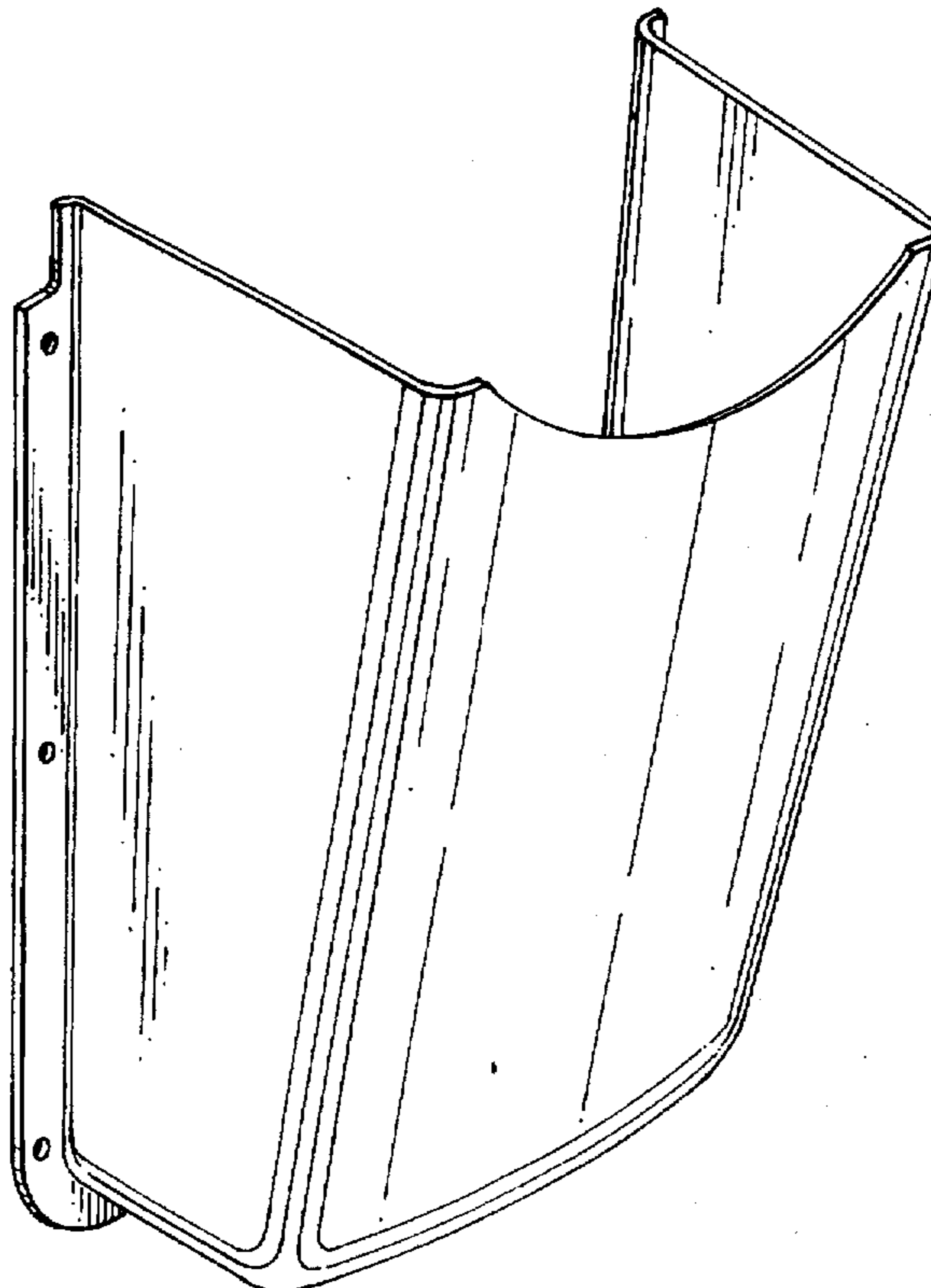

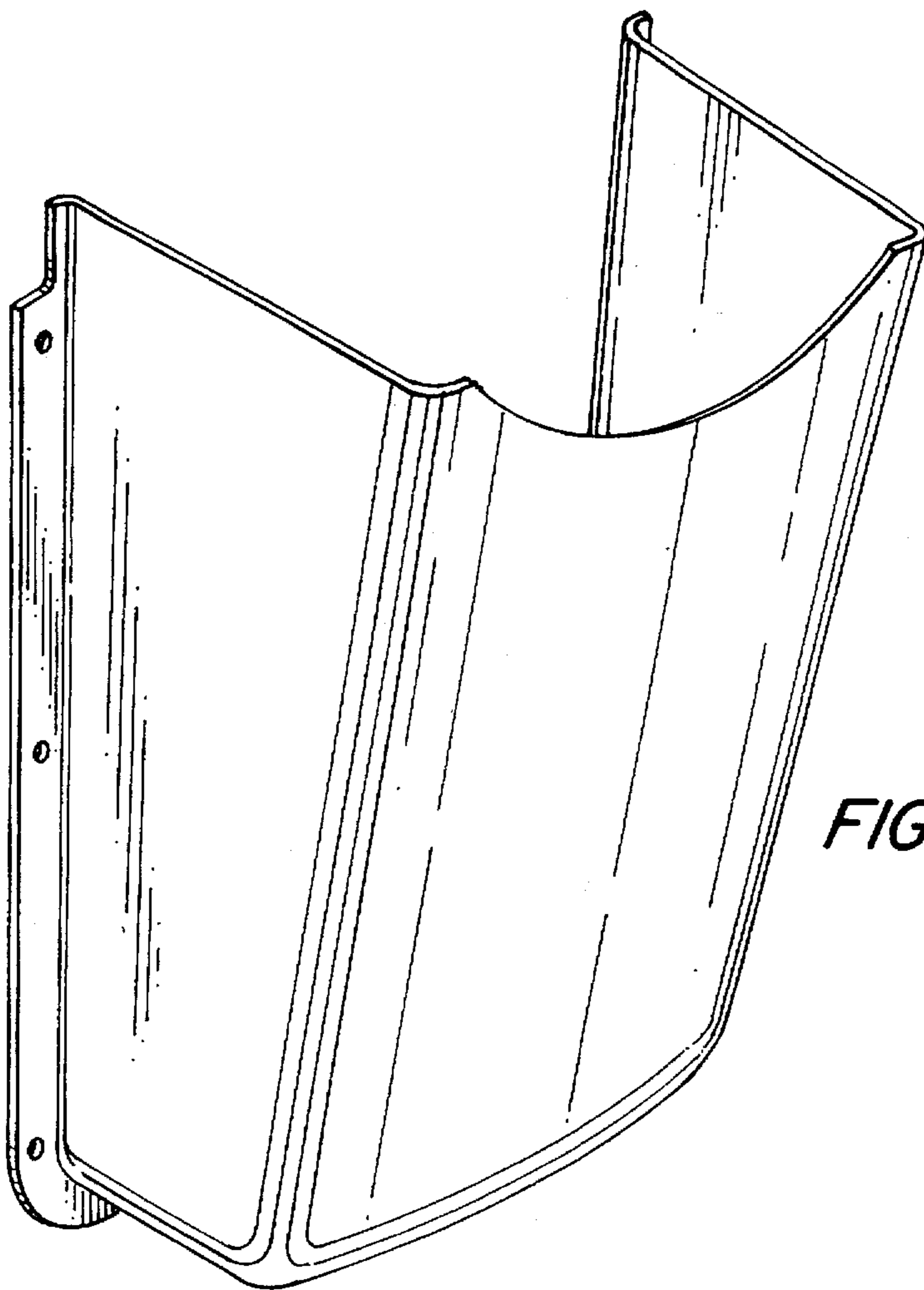

FIG. 1

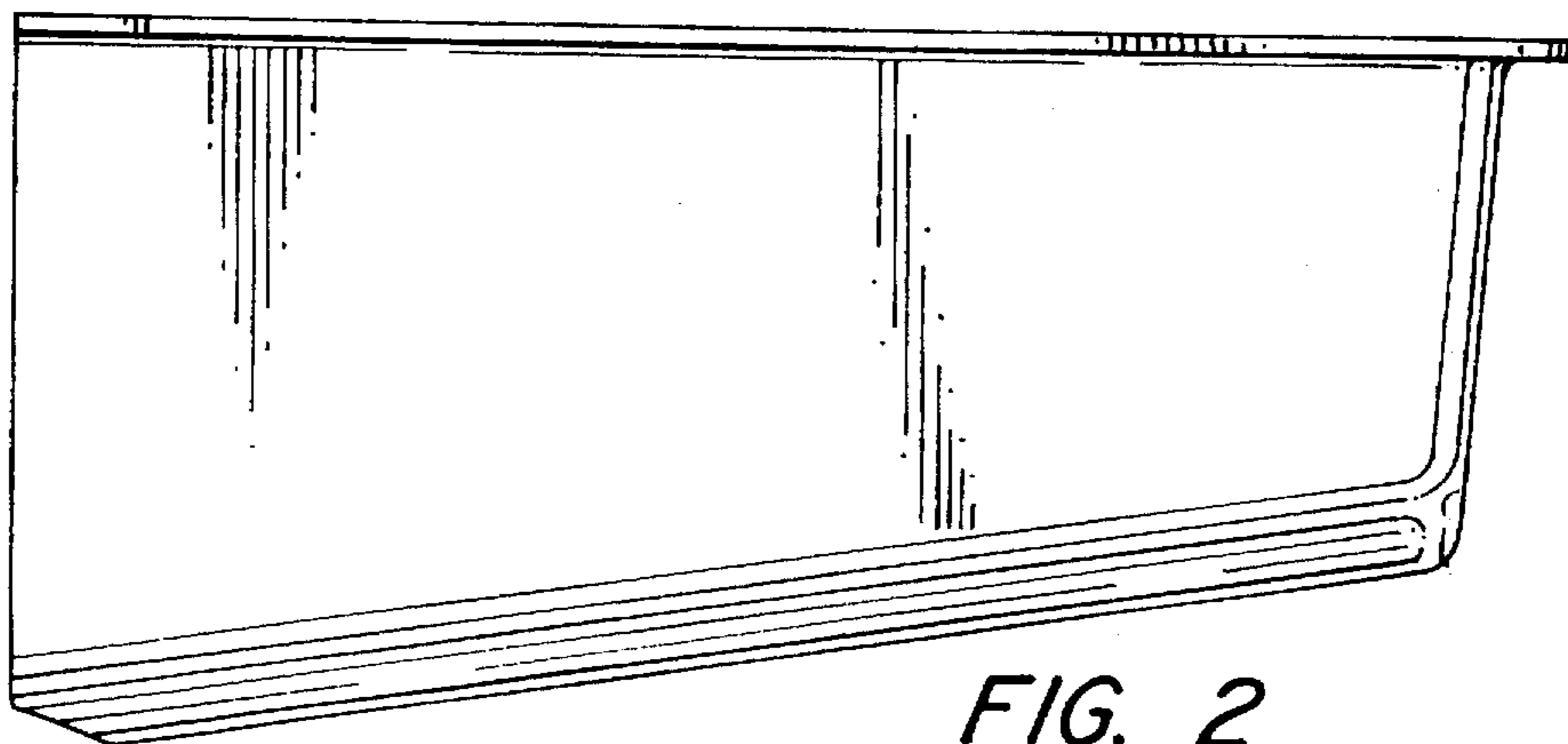

FIG. 2

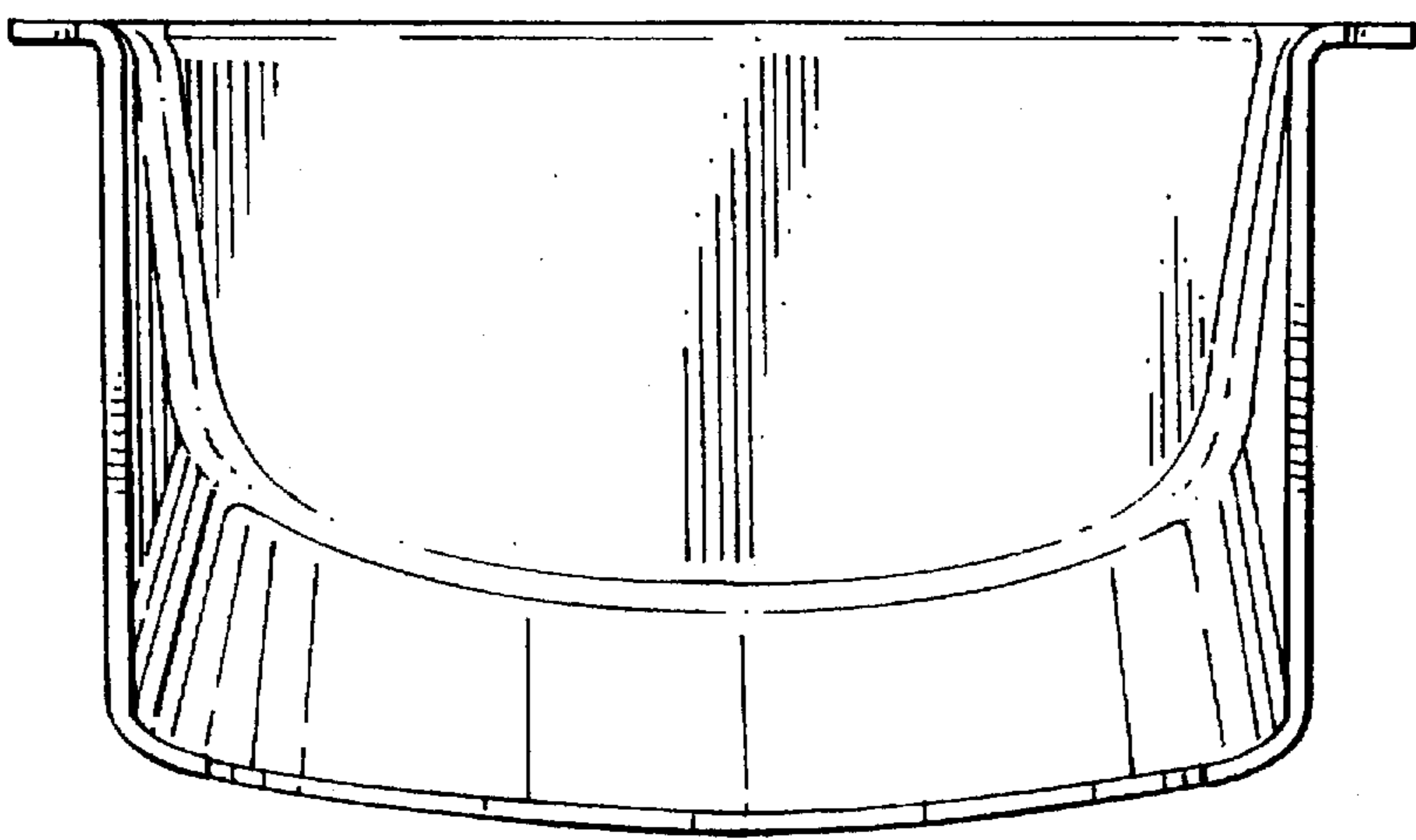

FIG. 3

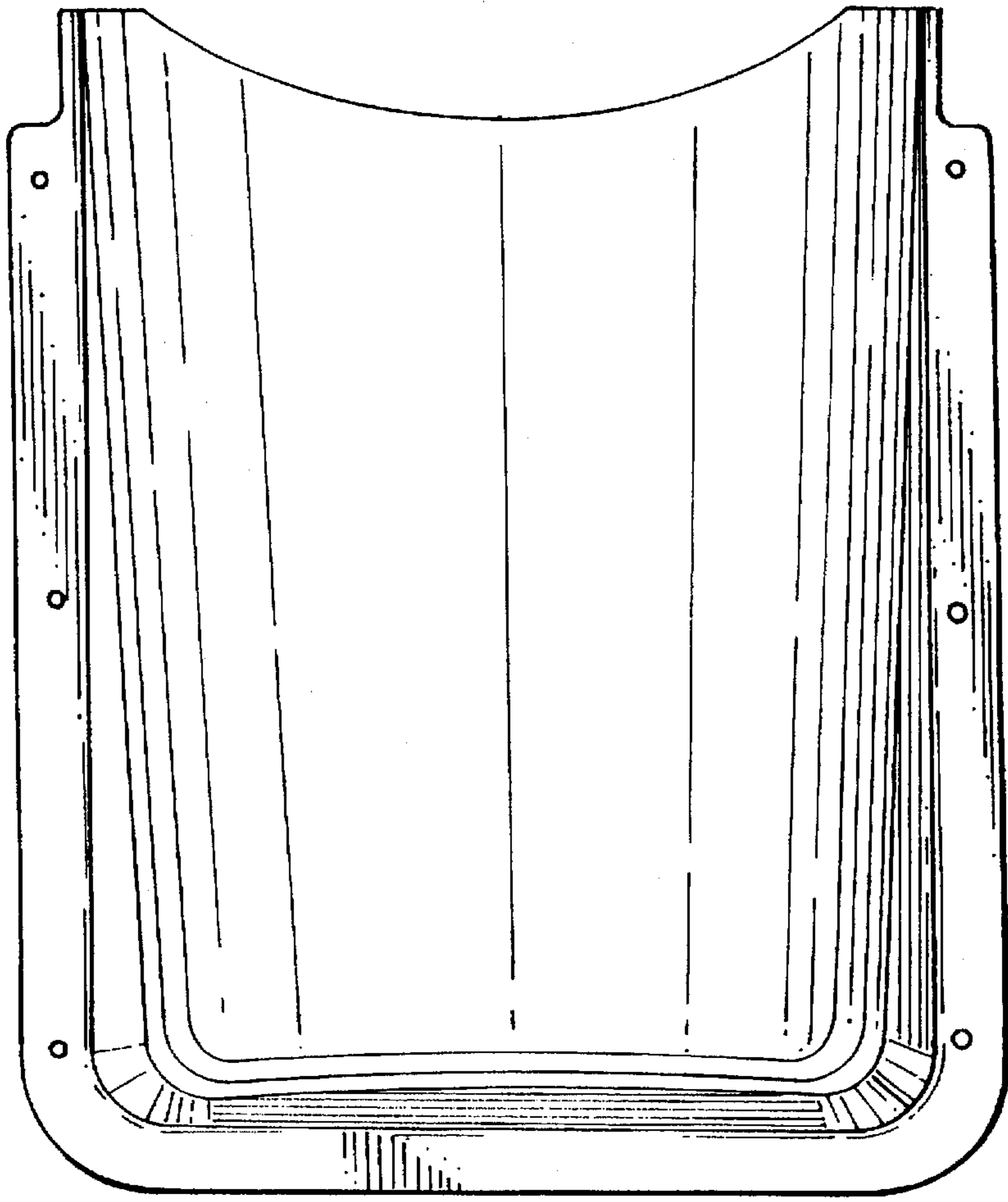

FIG. 4

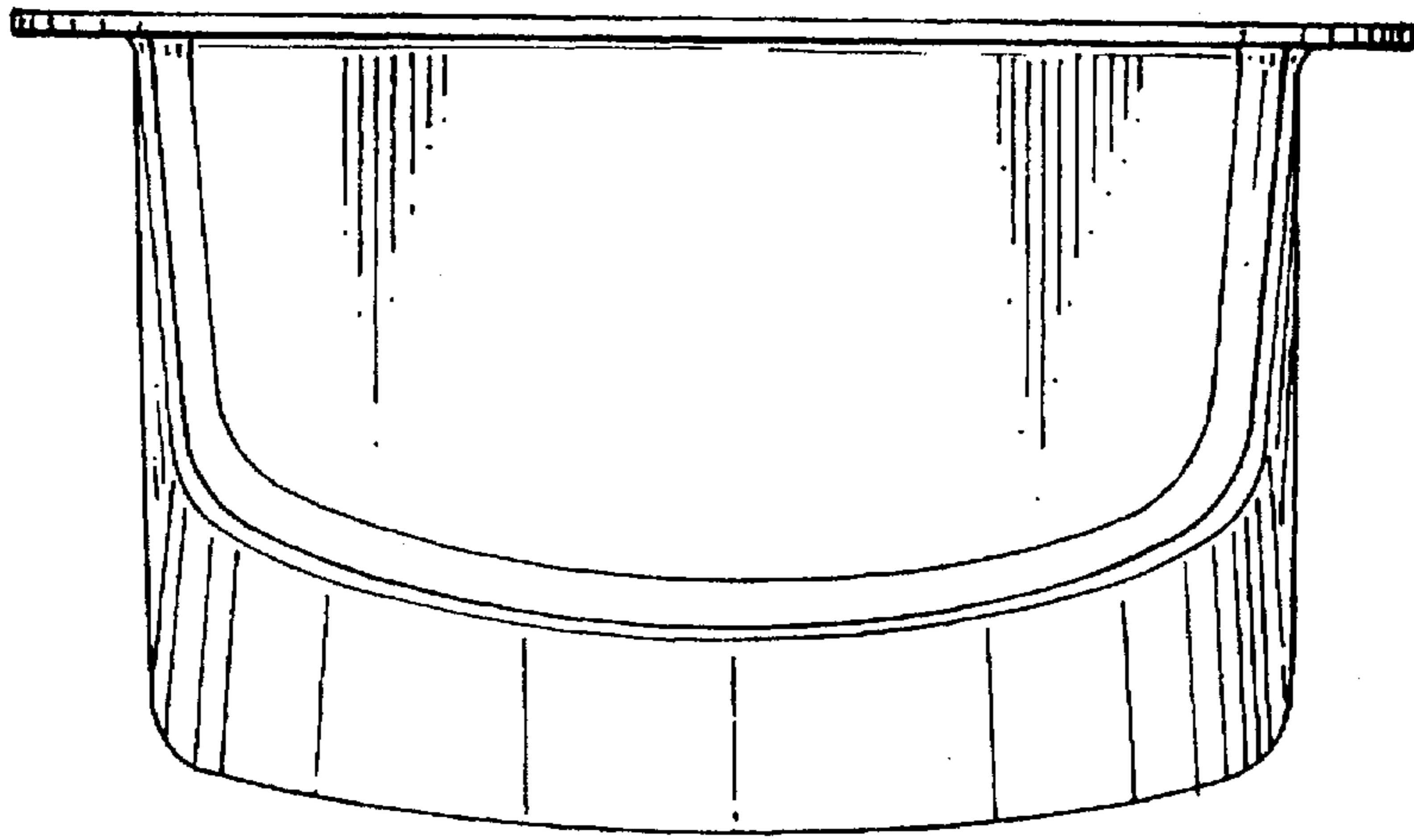

FIG. 5

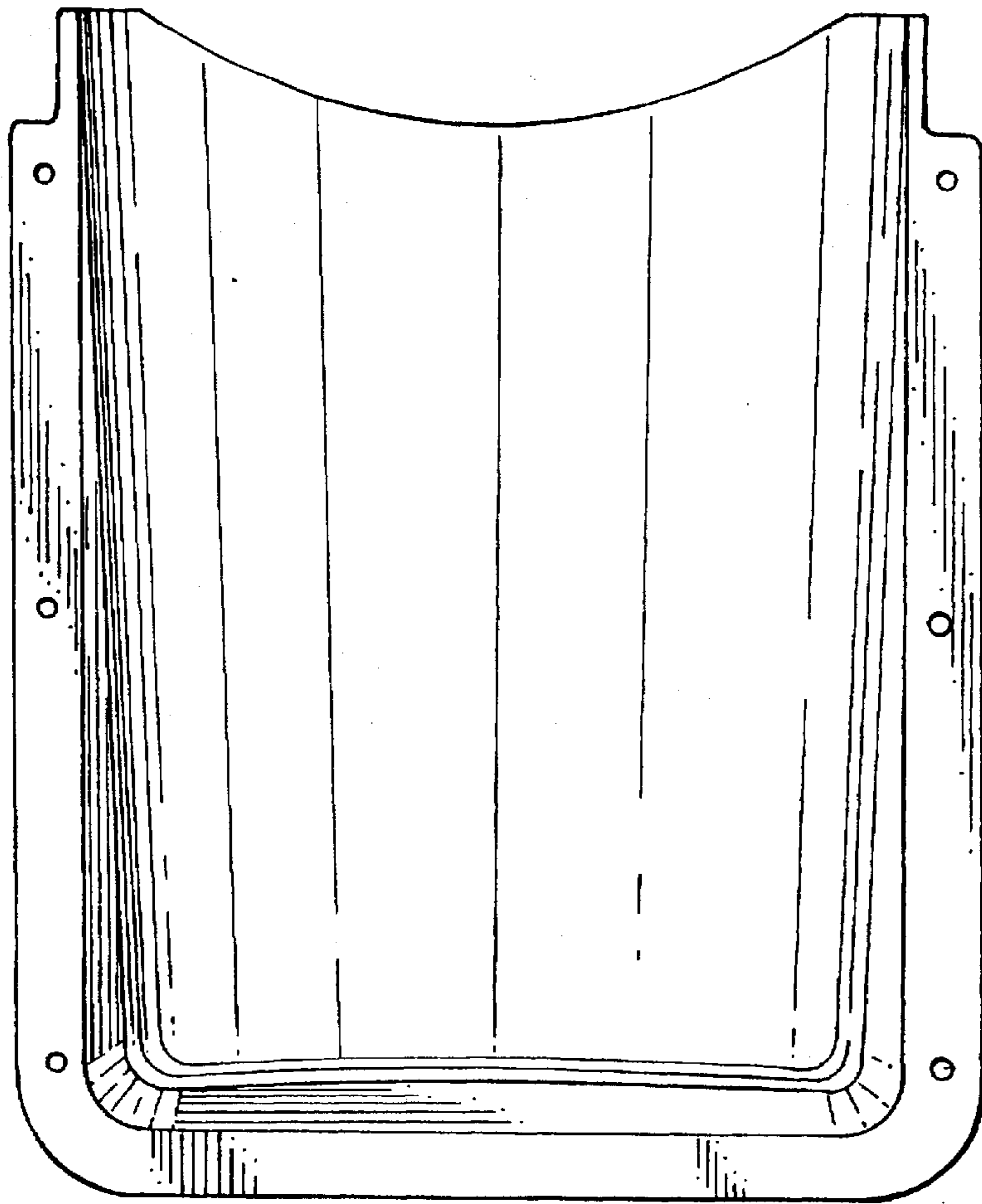

FIG. 6